



21061





LEGO.com/sustainable-packaging



FR
**DONNEZ
OU
RECYCLEZ**



ASSOCIATION

OU



MAGASIN

OU



DÉCHÈTERIE

Adresses sur quefairedemesdechets.fr



BUILDER



Apple and the Apple logo are trademarks of Apple Inc., registered in the U.S. and other countries and regions. App Store is a service mark of Apple Inc. Google Play and the Google Play logo are trademarks of Google LLC. Tencent and the Tencent logo are trademarks of Tencent Inc.

LEGO.com/devicecheck



LEGO® Builder



CATEDRAL DE NOTRE DAME DE PARÍS

☞ "Es difícil imaginar París sin la majestuosa Catedral de Notre Dame. Este espectacular hito emblemático, que a lo largo de los siglos ha resistido los embates de los elementos, una revolución y acontecimientos devastadores, sigue siendo una de las atracciones turísticas más populares de París. Vista en todo su esplendor, es imposible no preguntarse cómo lograron arquitectos, albañiles y constructores crear hace casi 900 años semejante monumento que parece desafiar la gravedad, con una construcción que se prolongó durante siglos. Inspirados y asombrados por las ingeniosas técnicas empleadas por estos artesanos, nos propusimos 'traducir' esta imponente edificación y sus elaborados detalles en un modelo LEGO®".

"Estas instrucciones te guiarán en todo el proceso de construcción: cada ladrillo está colocado de forma precisa para corresponderse con elementos arquitectónicos específicos de la catedral original. Con cada bolsa que completes, verás un modelo de un momento específico de la construcción de la catedral, desde 1163 hasta hoy".

Rok Žgalin Kobe, diseñador sénior de LEGO®

1163-1182

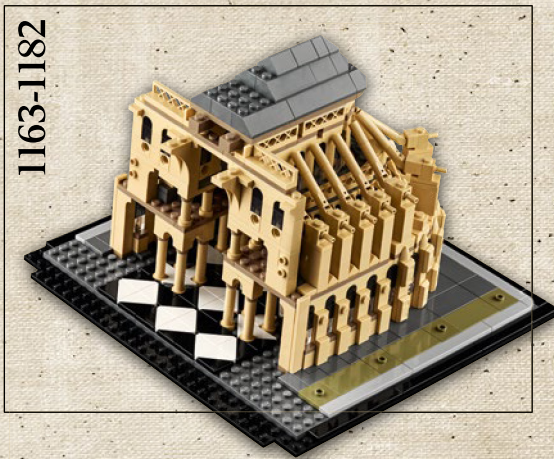

1163-1182: El lado oriental, que fue el que se terminó primero, funcionó como iglesia mientras la construcción proseguía en el resto de la catedral.

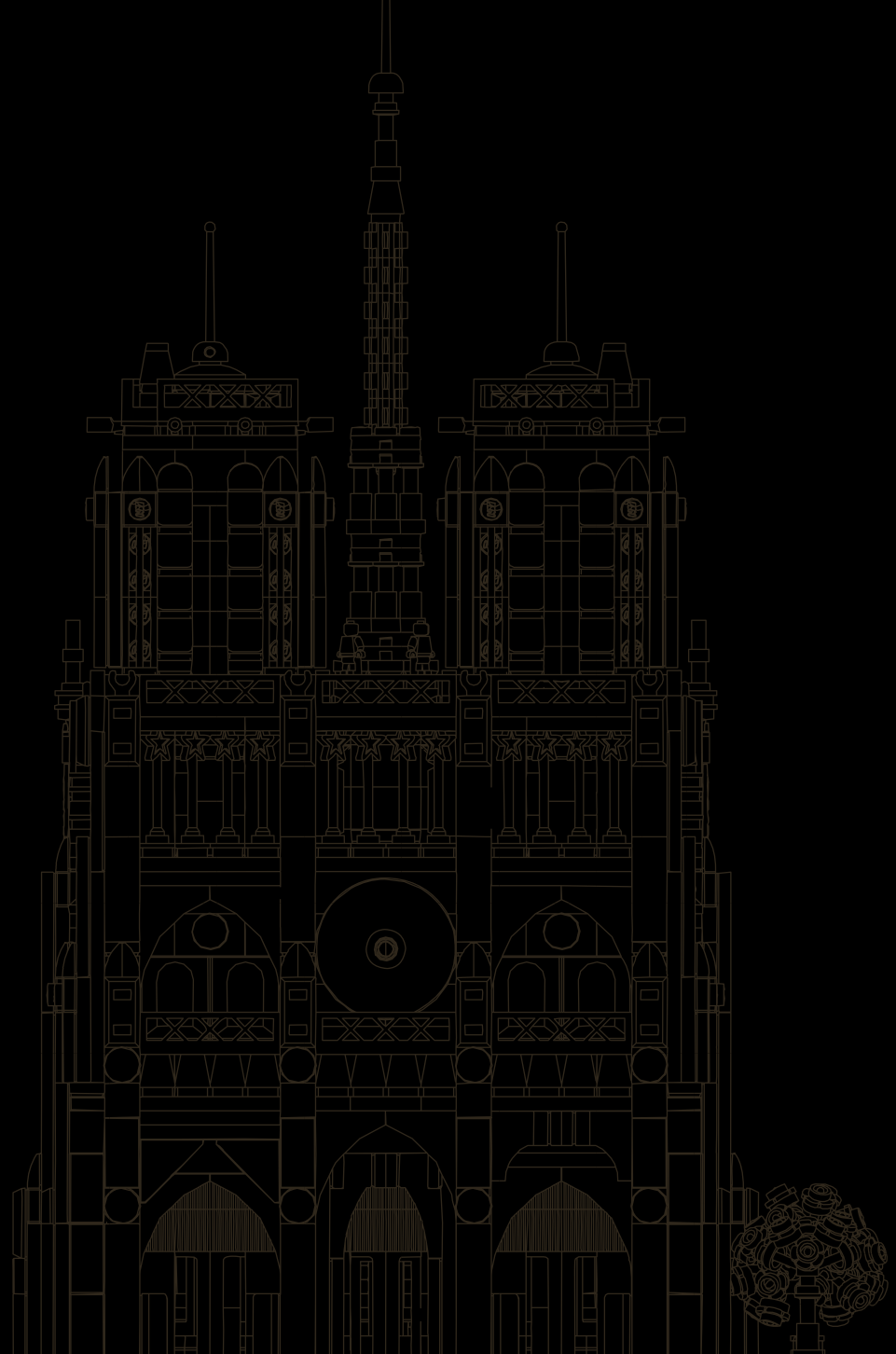

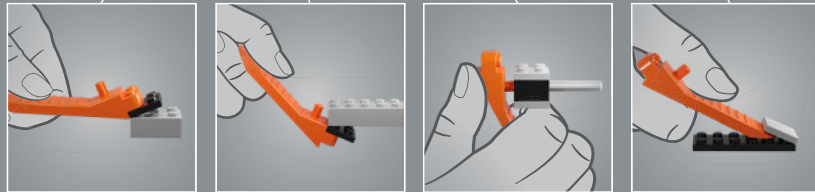
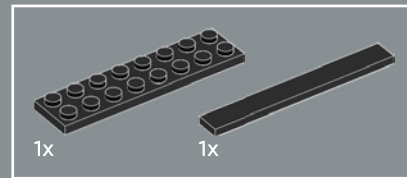
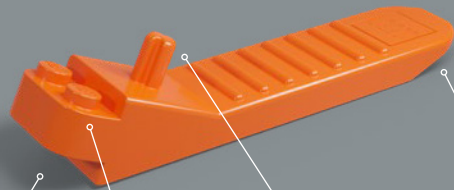

1

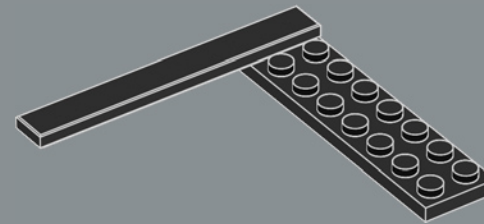

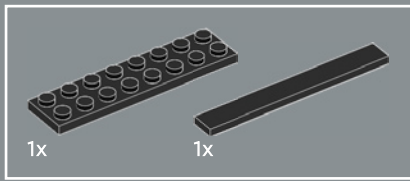

2

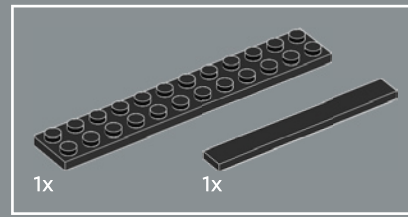
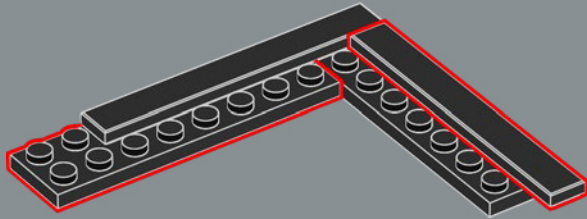

3

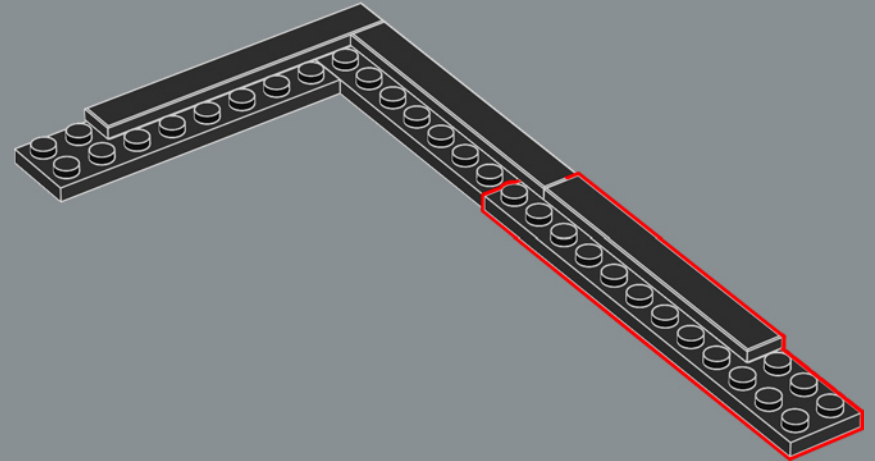

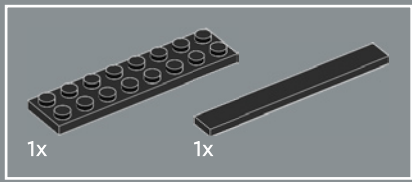

4

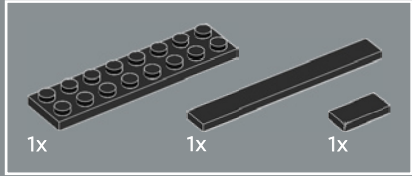
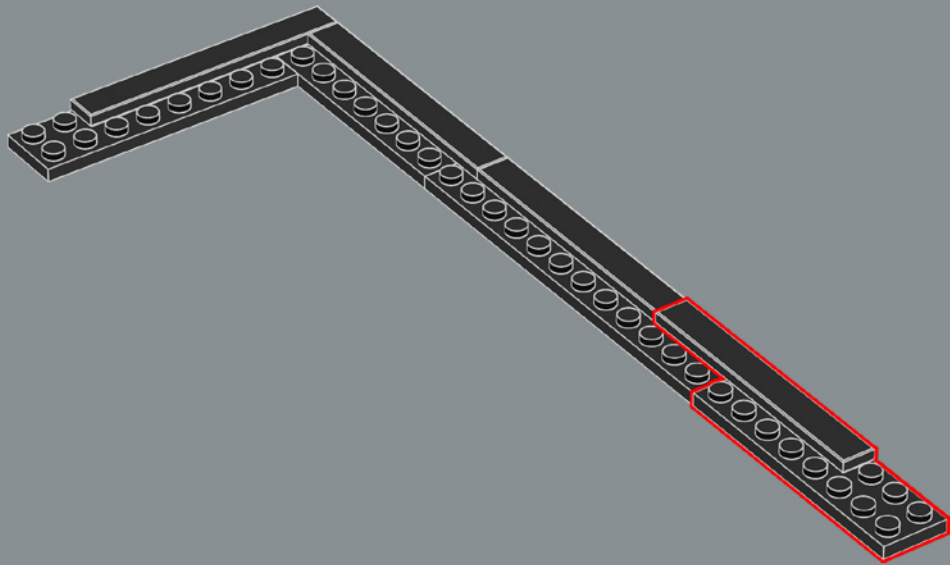

5

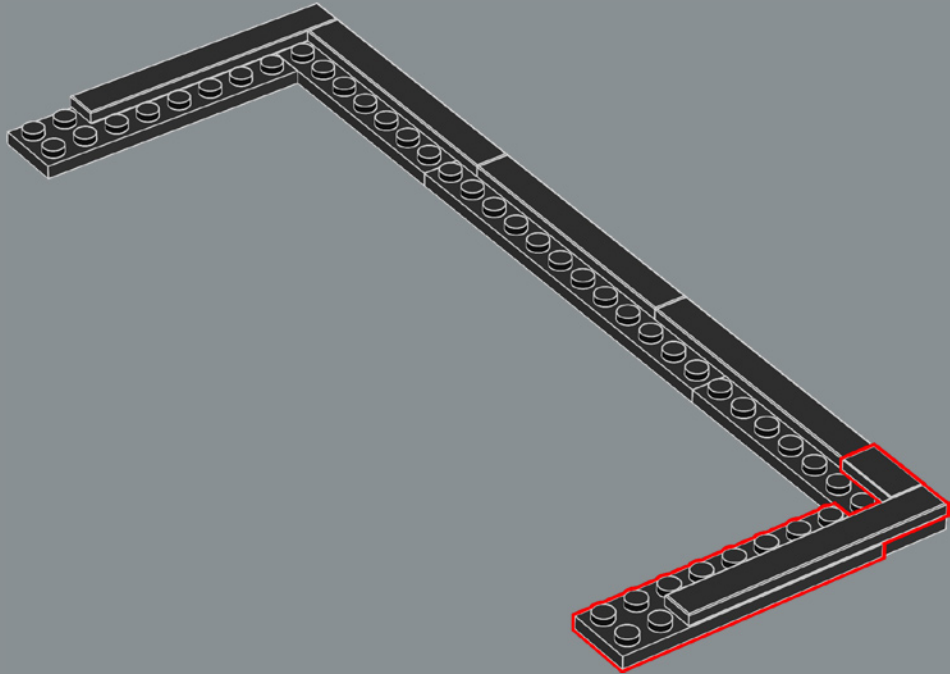

8

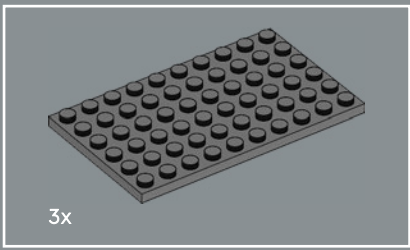

6

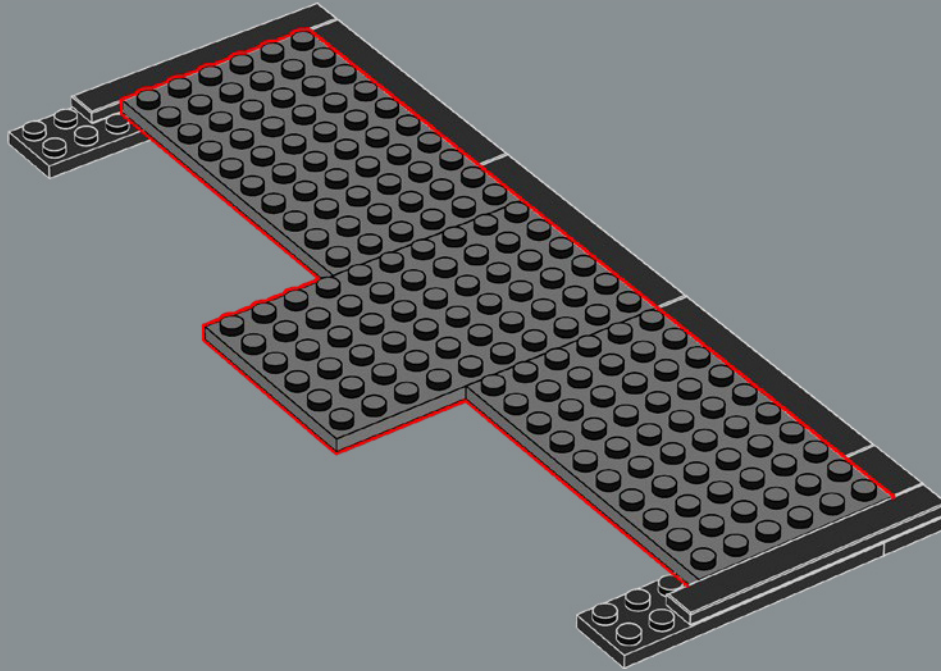

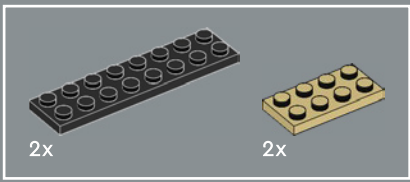

7

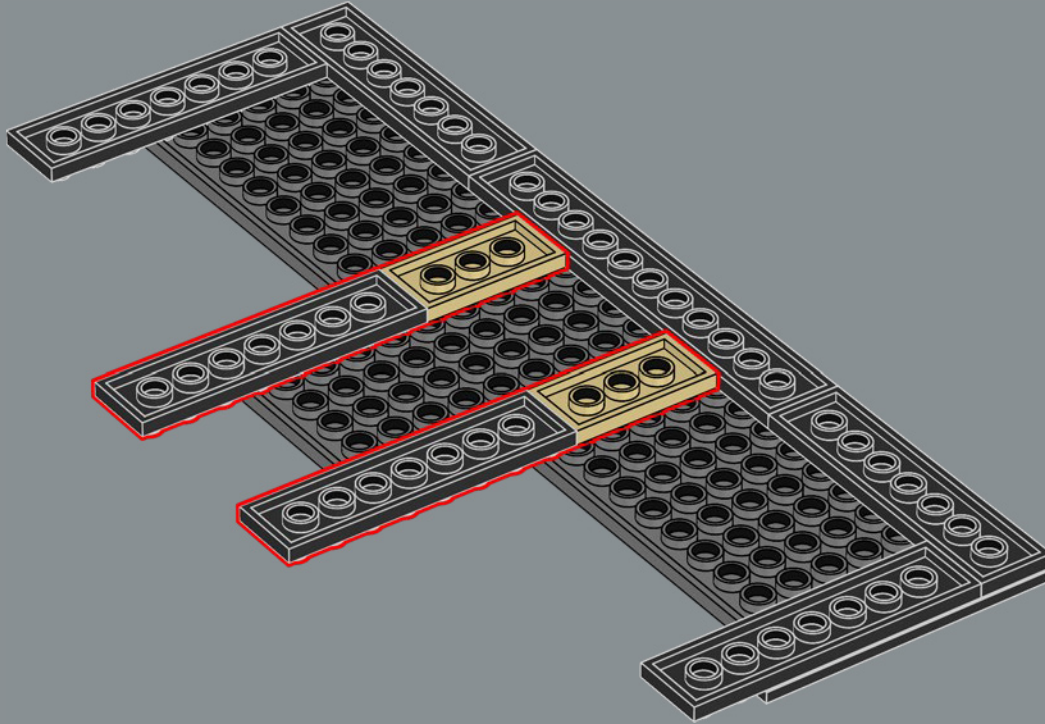

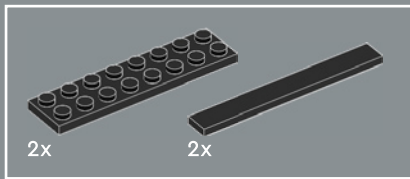

8

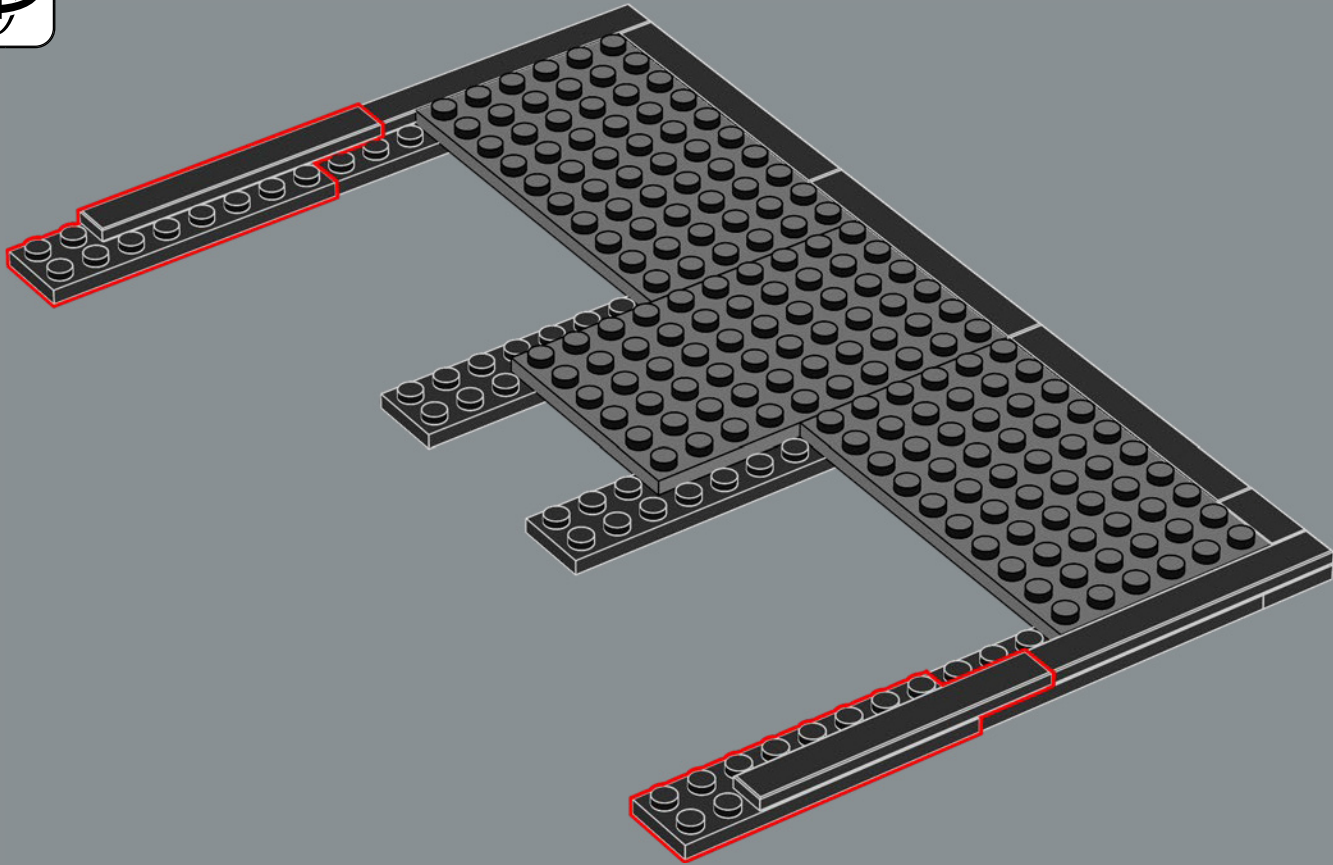

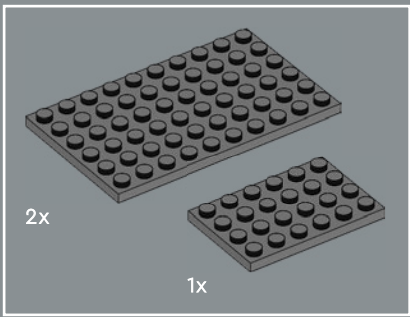

9

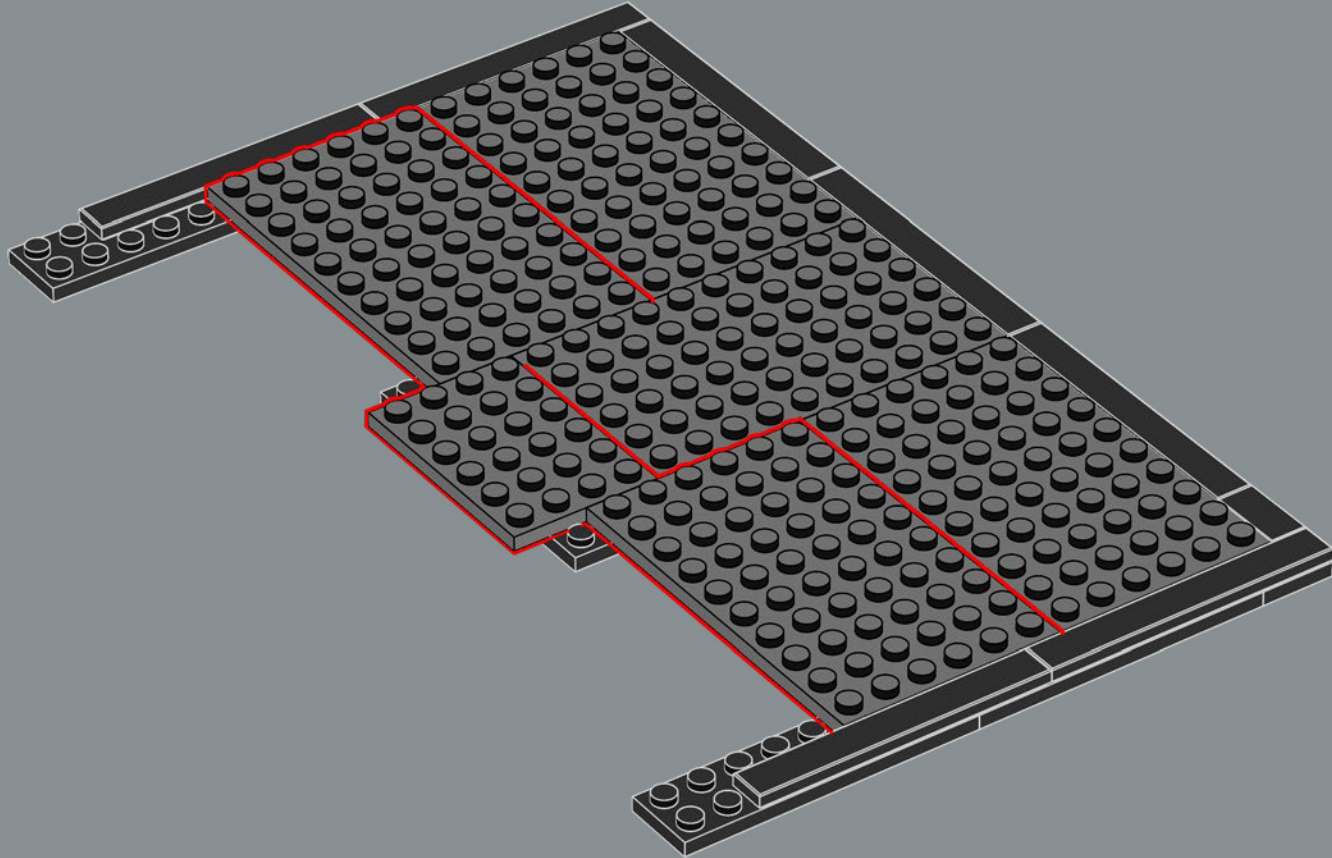

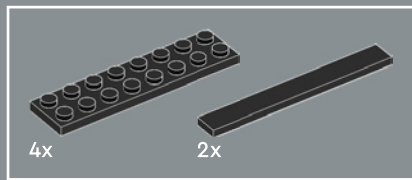

10

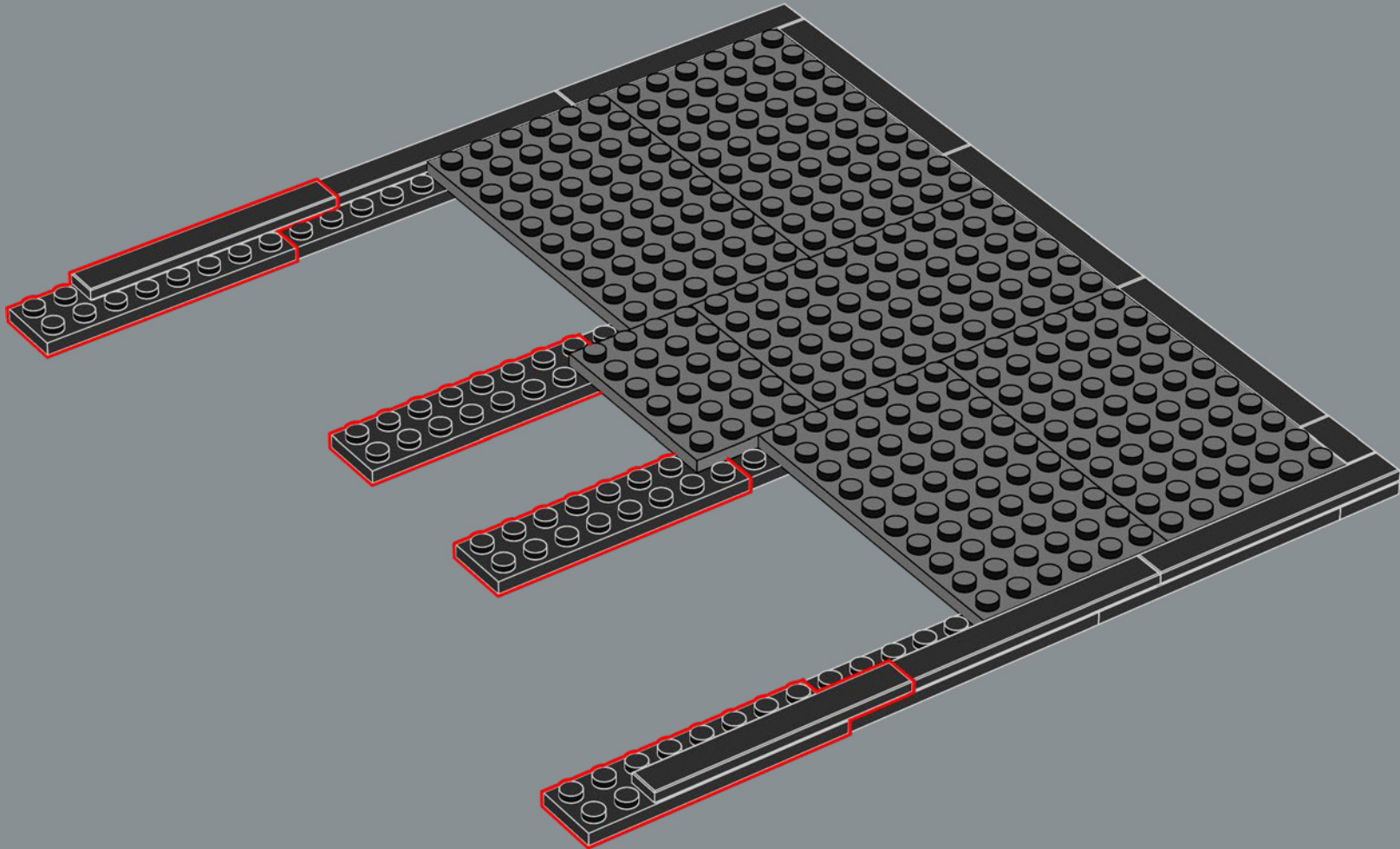

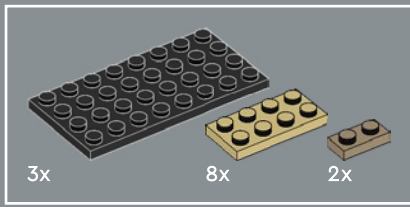

12

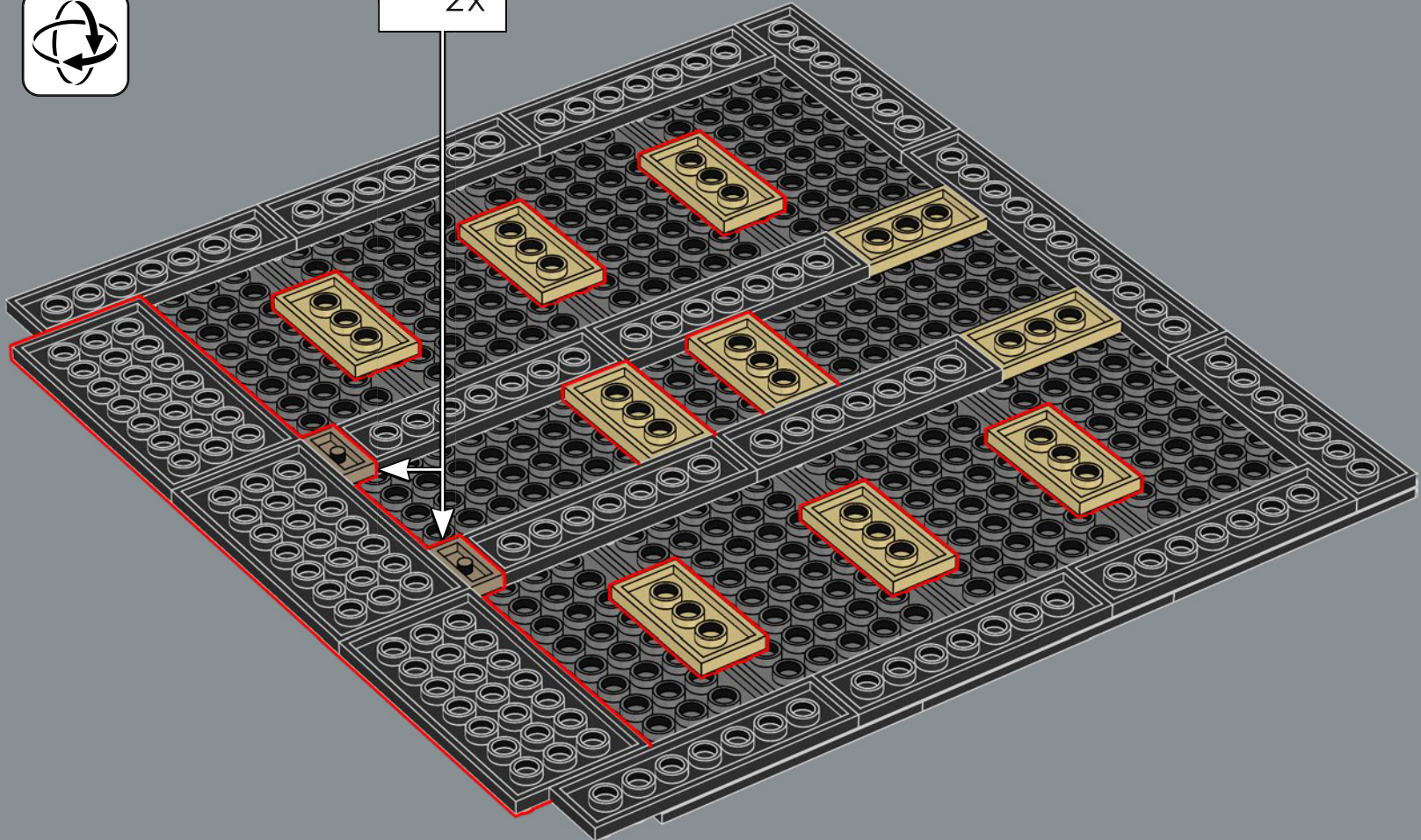
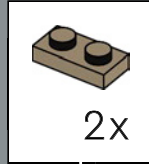

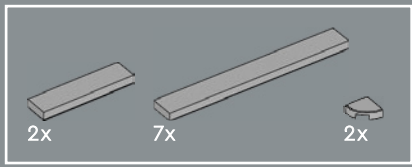

13

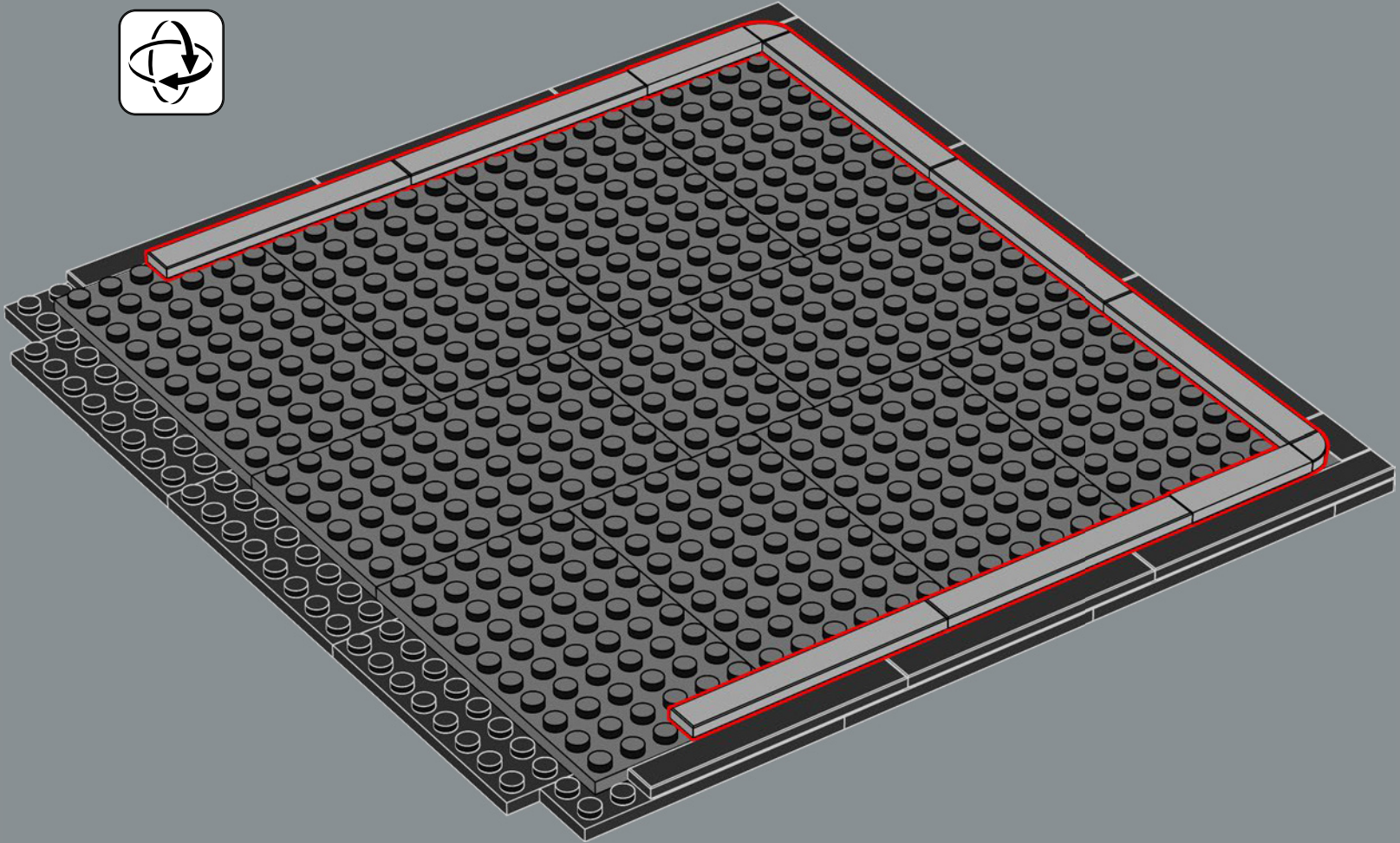

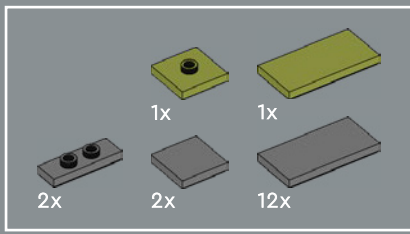

14

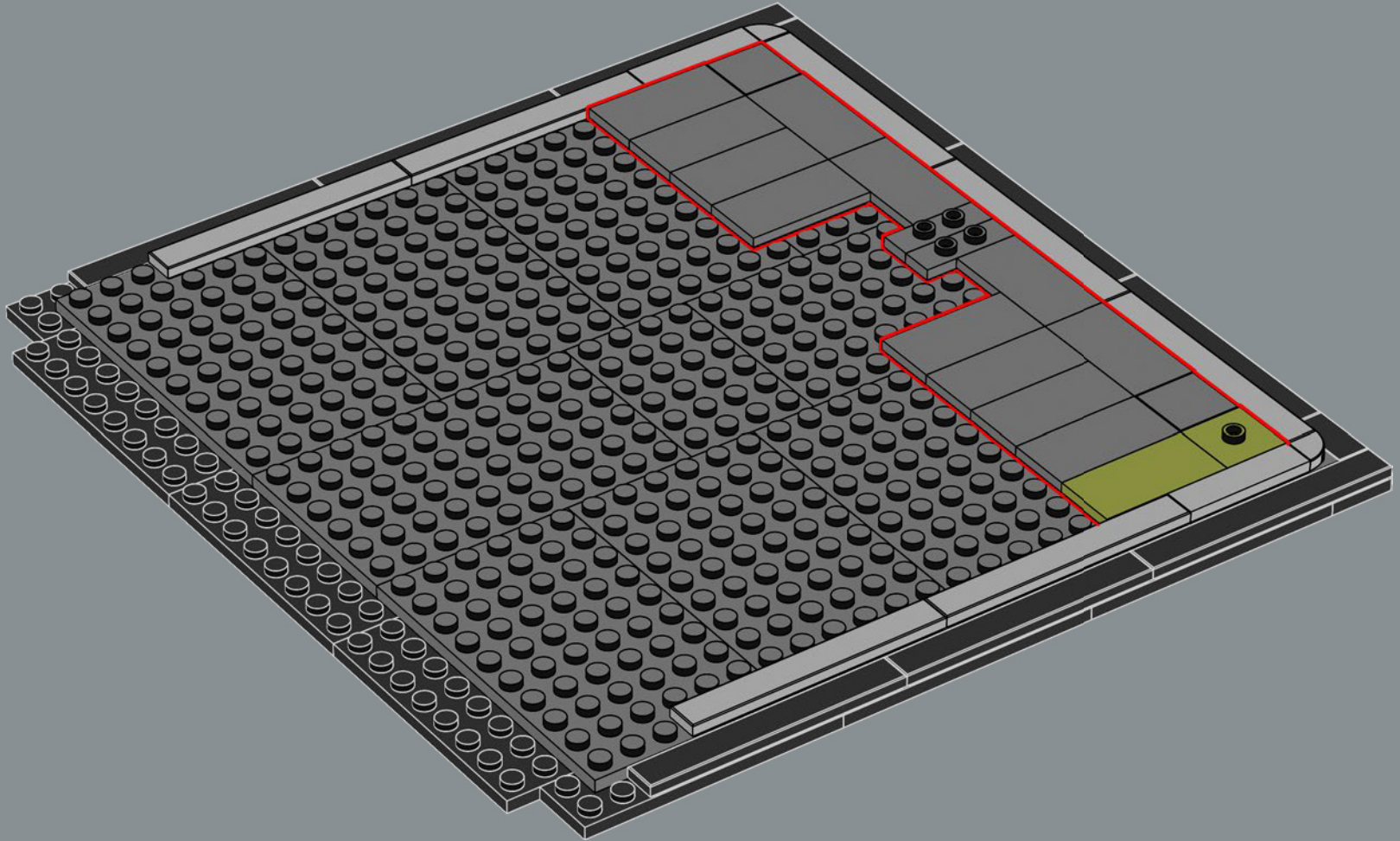

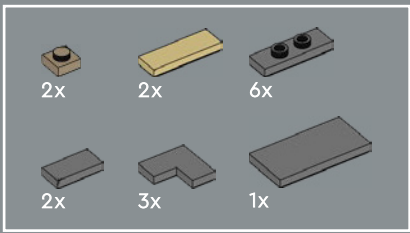

1163: Los planos de la Catedral de Notre Dame están listos. Comienza la construcción y el papa Alejandro III supervisa la colocación de la primera piedra.

15

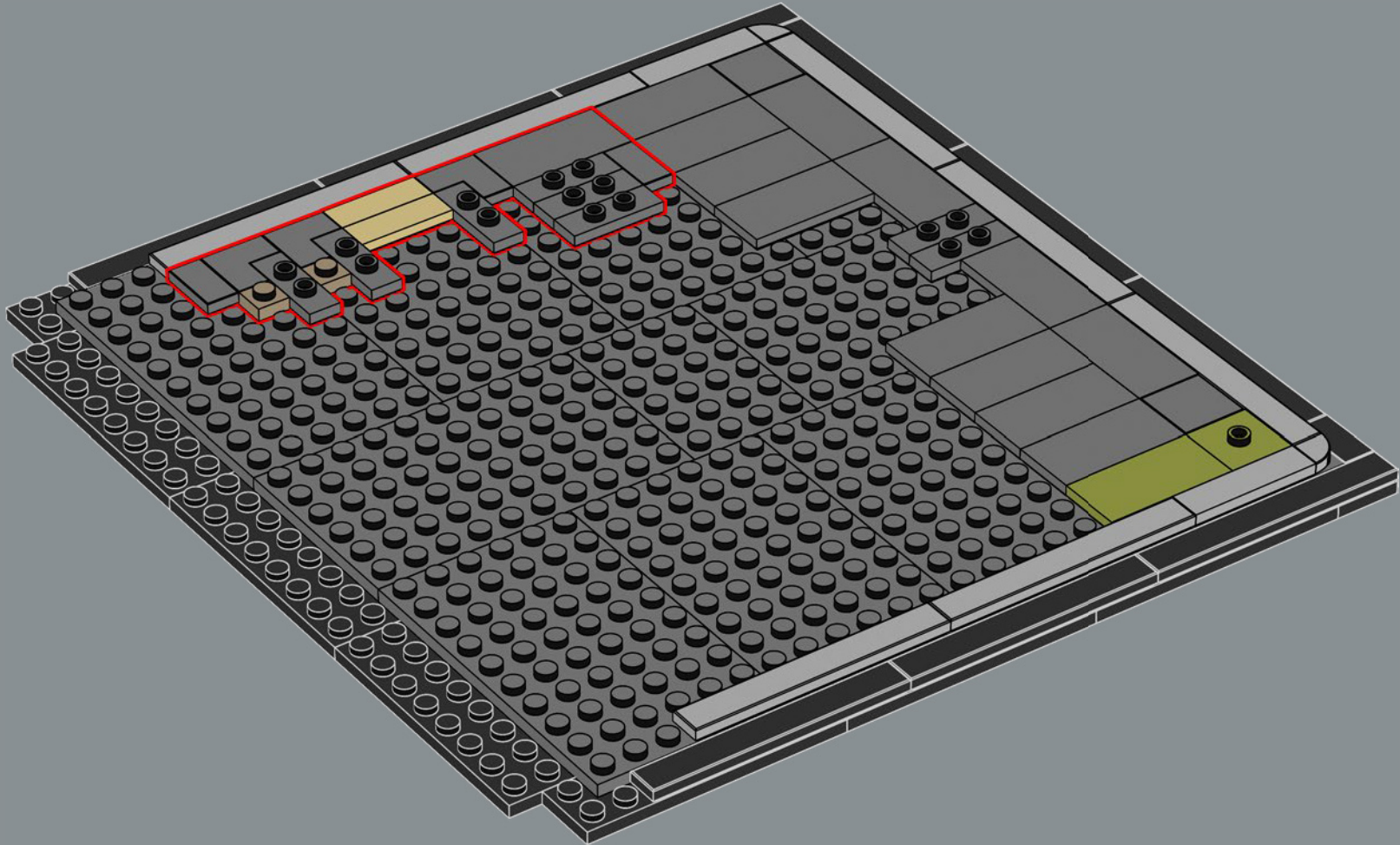

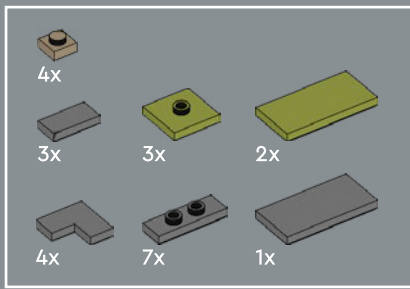

16

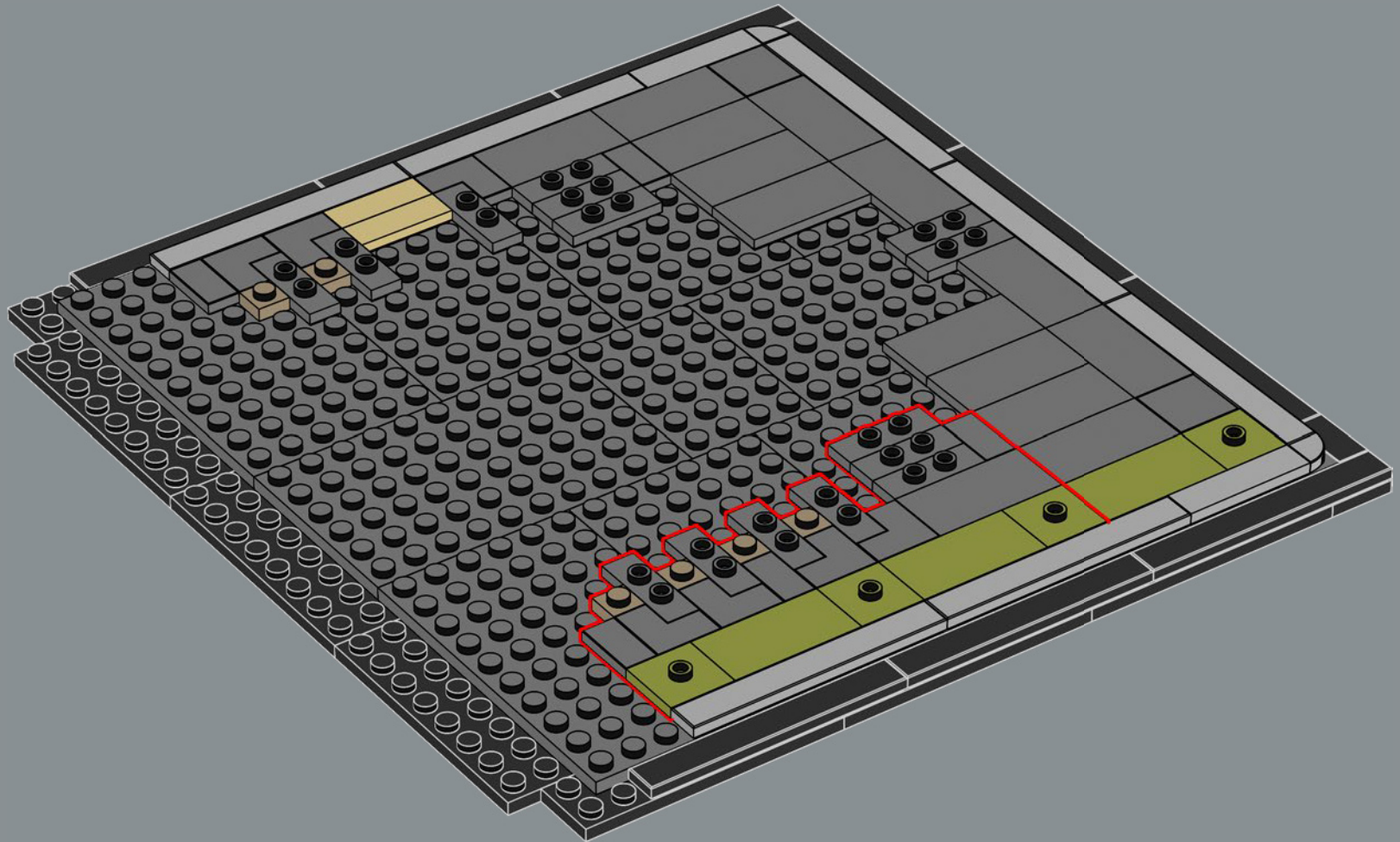

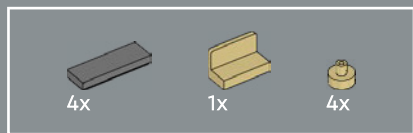

17

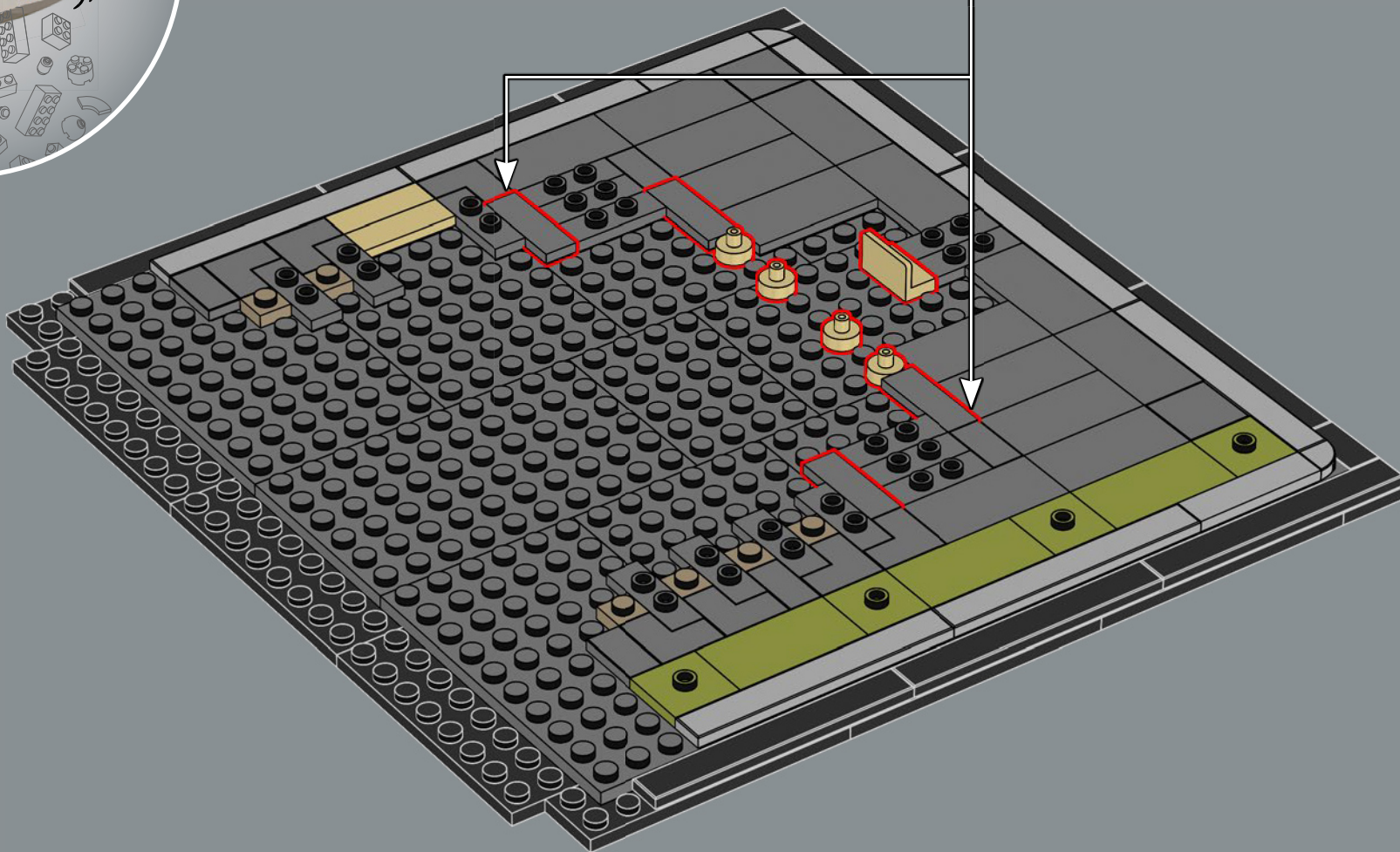
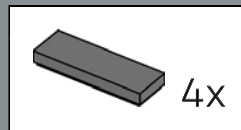



18

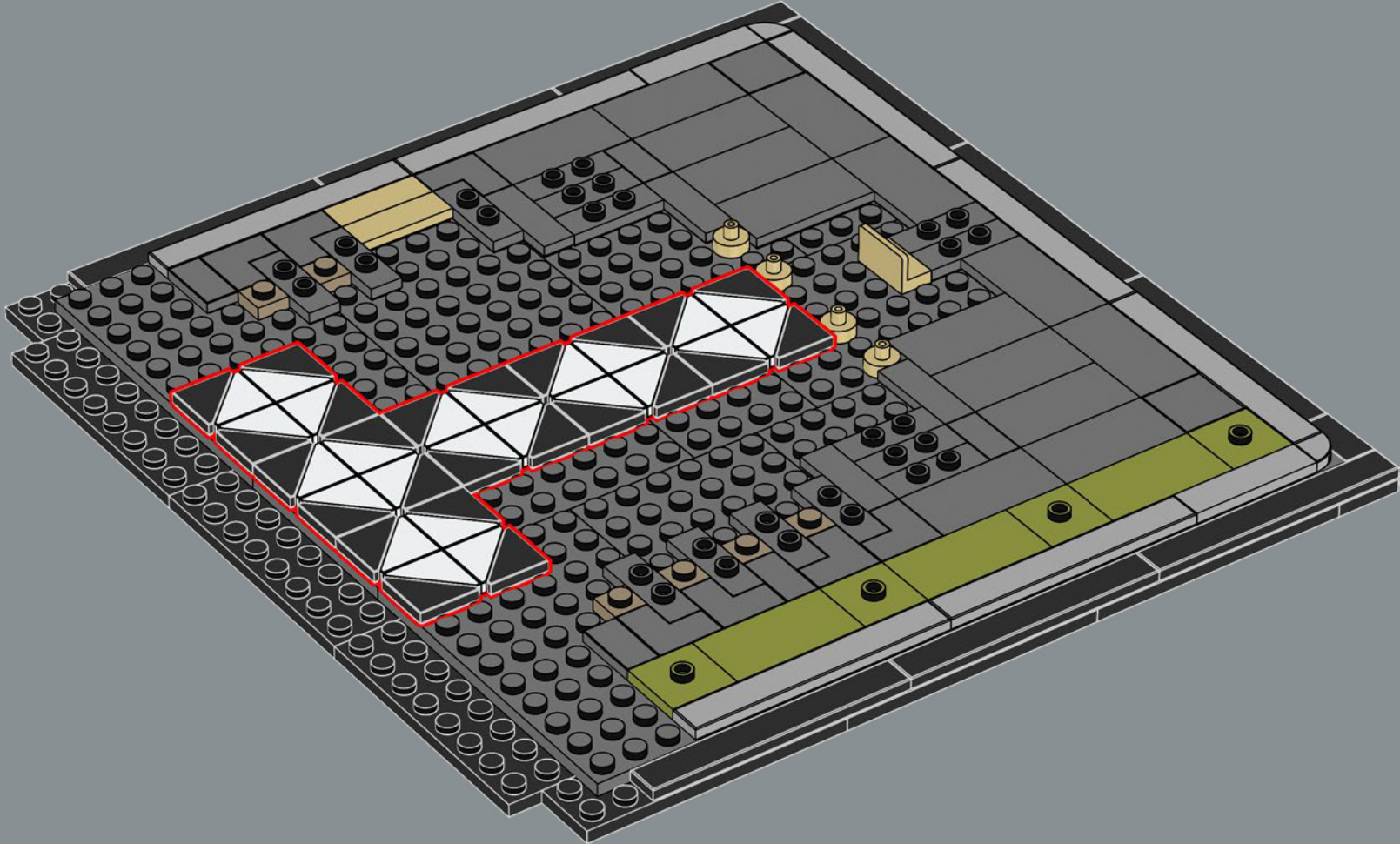



20x

19

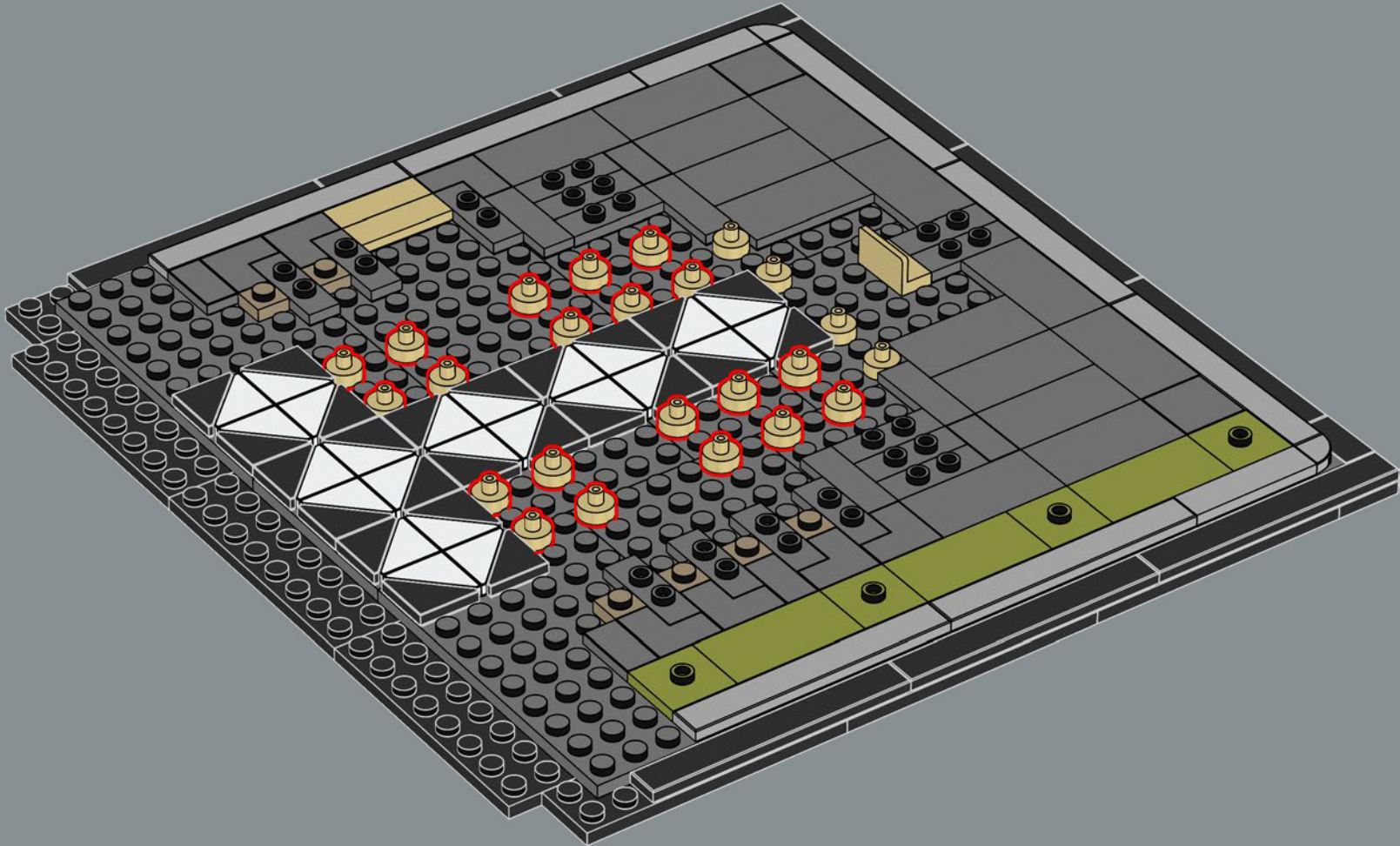

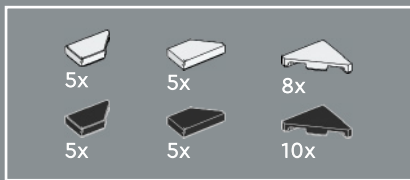

20

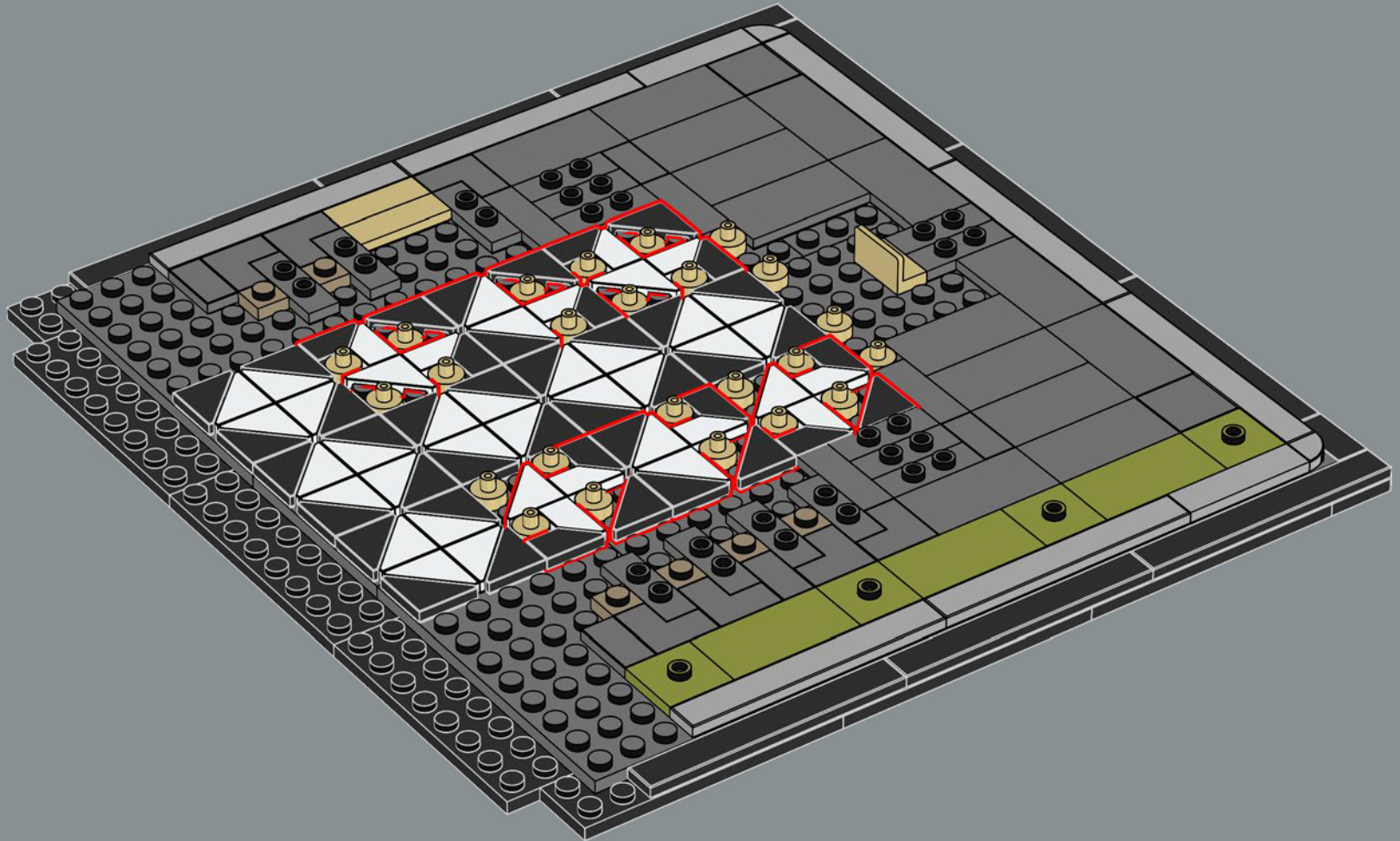

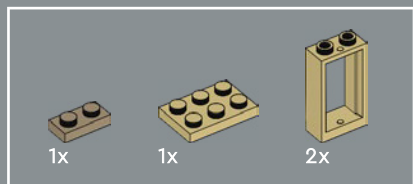

21

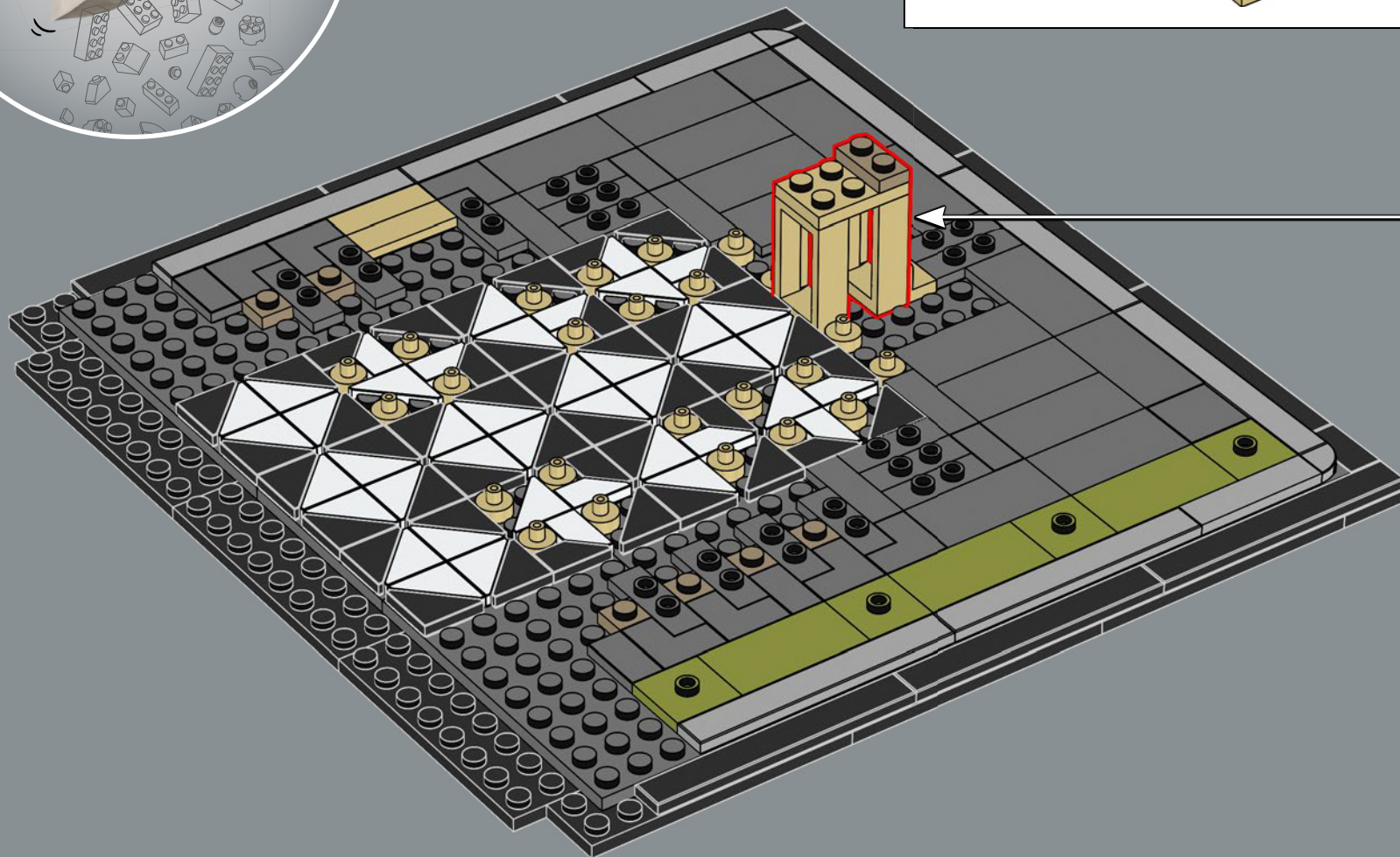
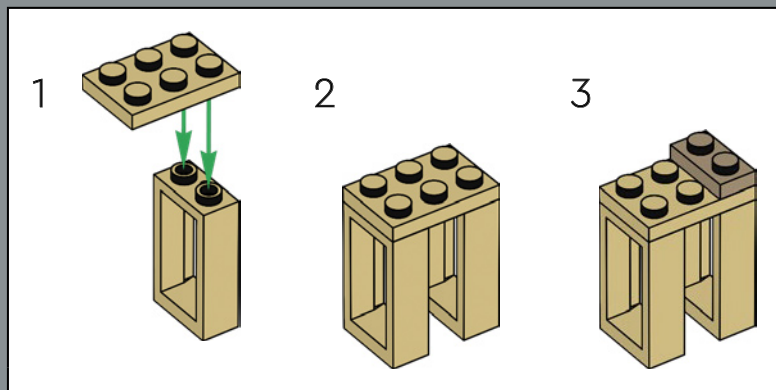

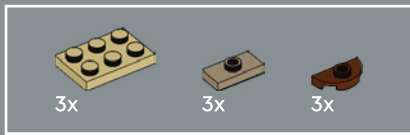

22

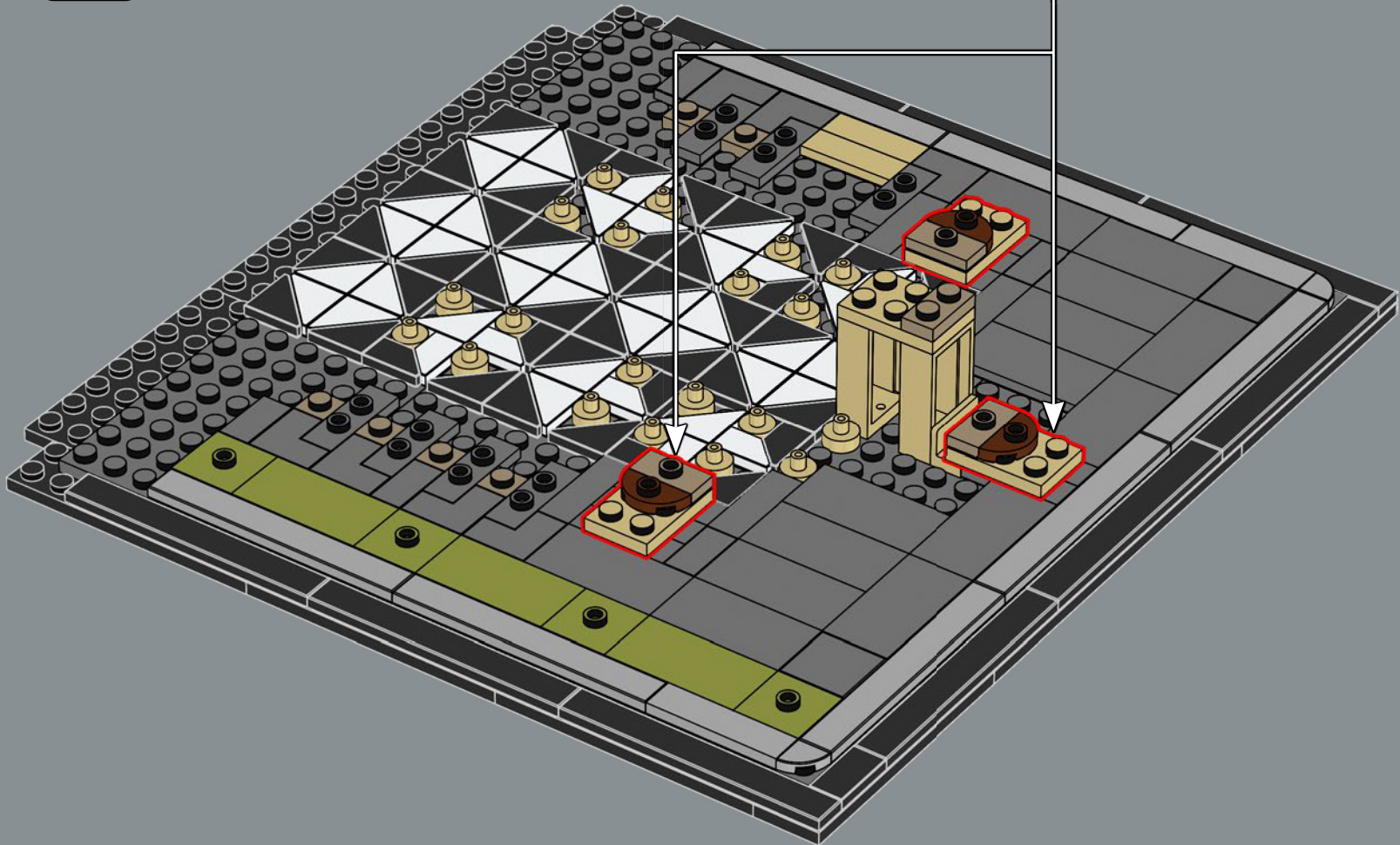
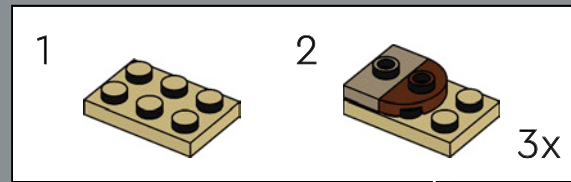

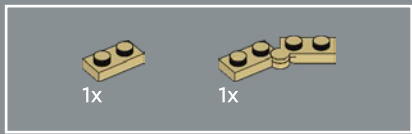

23

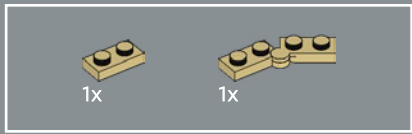
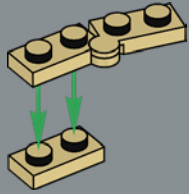

24

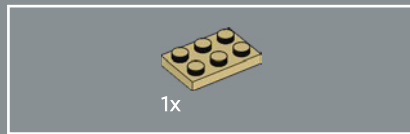
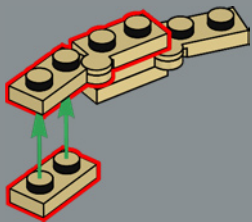

25

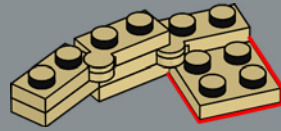

26

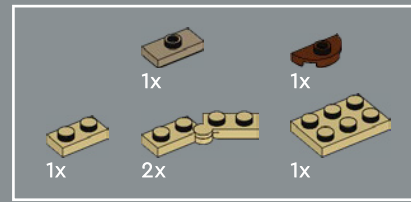
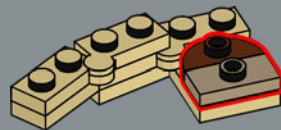

27

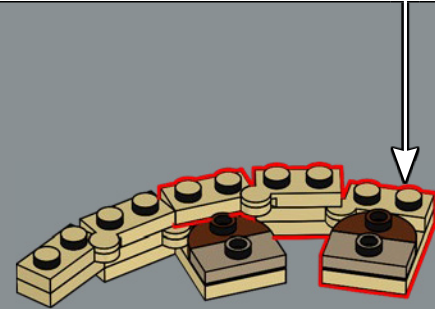
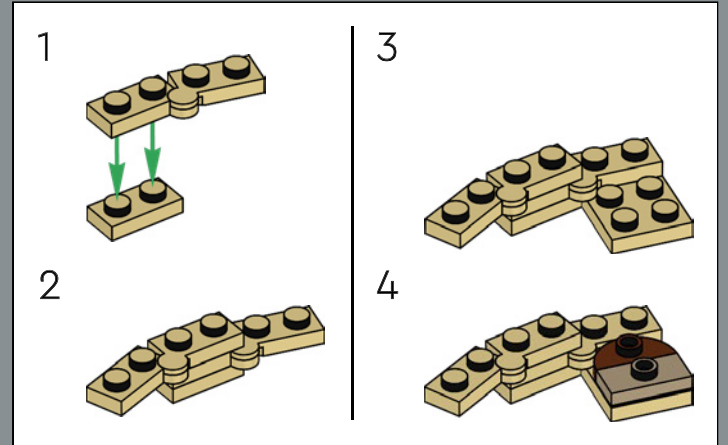

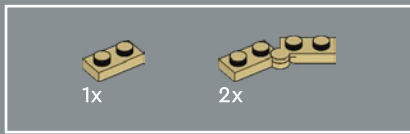

28

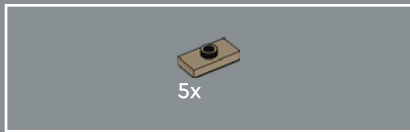
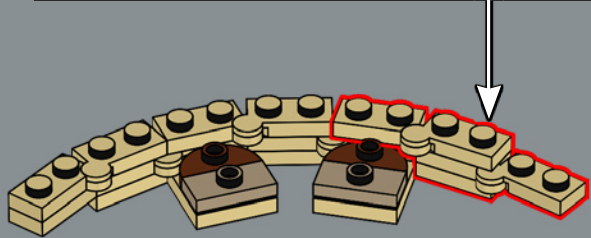
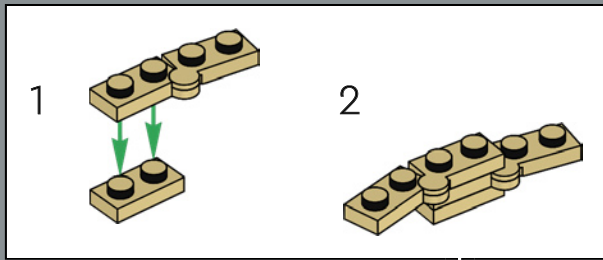

29

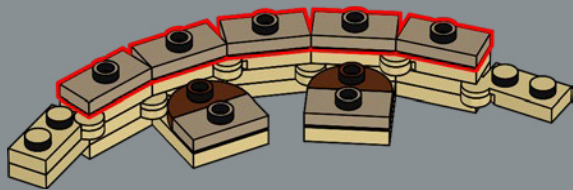

30

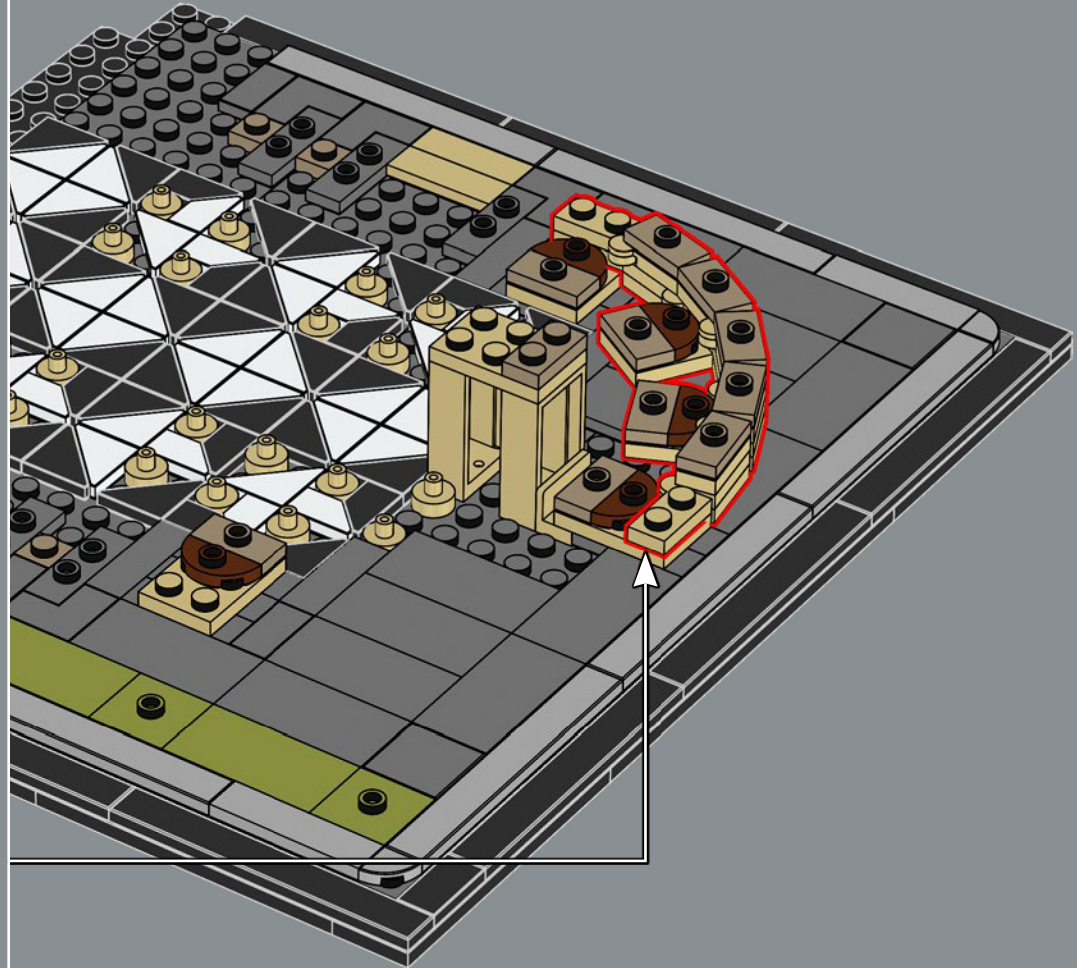

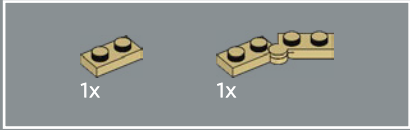
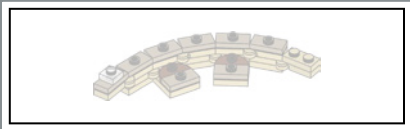

31

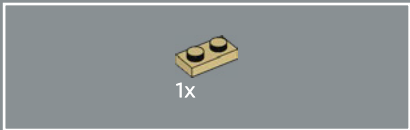
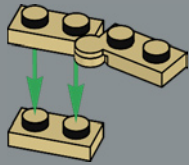

32

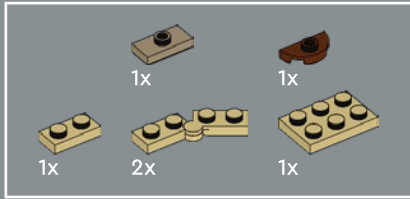

33

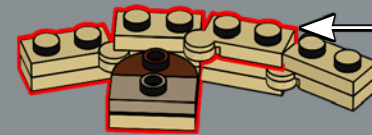
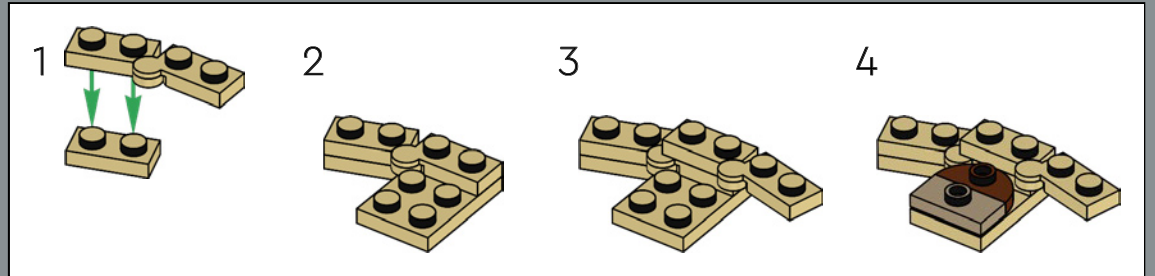

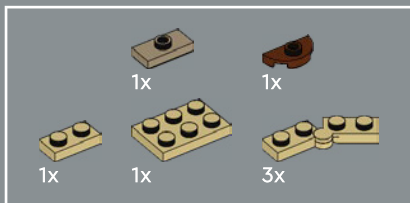

34

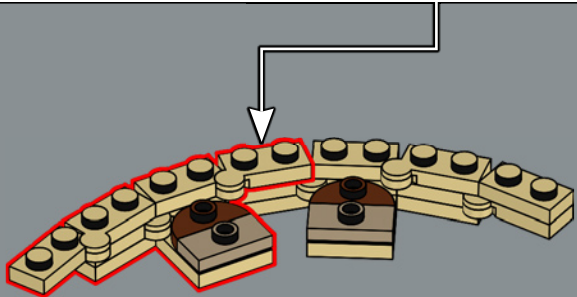
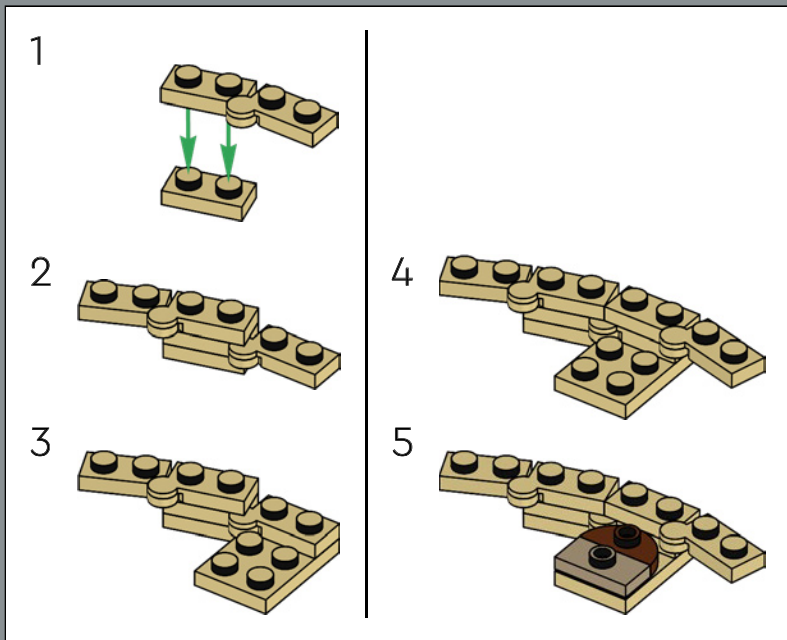

35

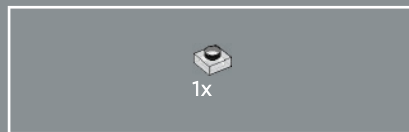
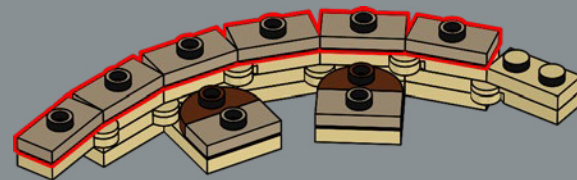

36

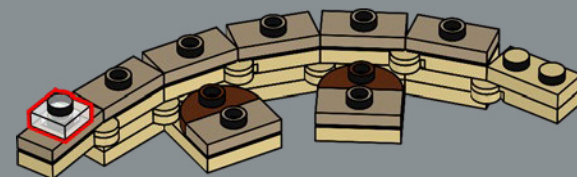

1163: Algunos elementos de la planta se determinan mediante una serie de círculos trazados con la ayuda de cuerdas de diferentes longitudes. Estas cuerdas estaban atadas a una estaca clavada en el centro de la catedral.

37

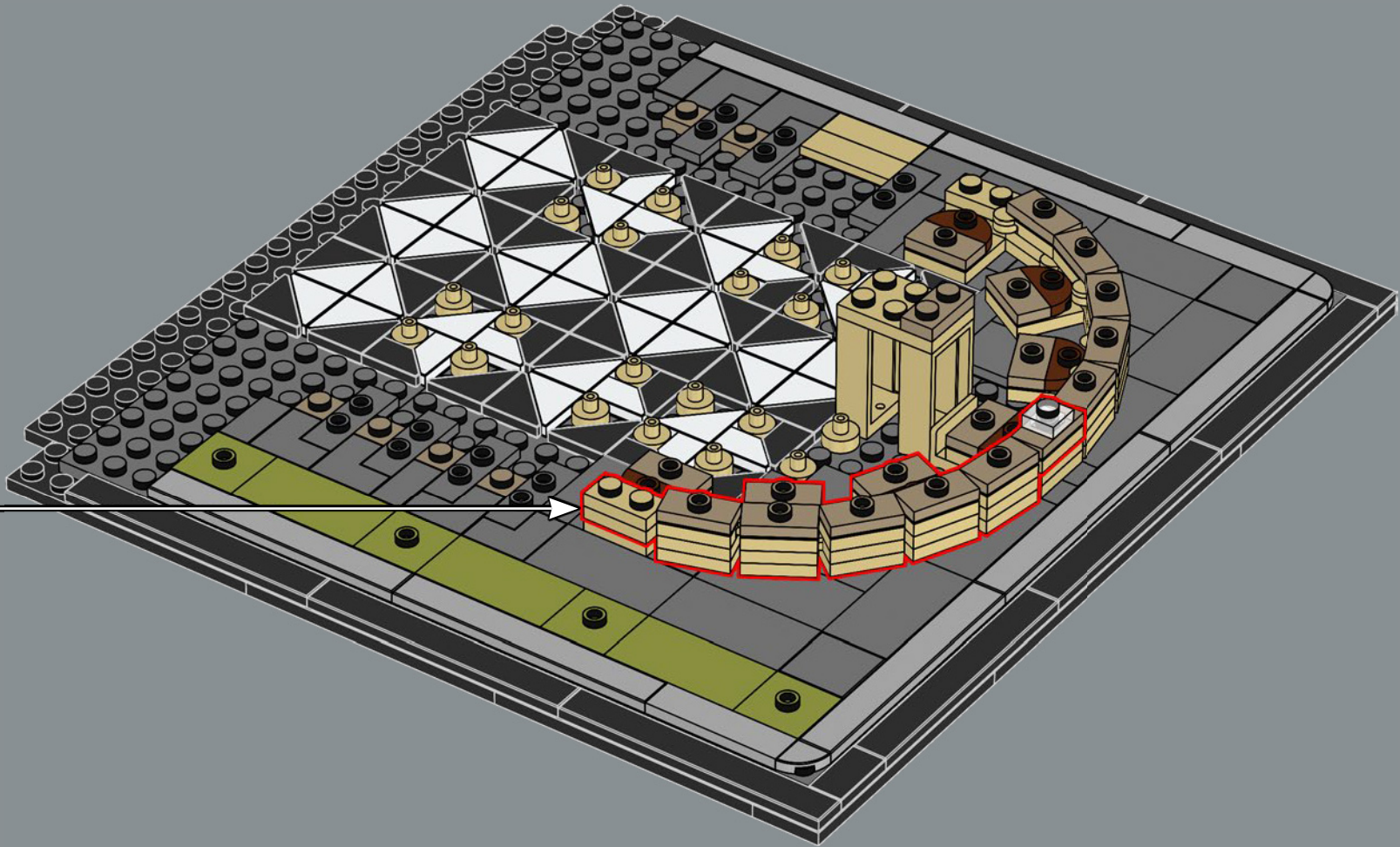

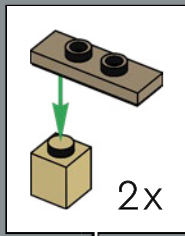
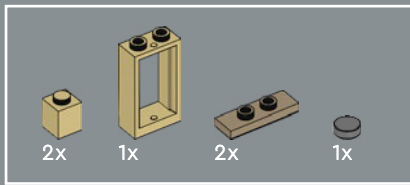

38

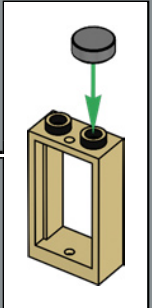
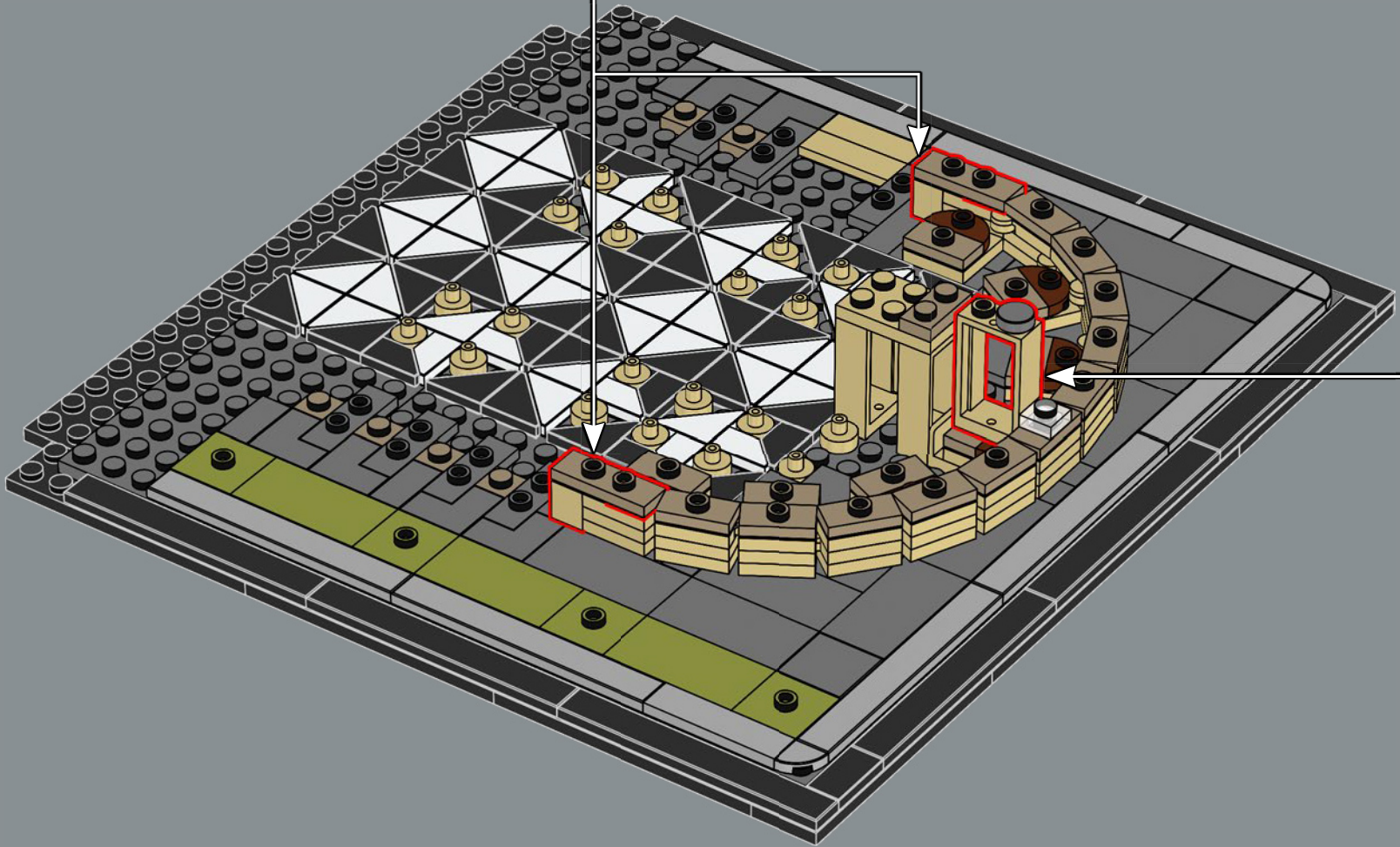

1163-1170: Se construye el ábside con pilares en disposición semicircular.

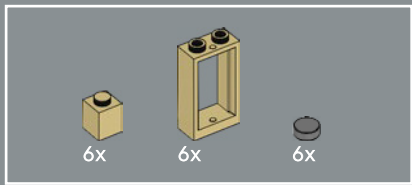

39

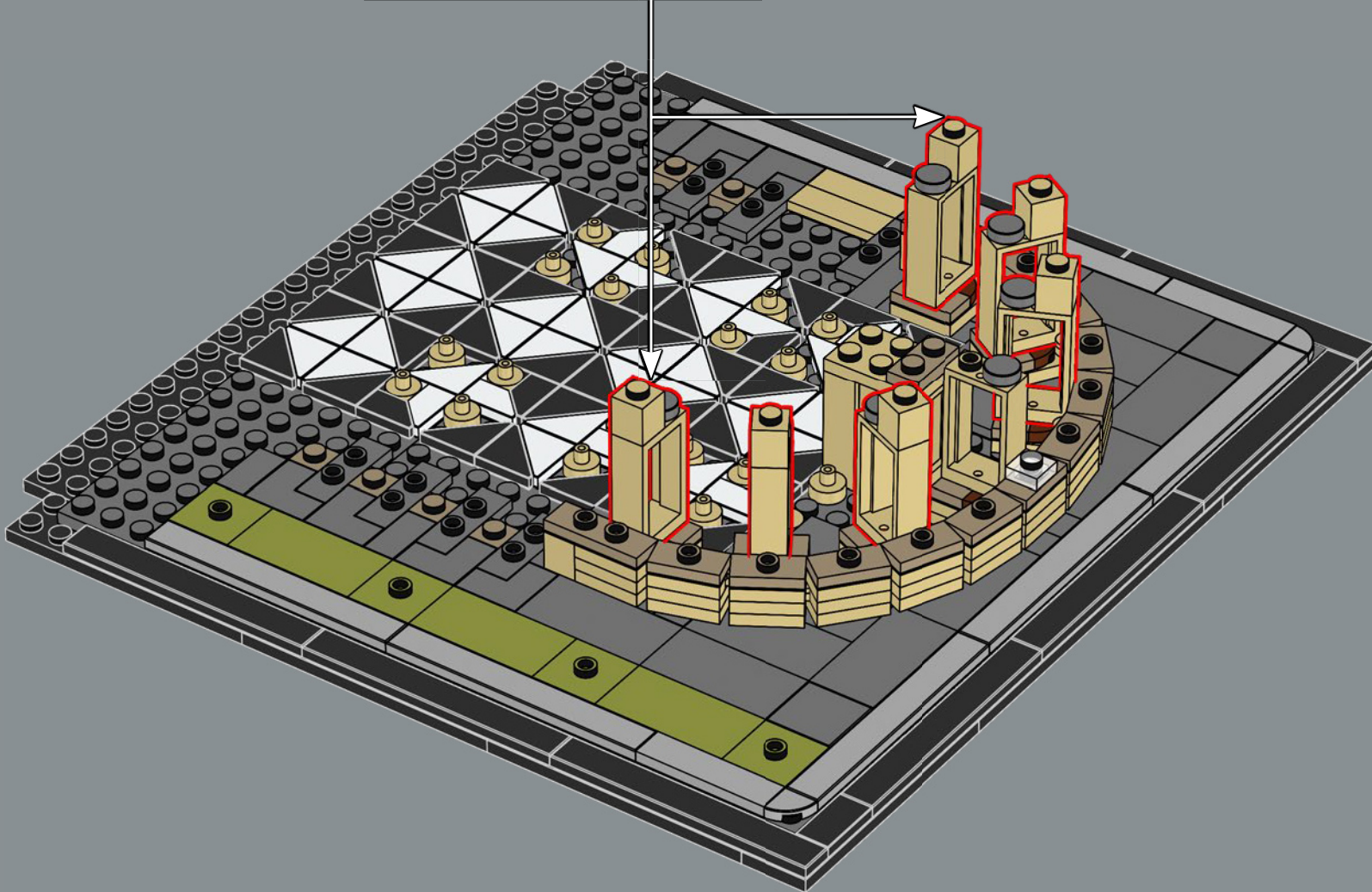
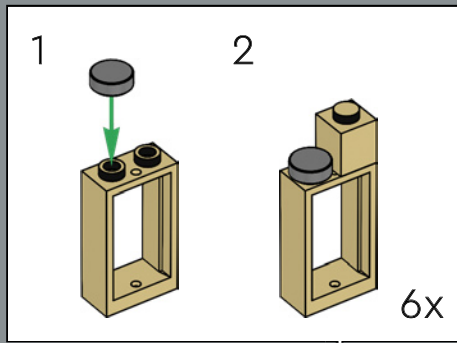



40

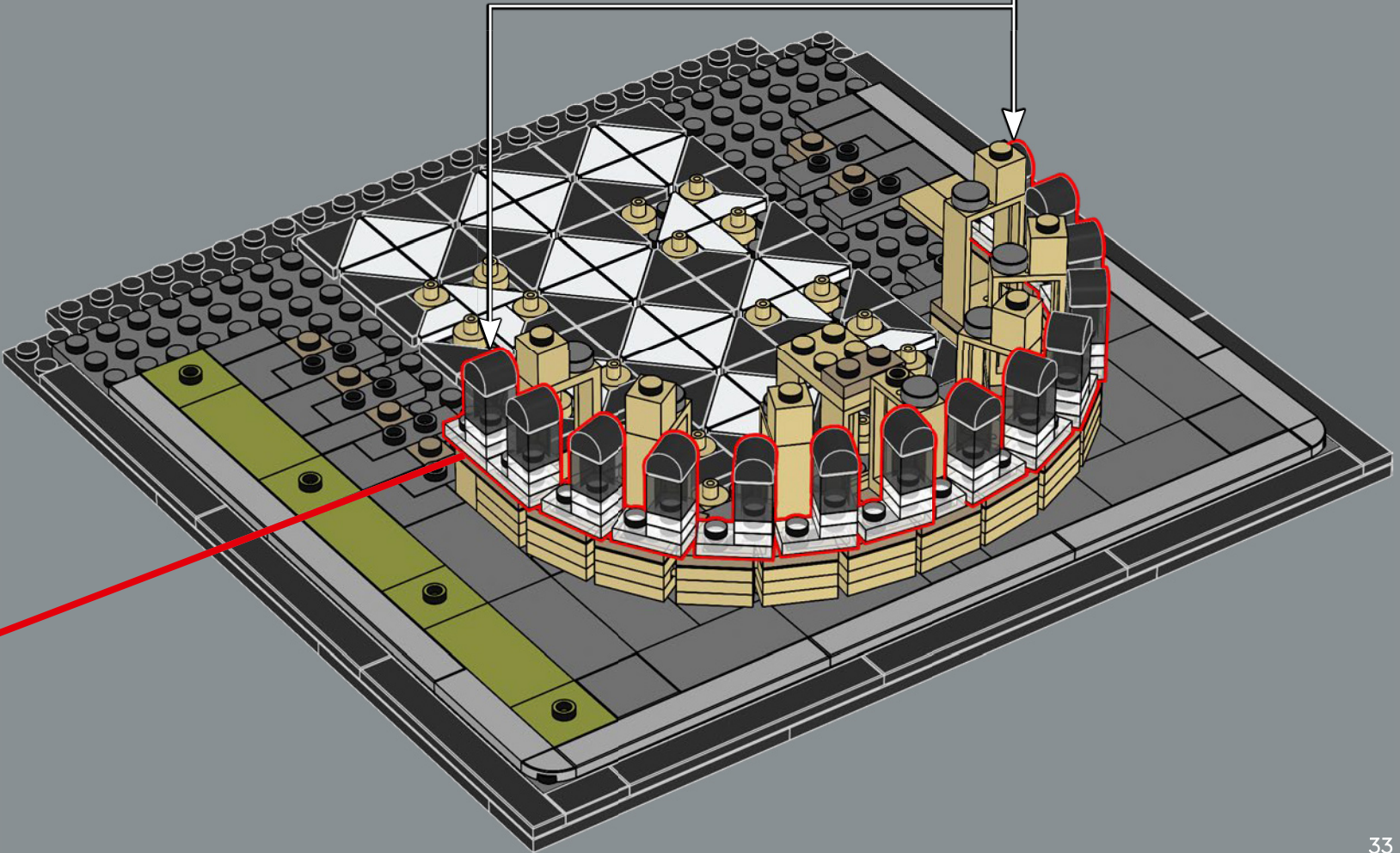
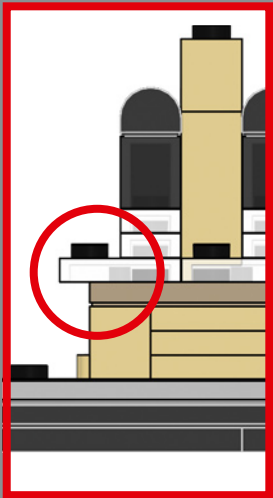
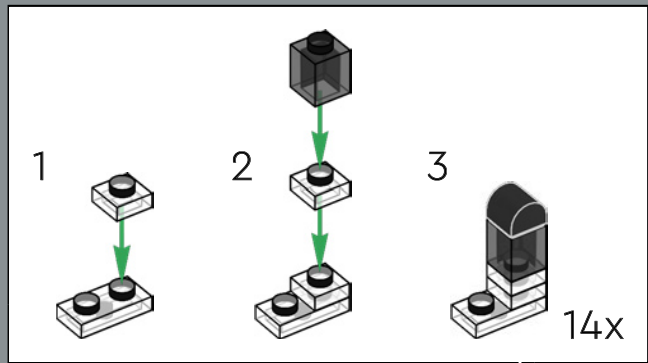

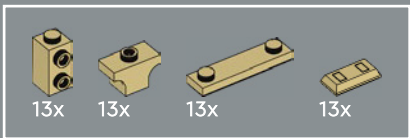

41

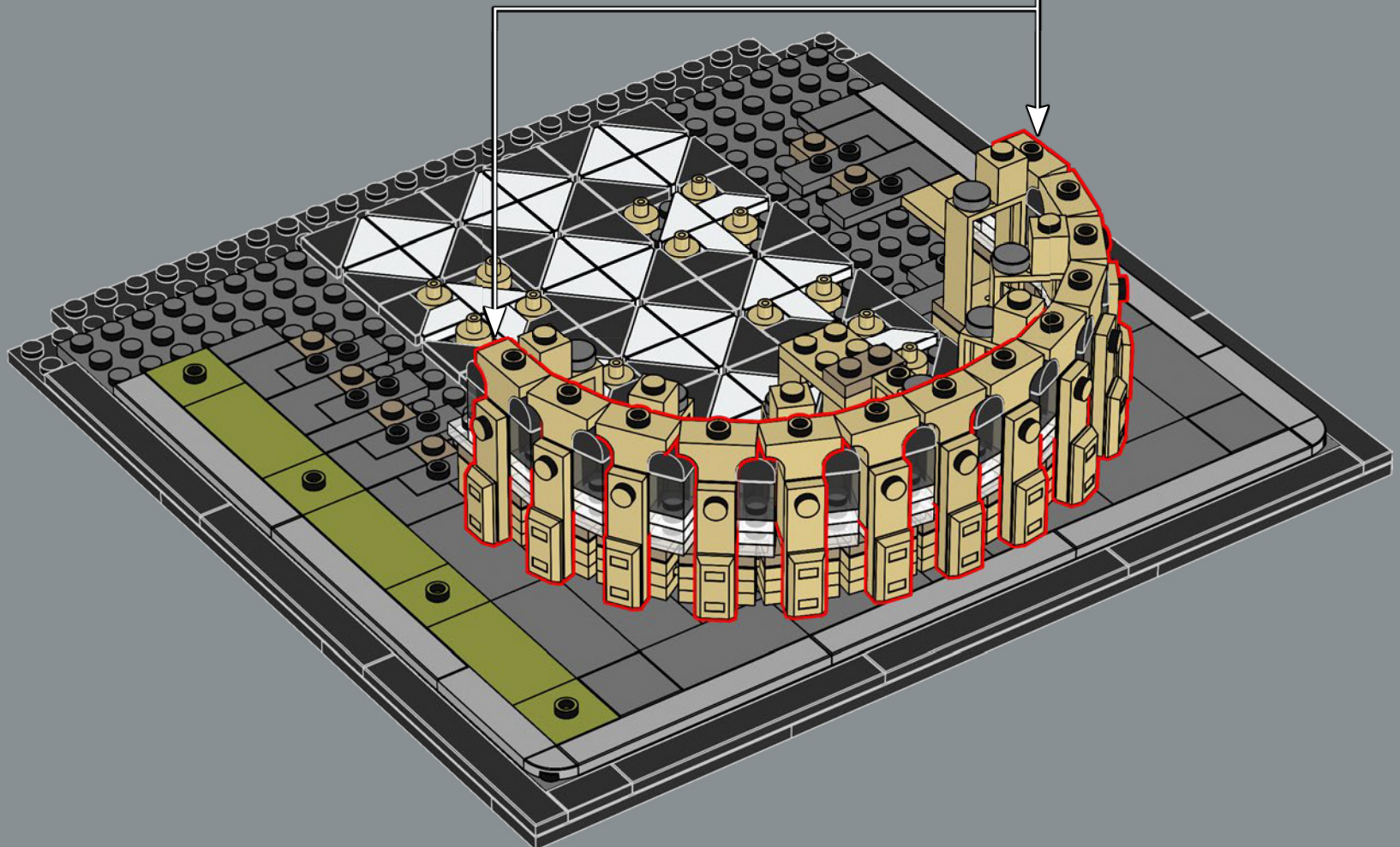
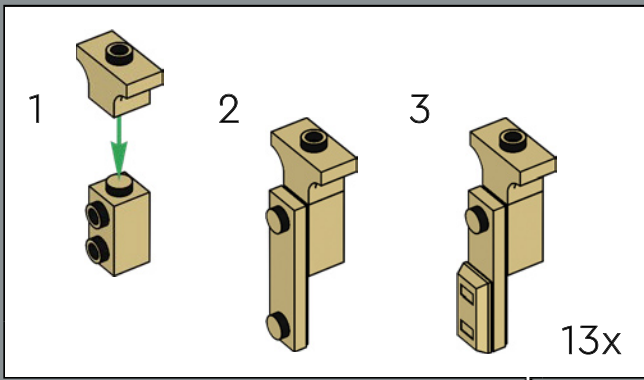

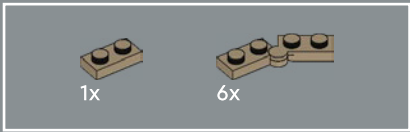

42

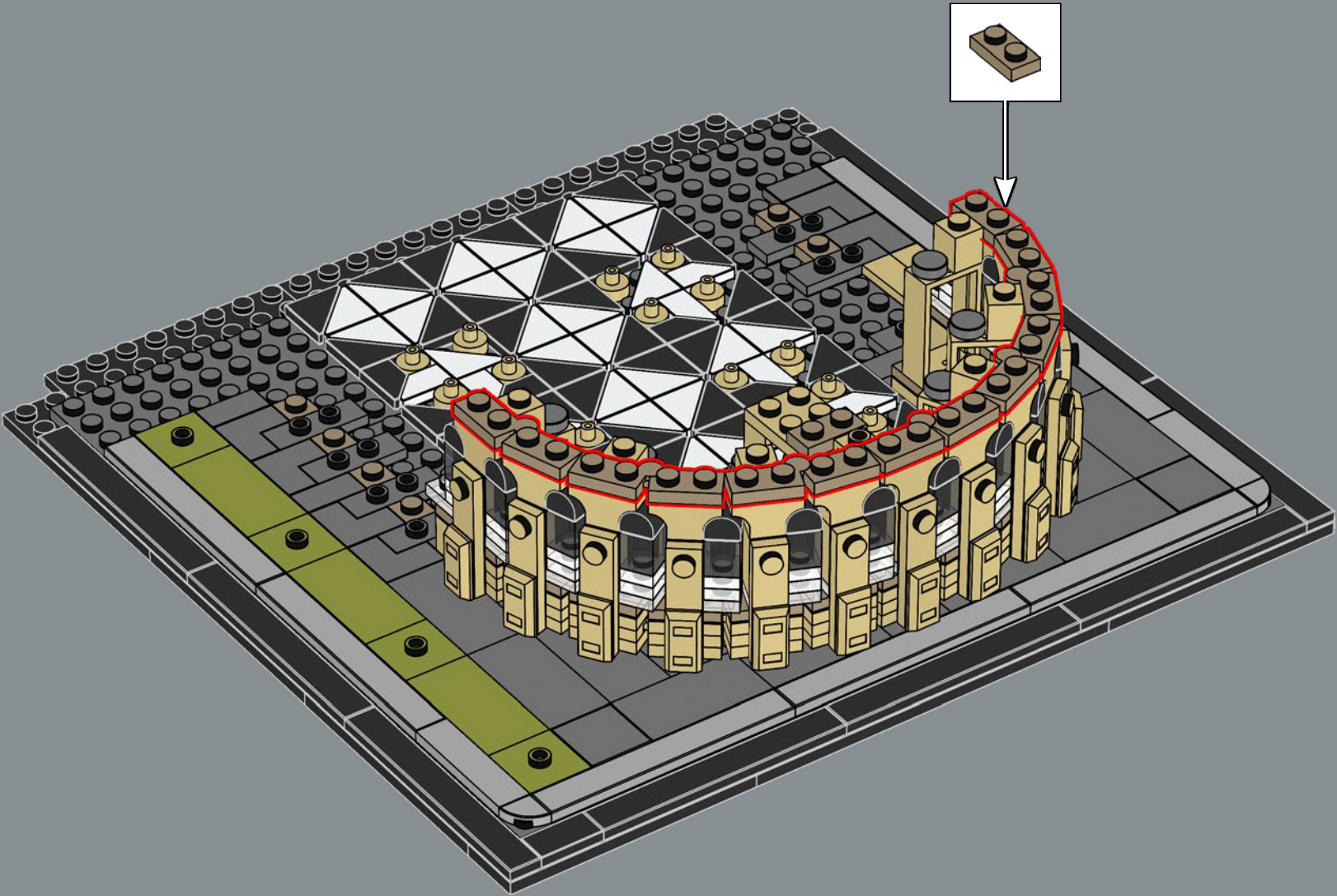

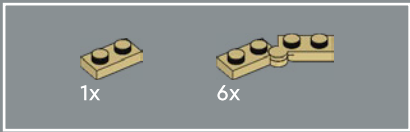

43

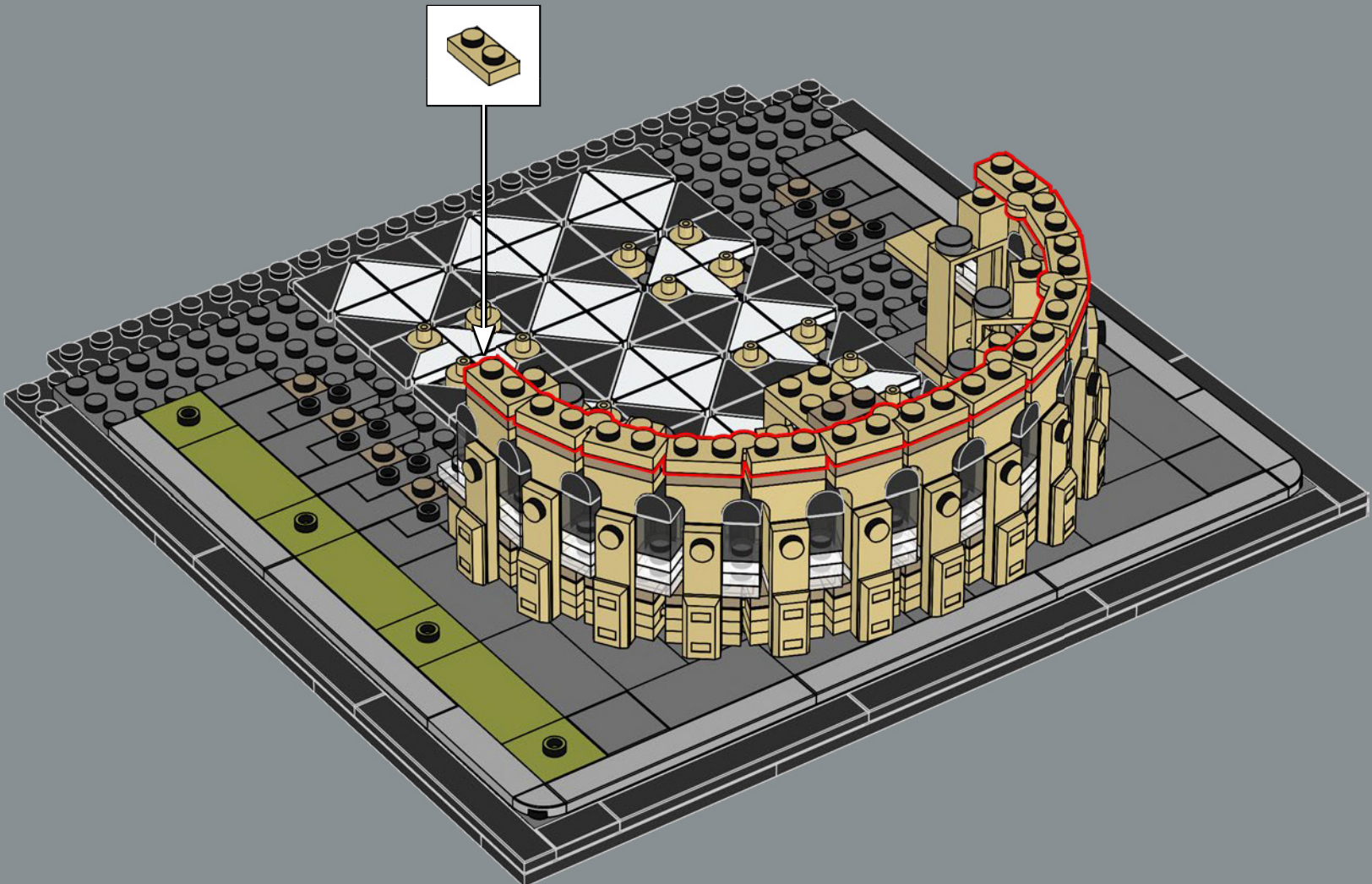

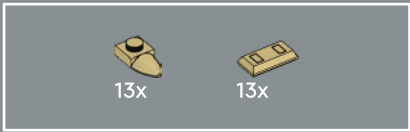

44

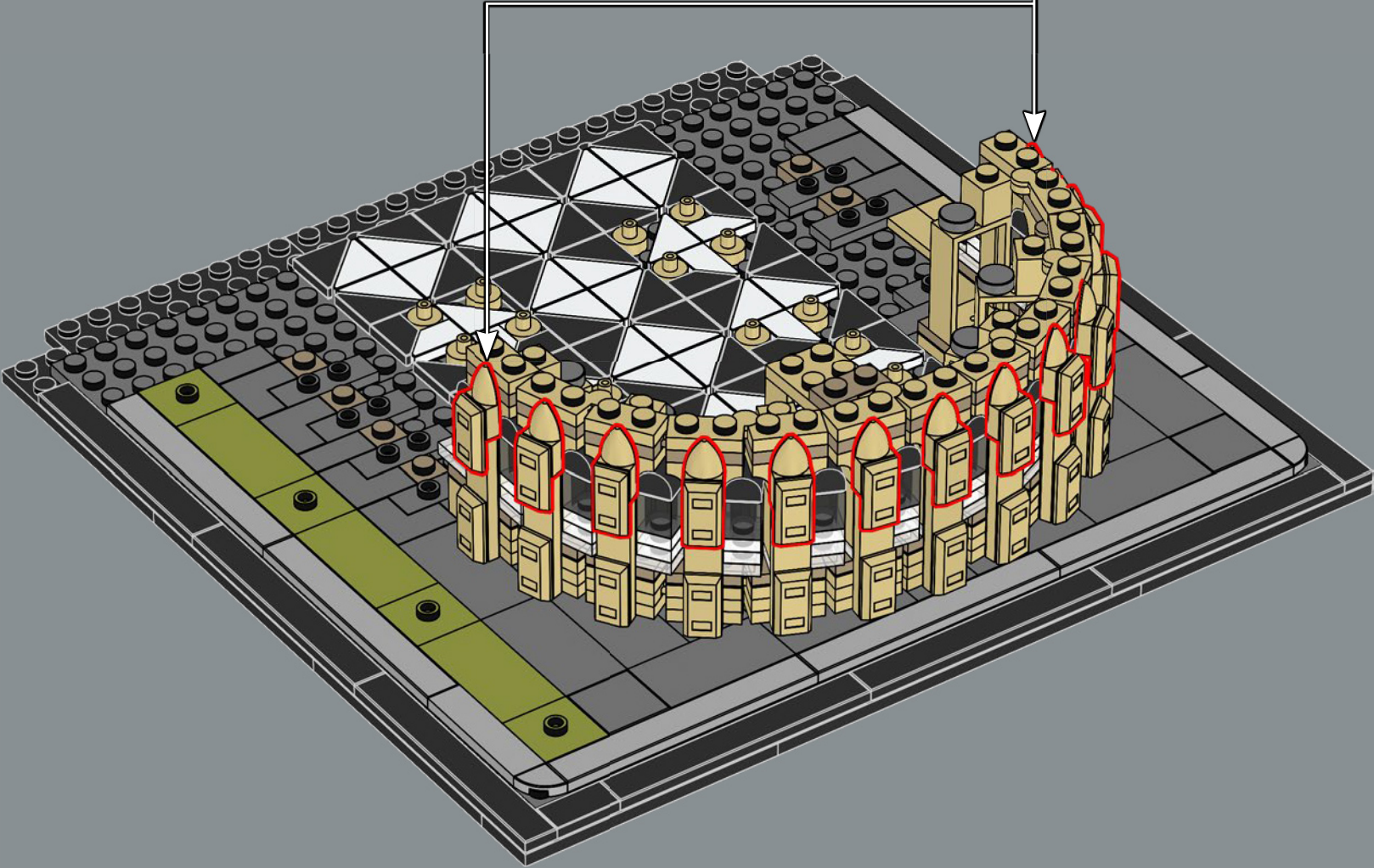
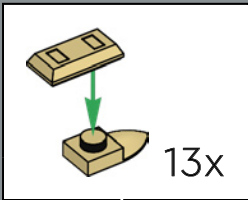

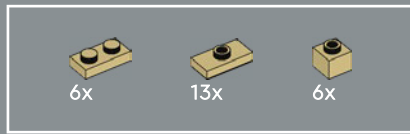

45

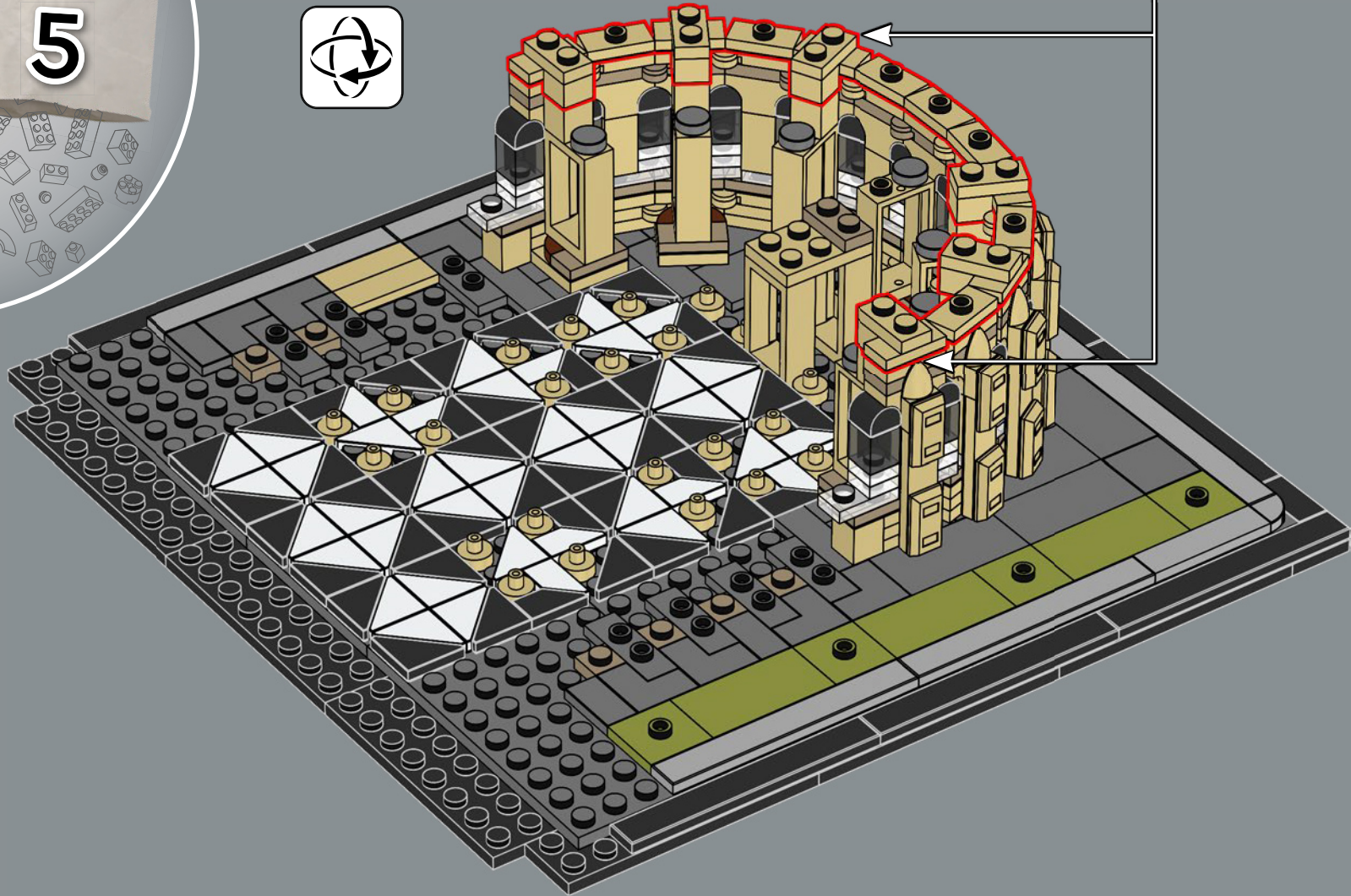
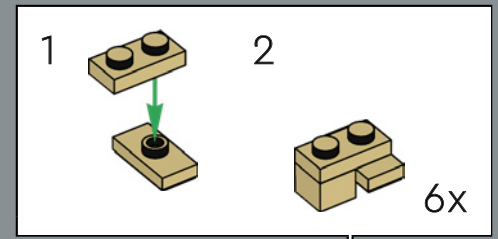



46

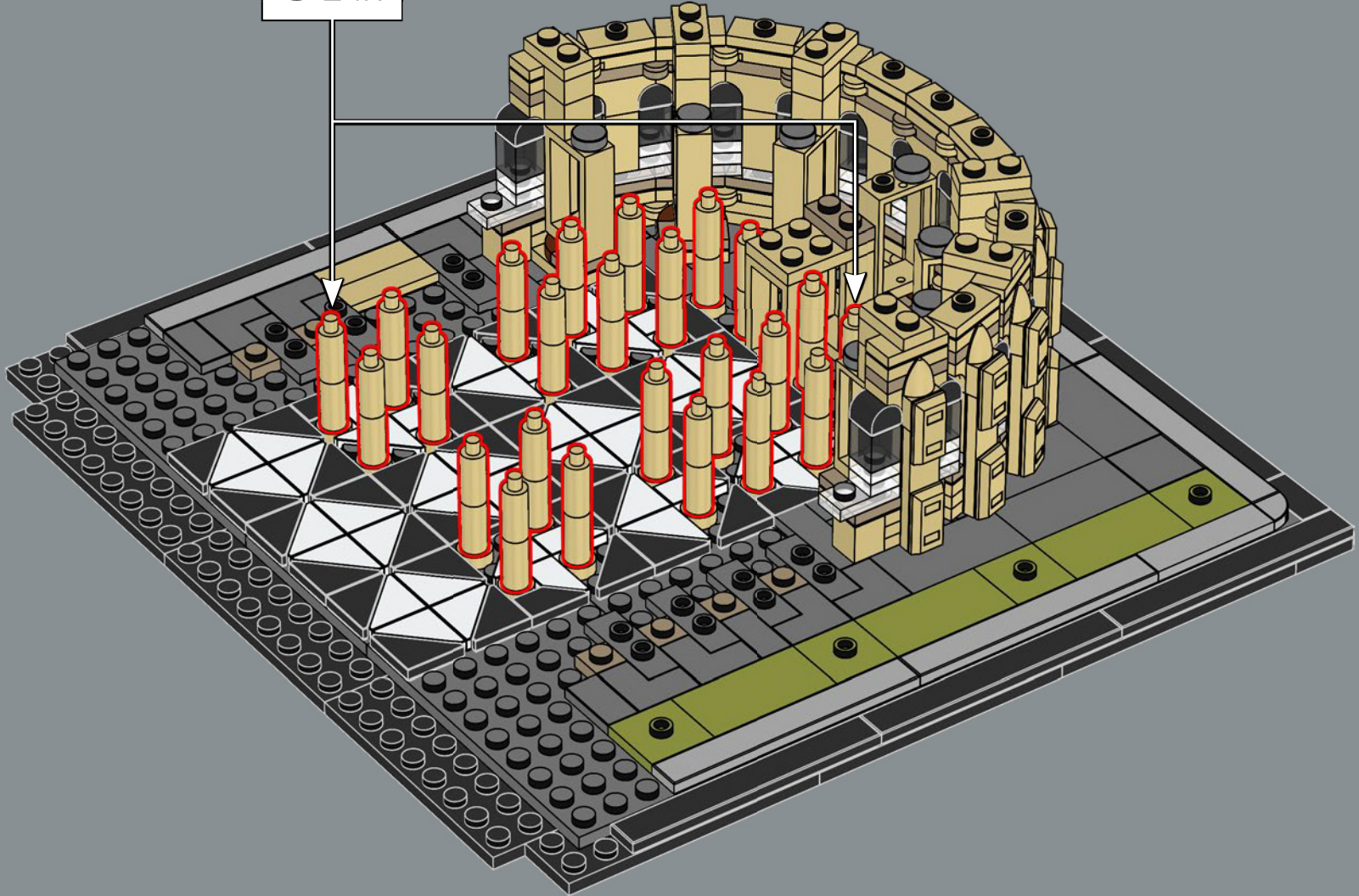
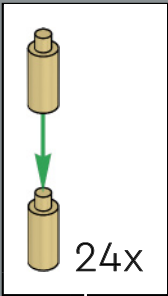

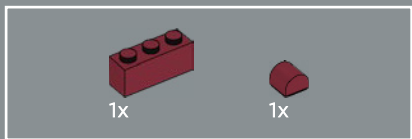

47

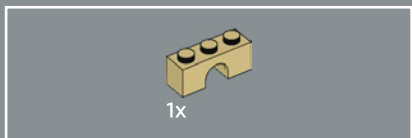
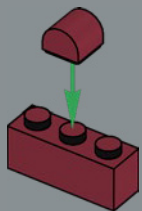

48

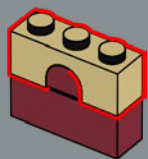

49

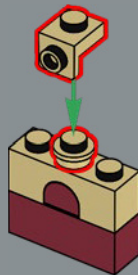

50

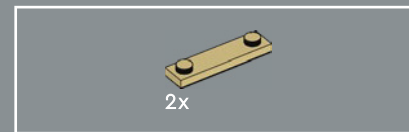
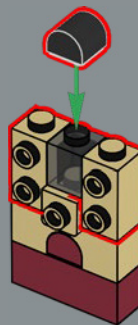

51

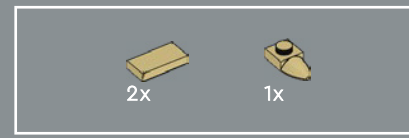
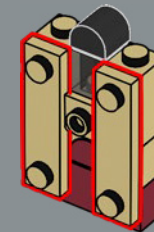

52

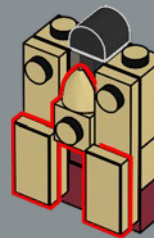

La Puerta Roja, el elegante portal que ofrece acceso directo al coro, toma su nombre del color de sus paneles. Fue renovada hacia 1270.

53

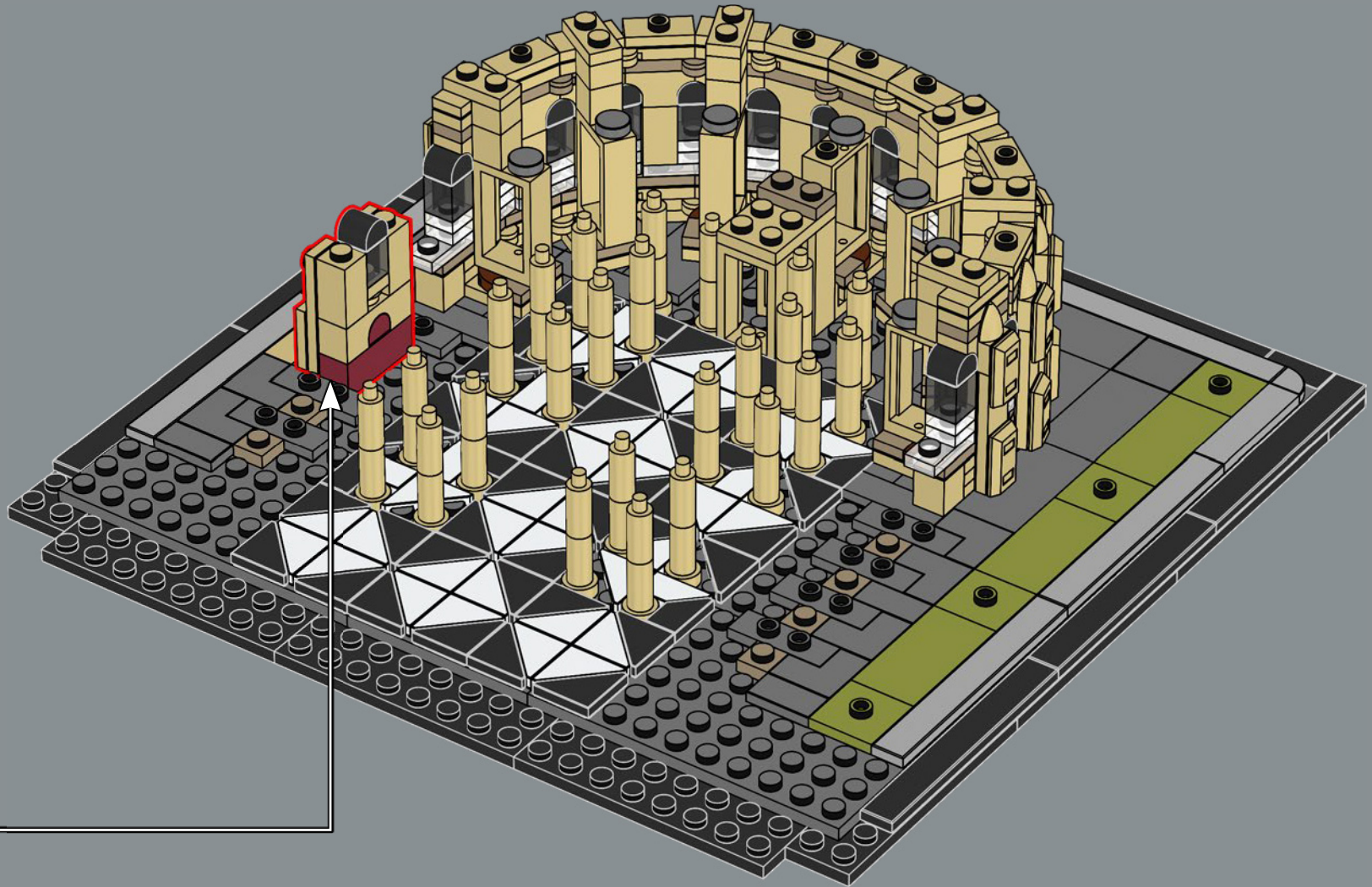

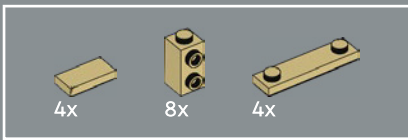

55

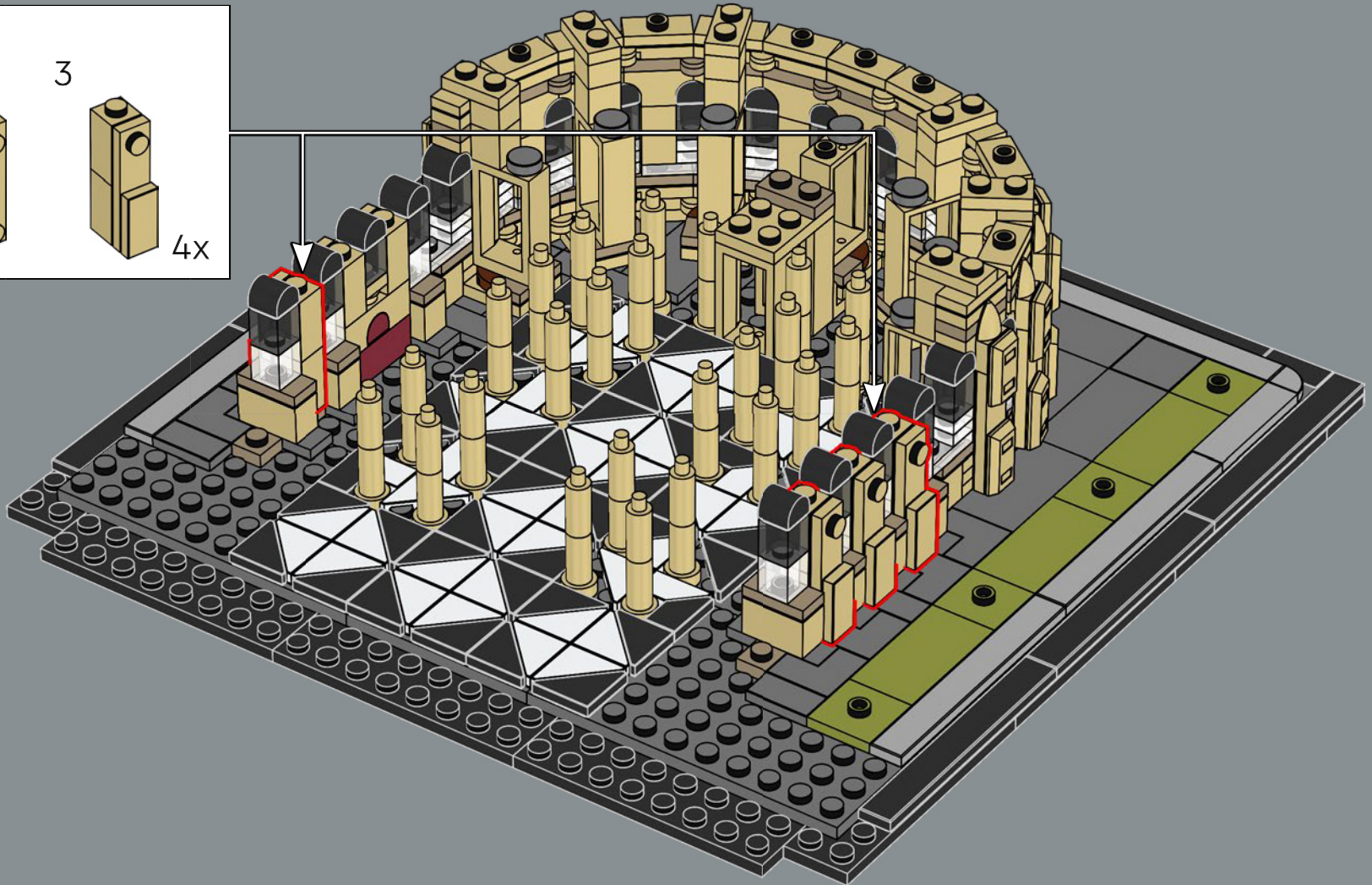
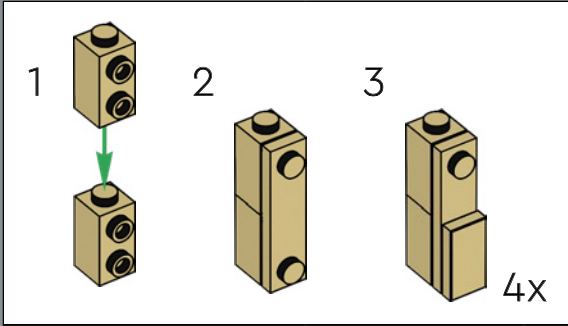

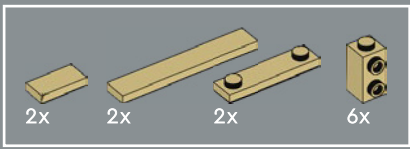

56

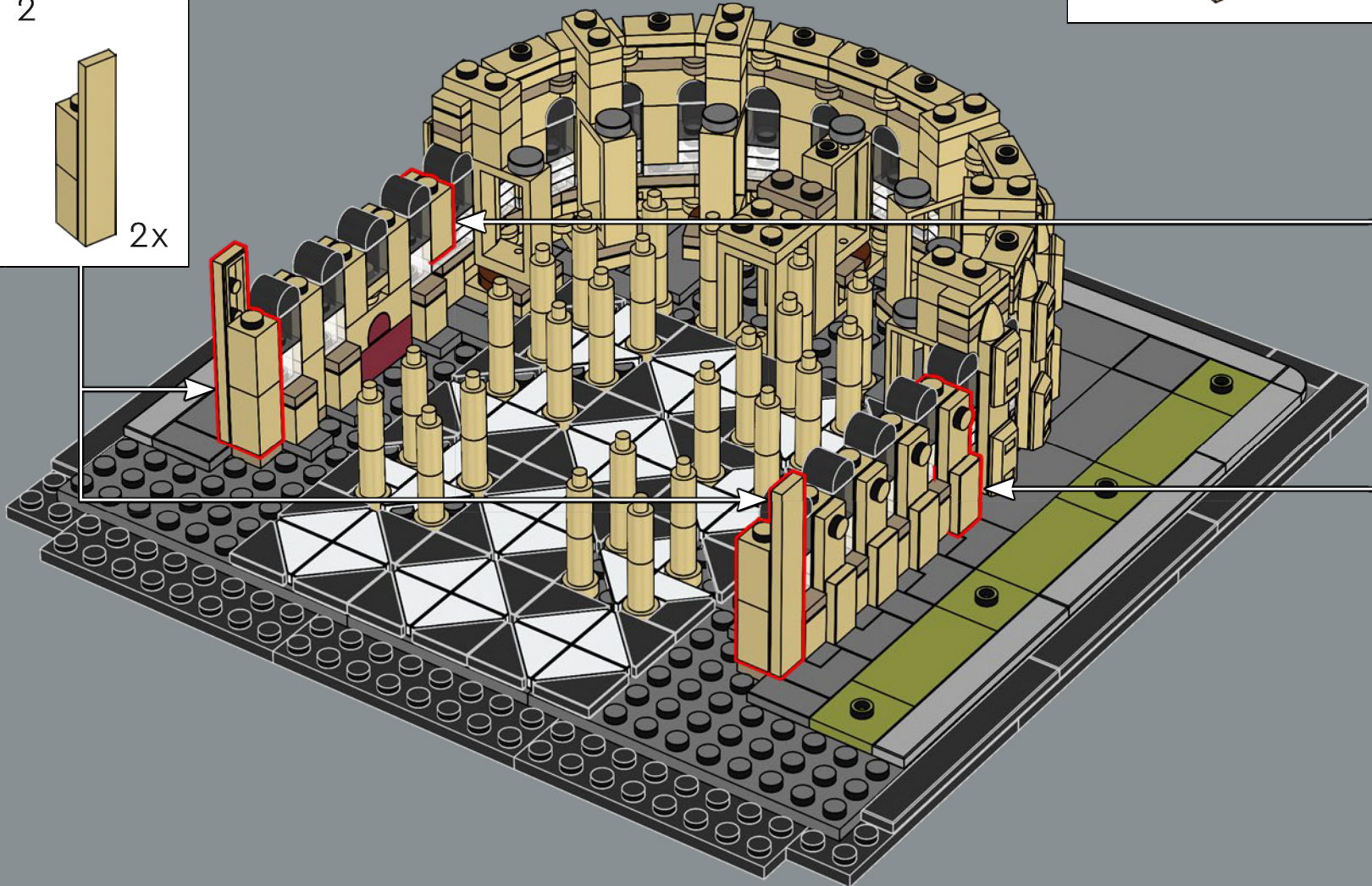
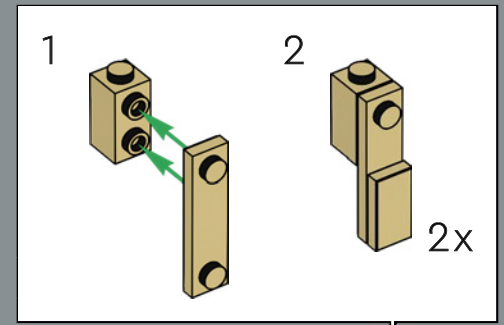
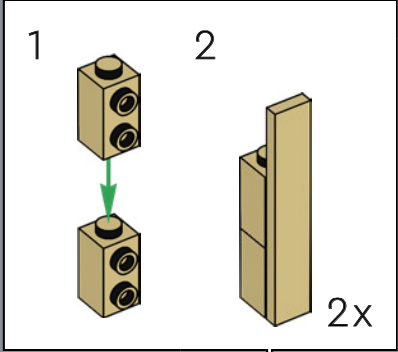

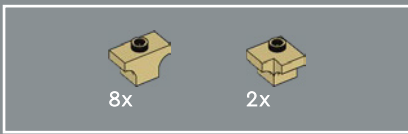

57

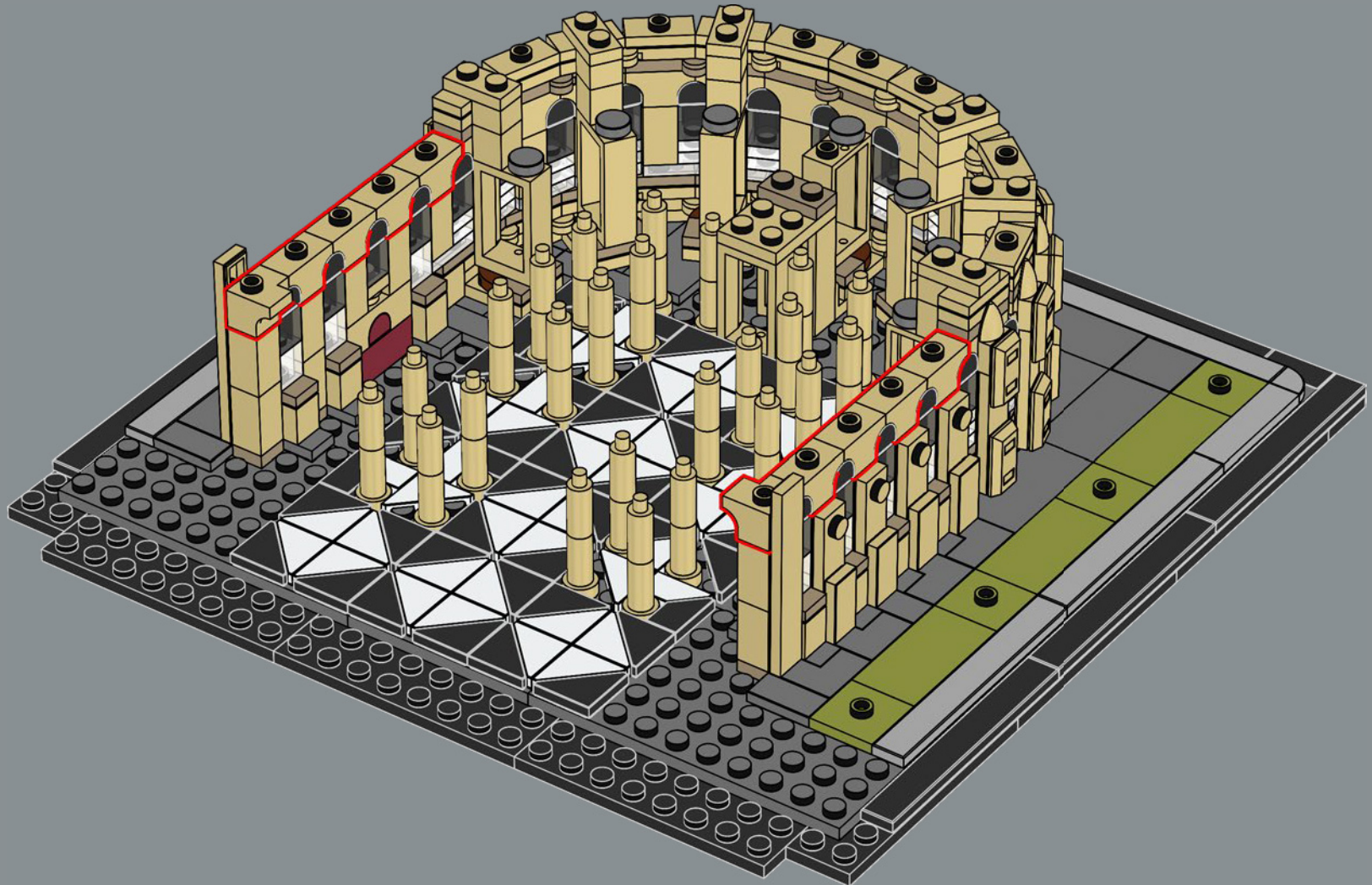

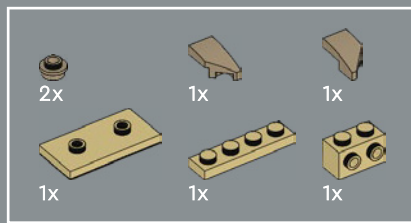

58

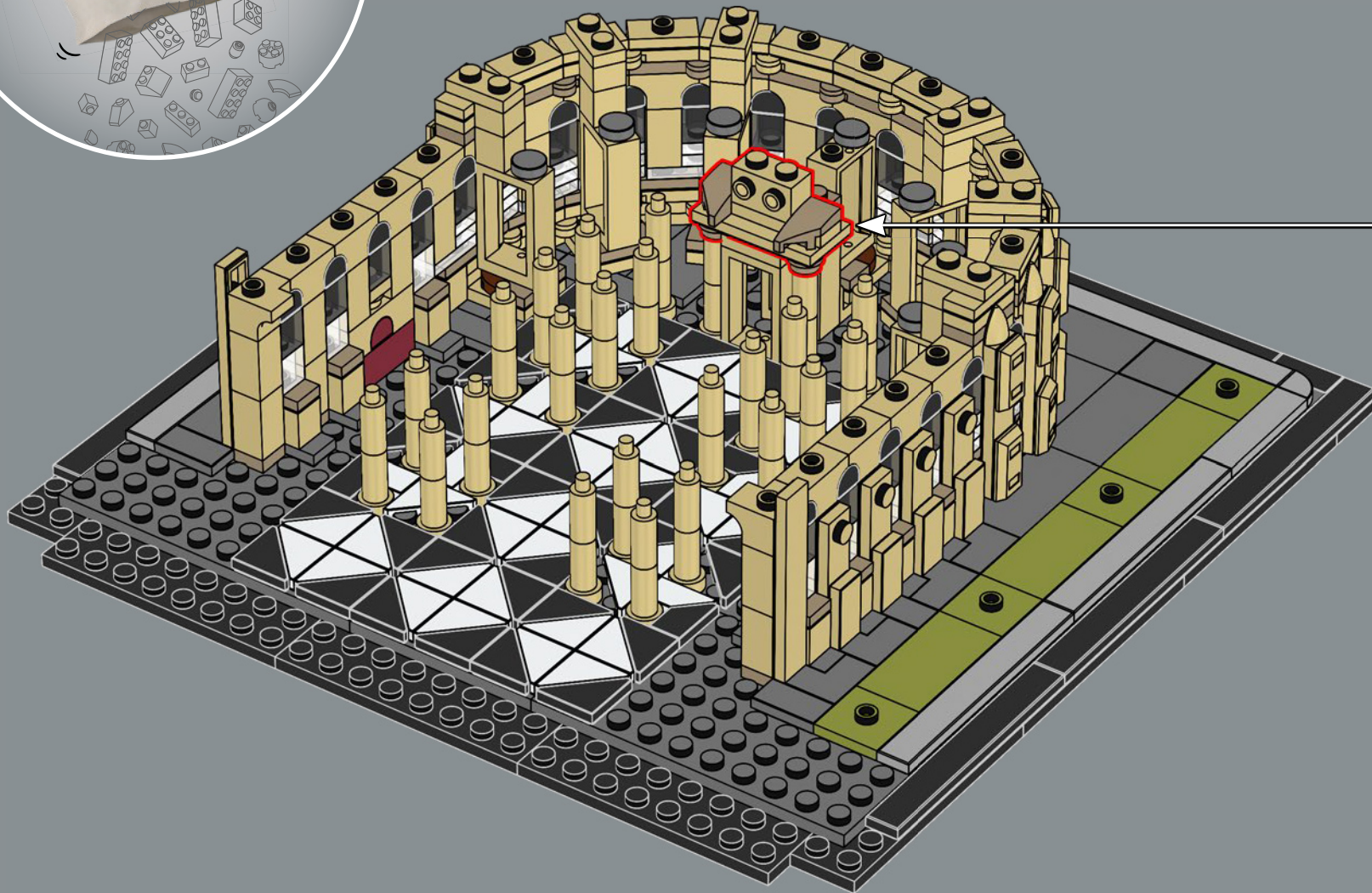
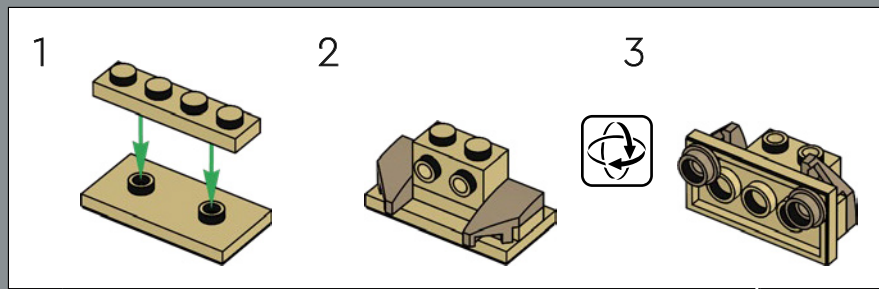

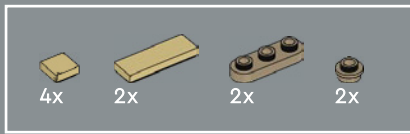

59

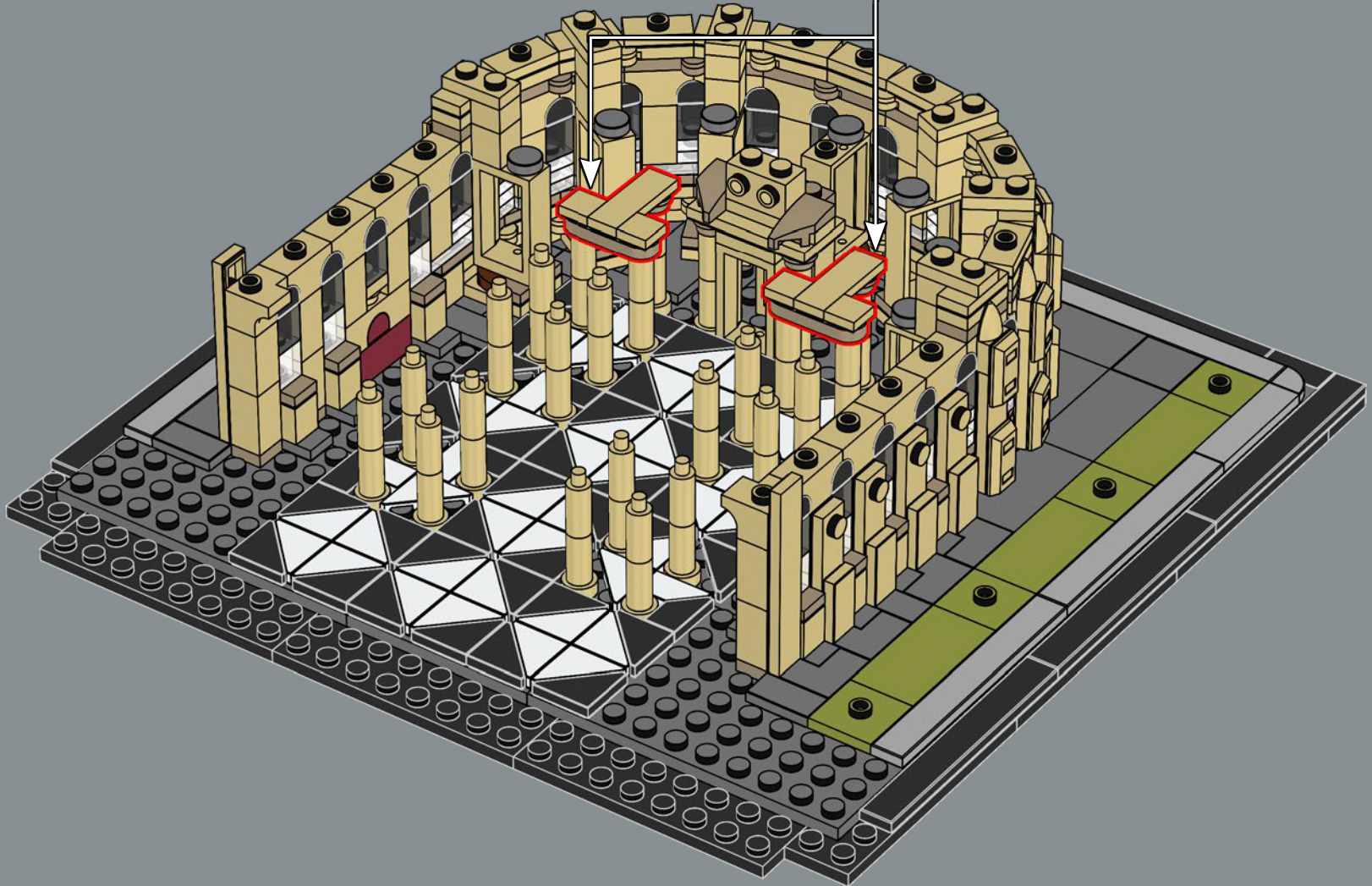
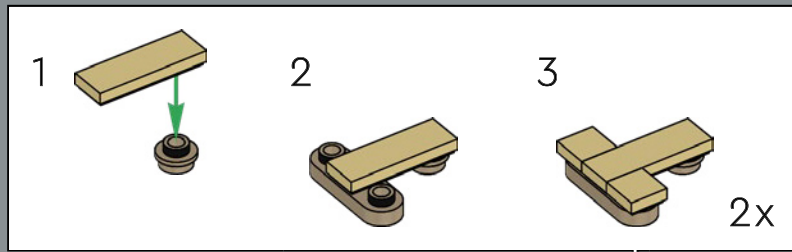

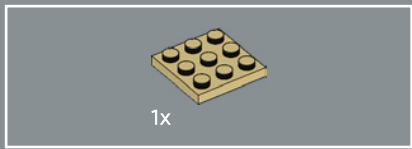

1x

60

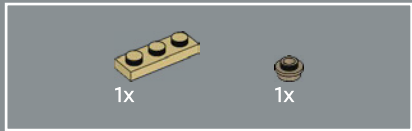

1x

1x

61

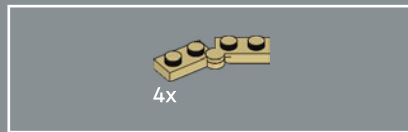
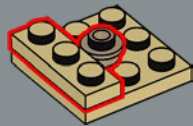

4x

62

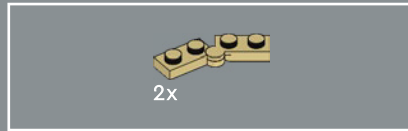
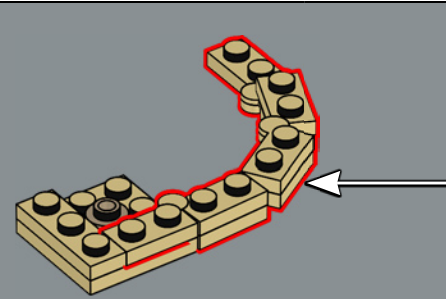
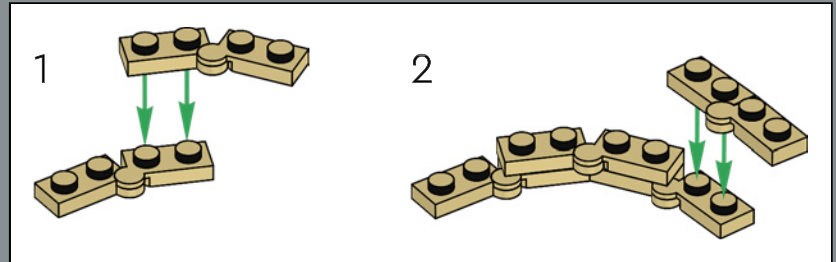

2x

63

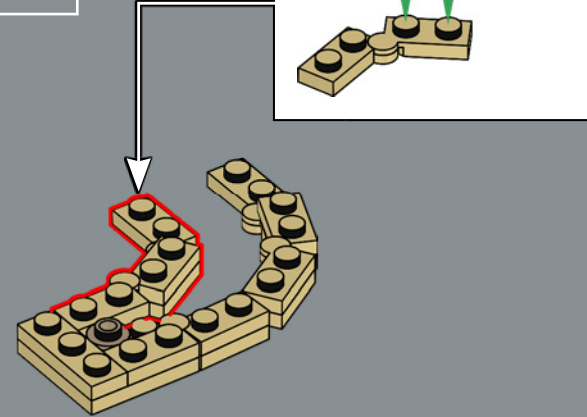

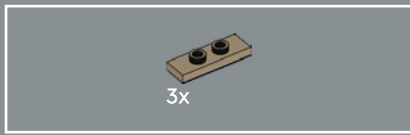

64

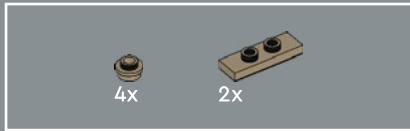
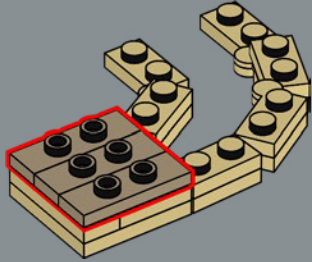

65

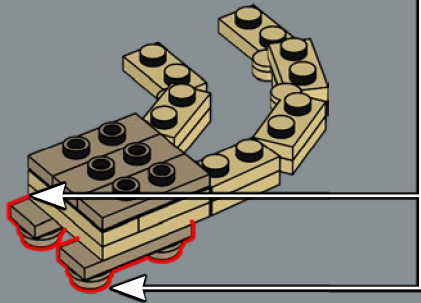
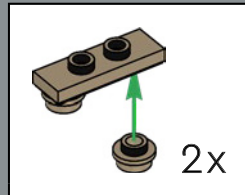

66

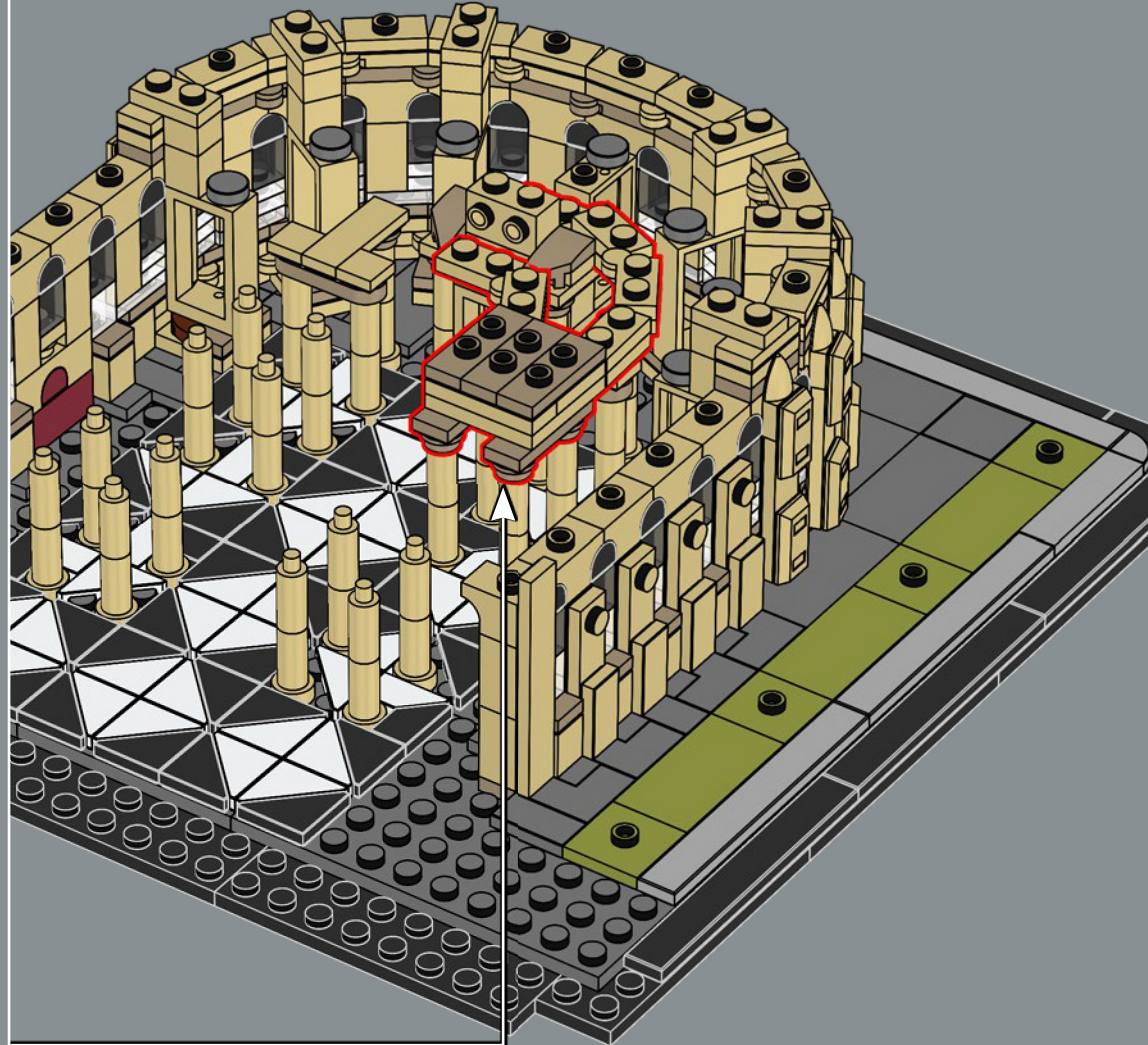

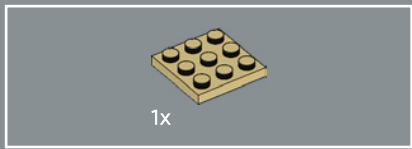

67

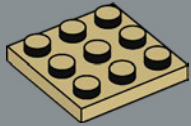

68

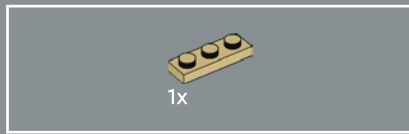
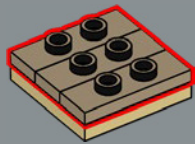

69

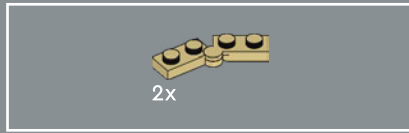
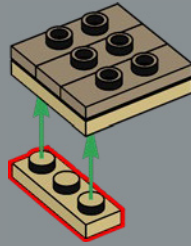

70

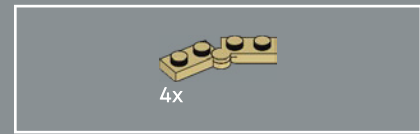
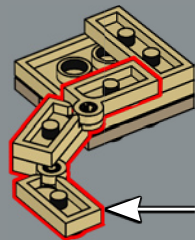
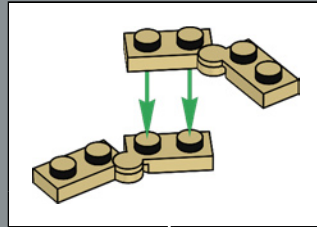

71

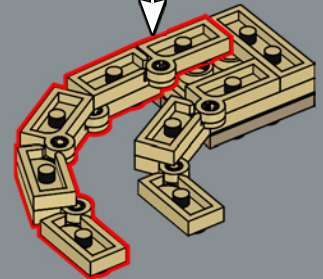
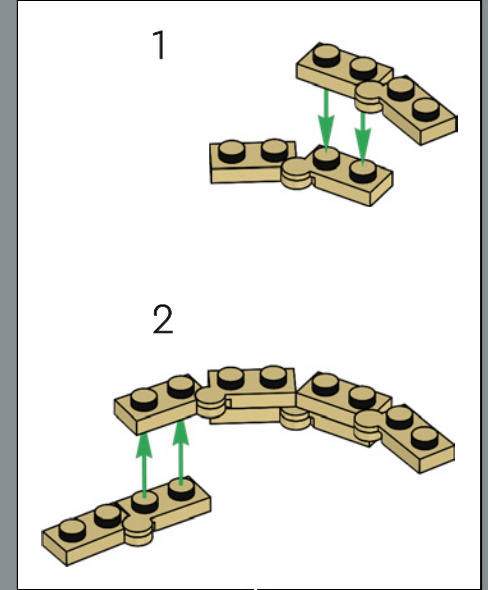

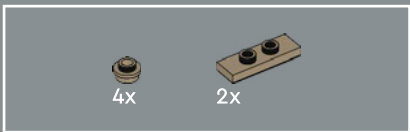

72

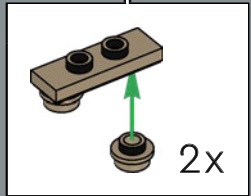
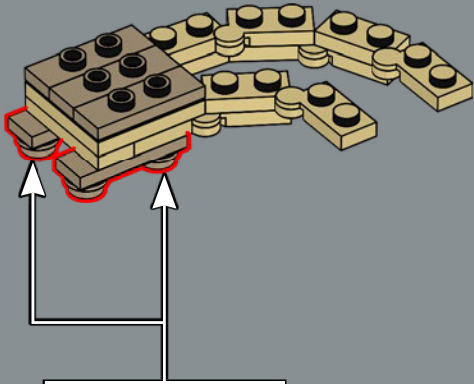

73

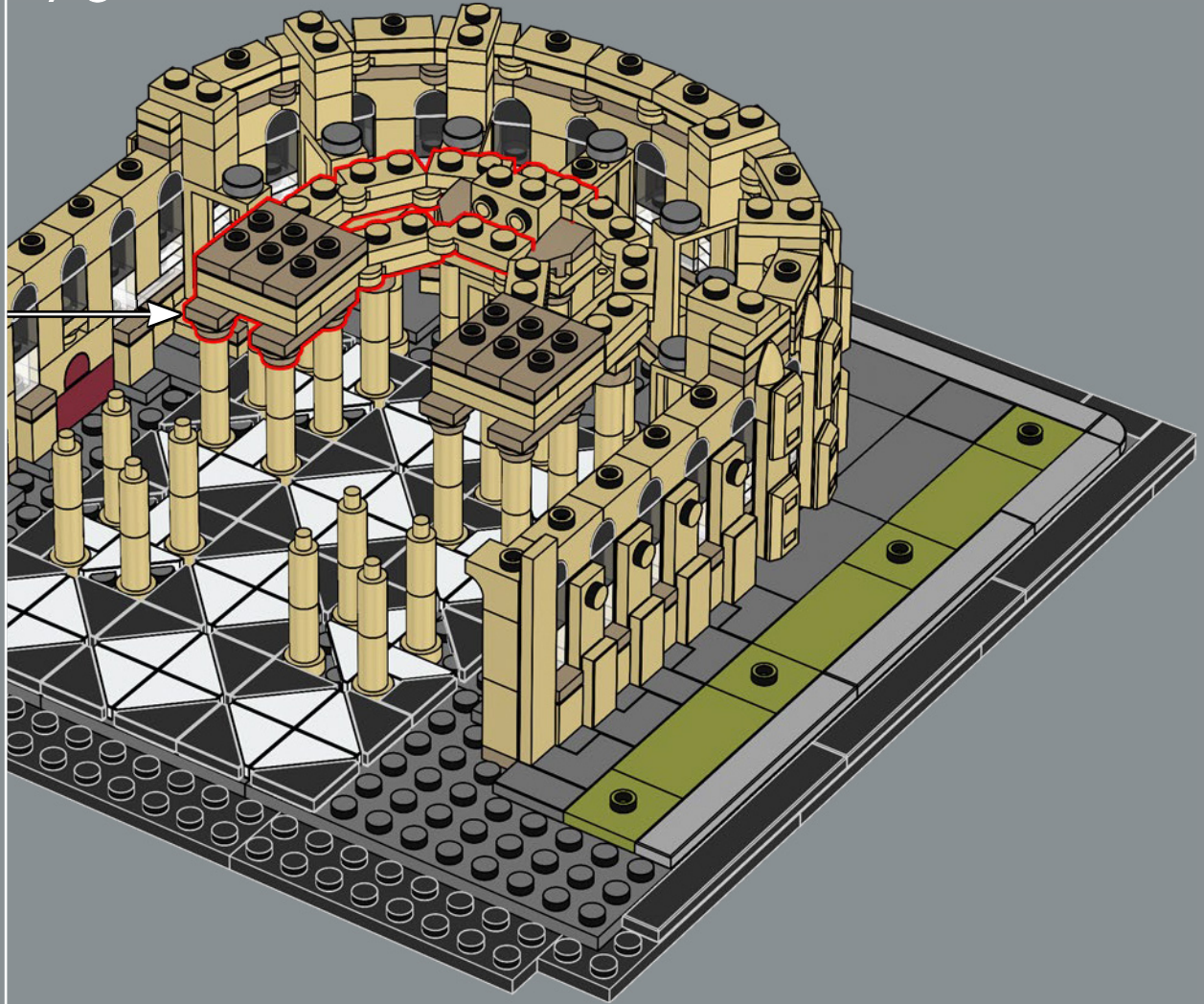

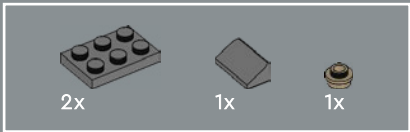

74

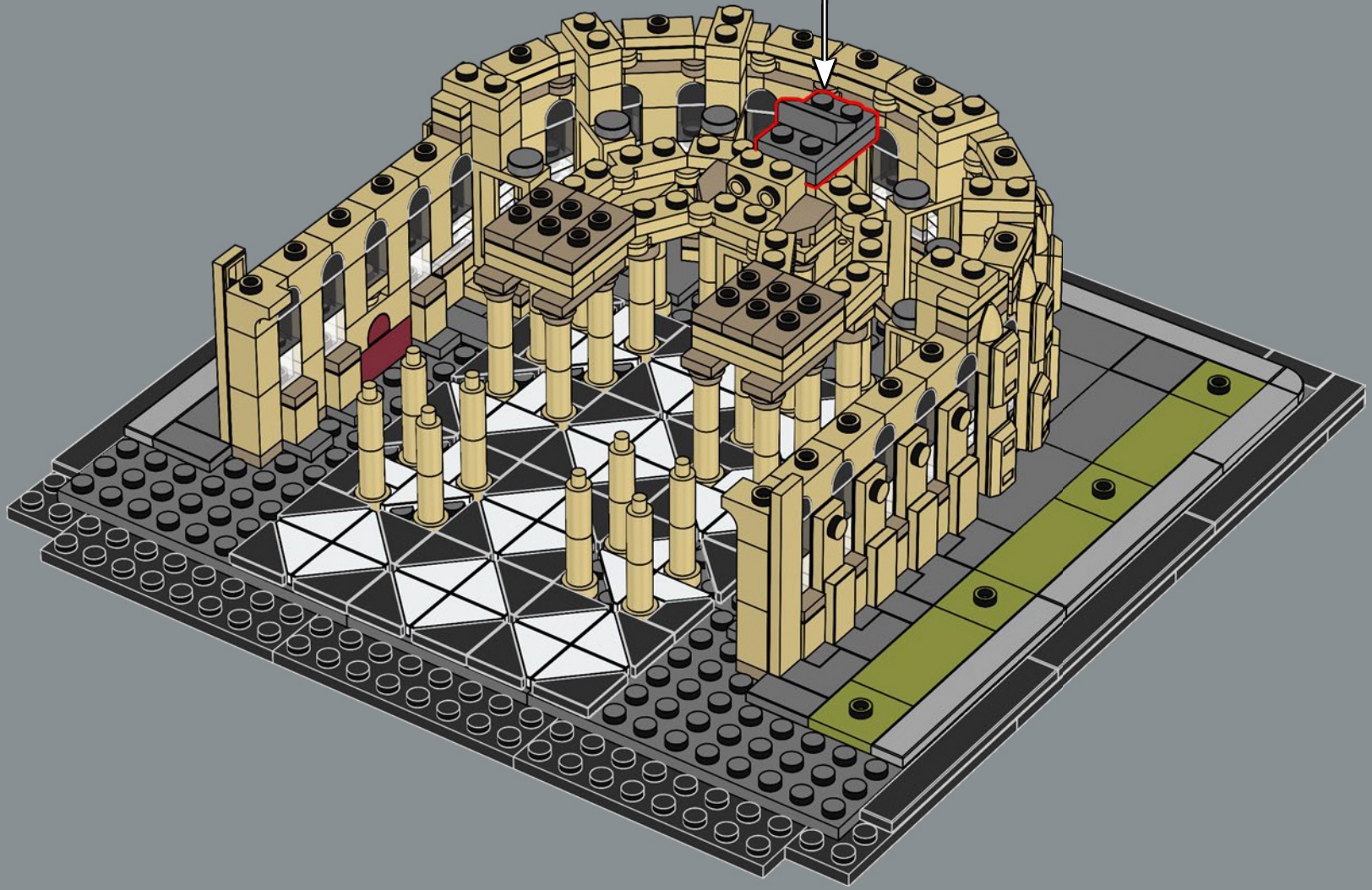
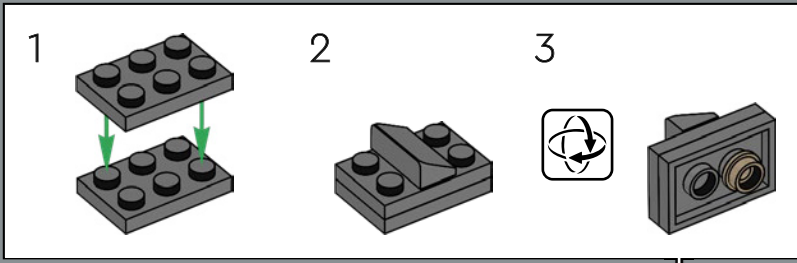

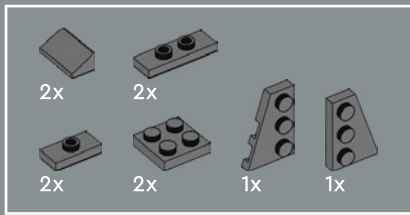

75

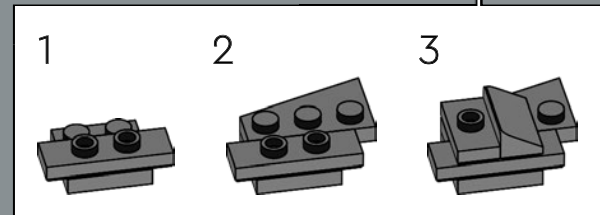
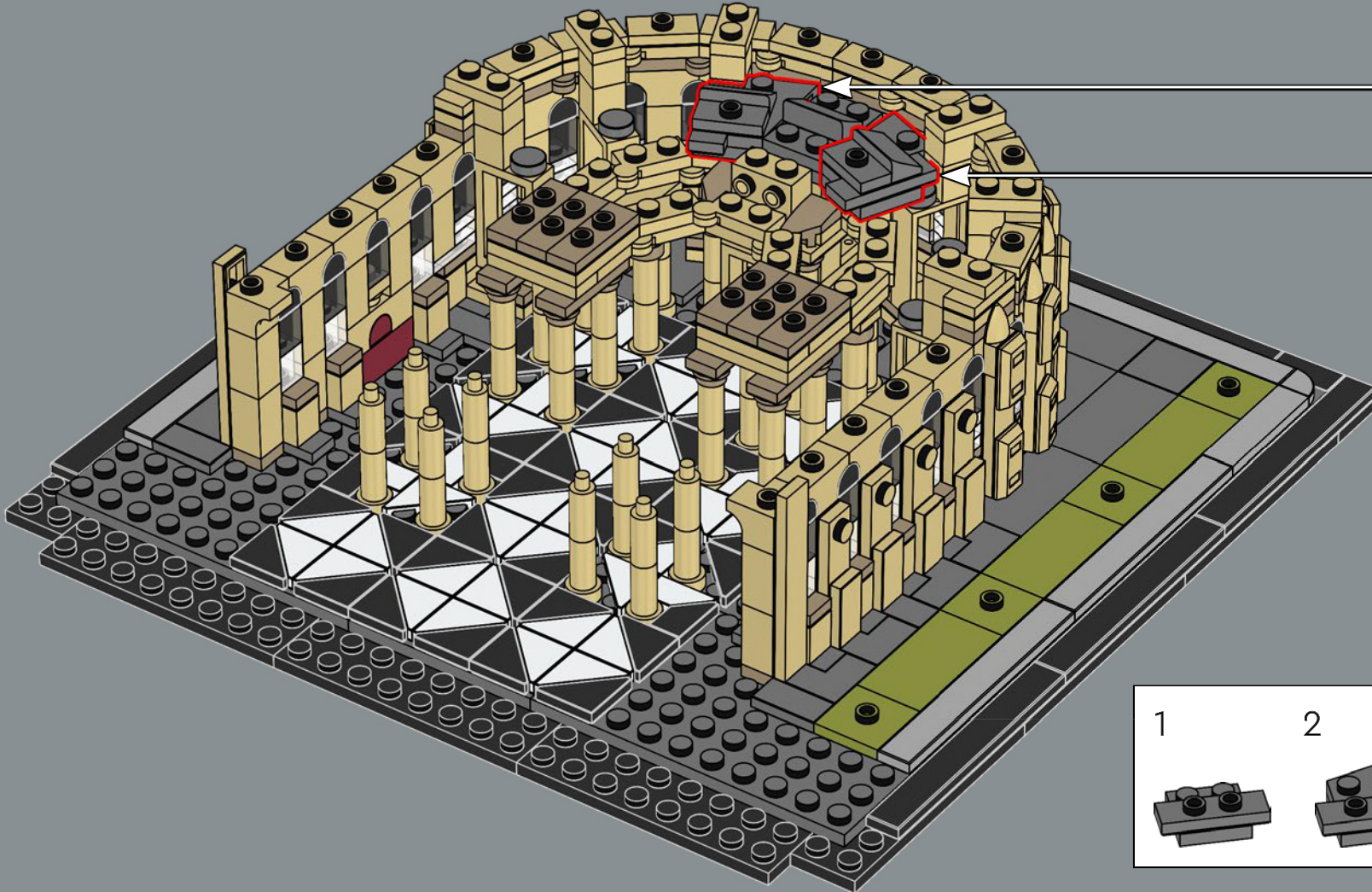
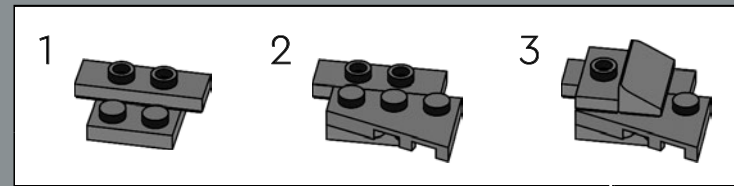

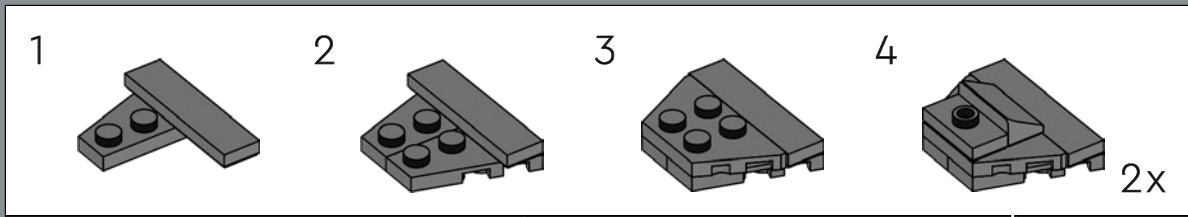
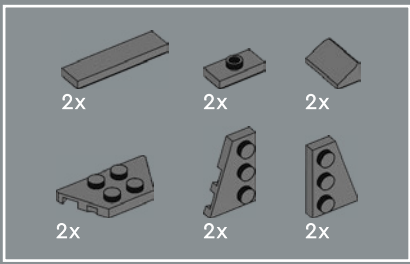

76

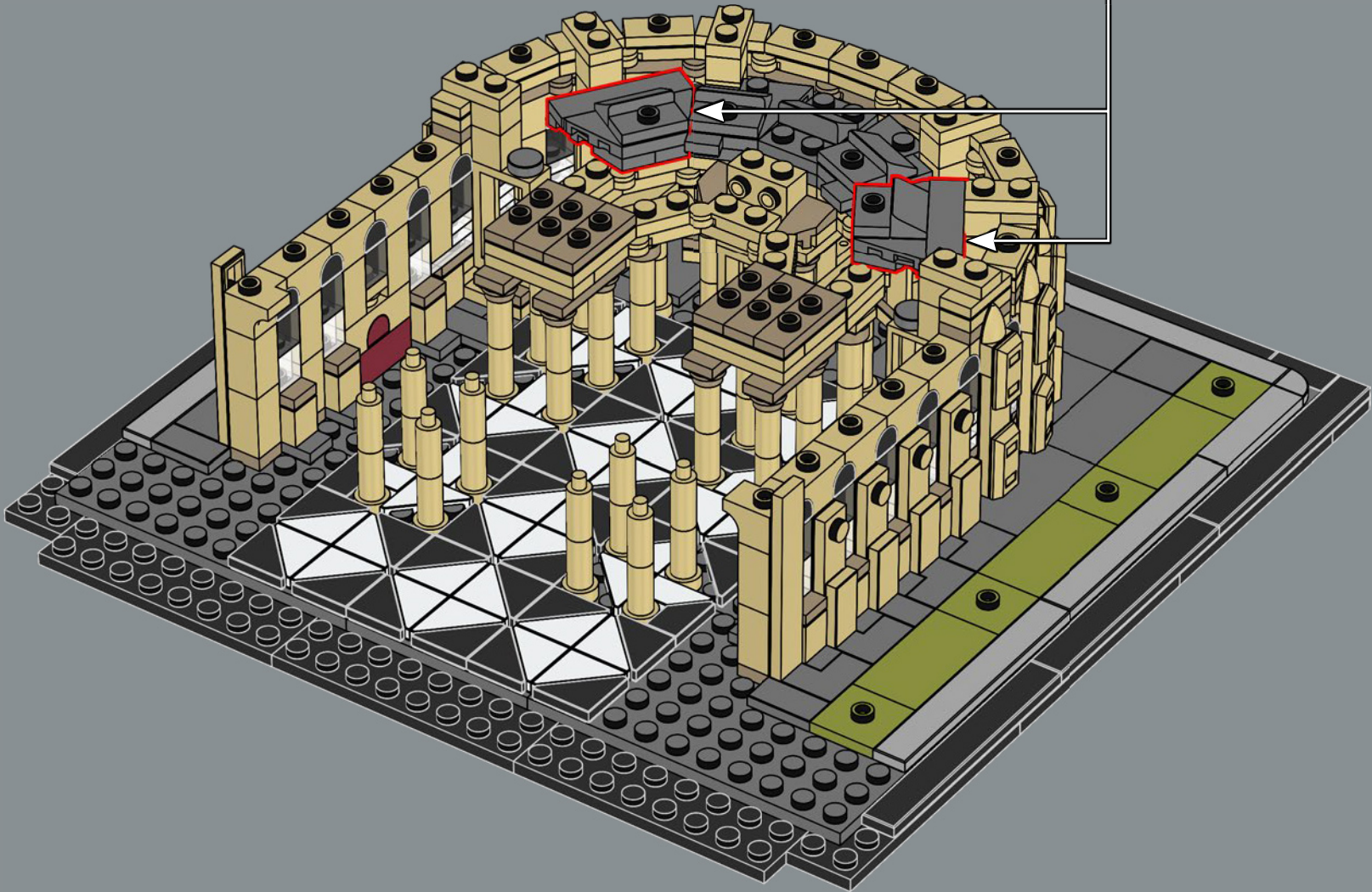

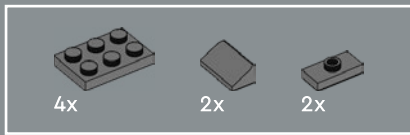

77

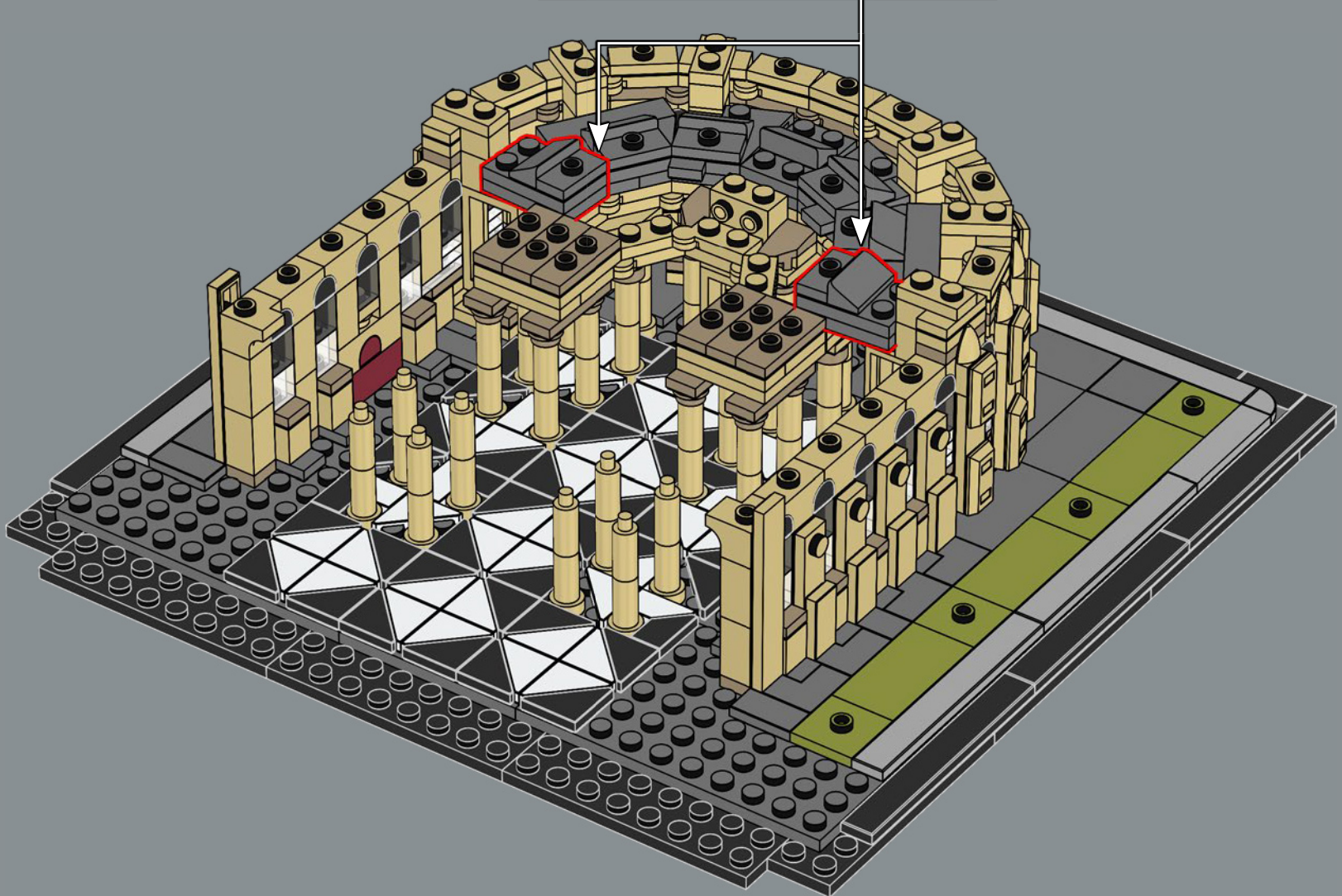
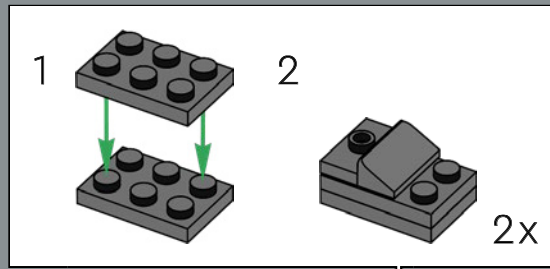



78

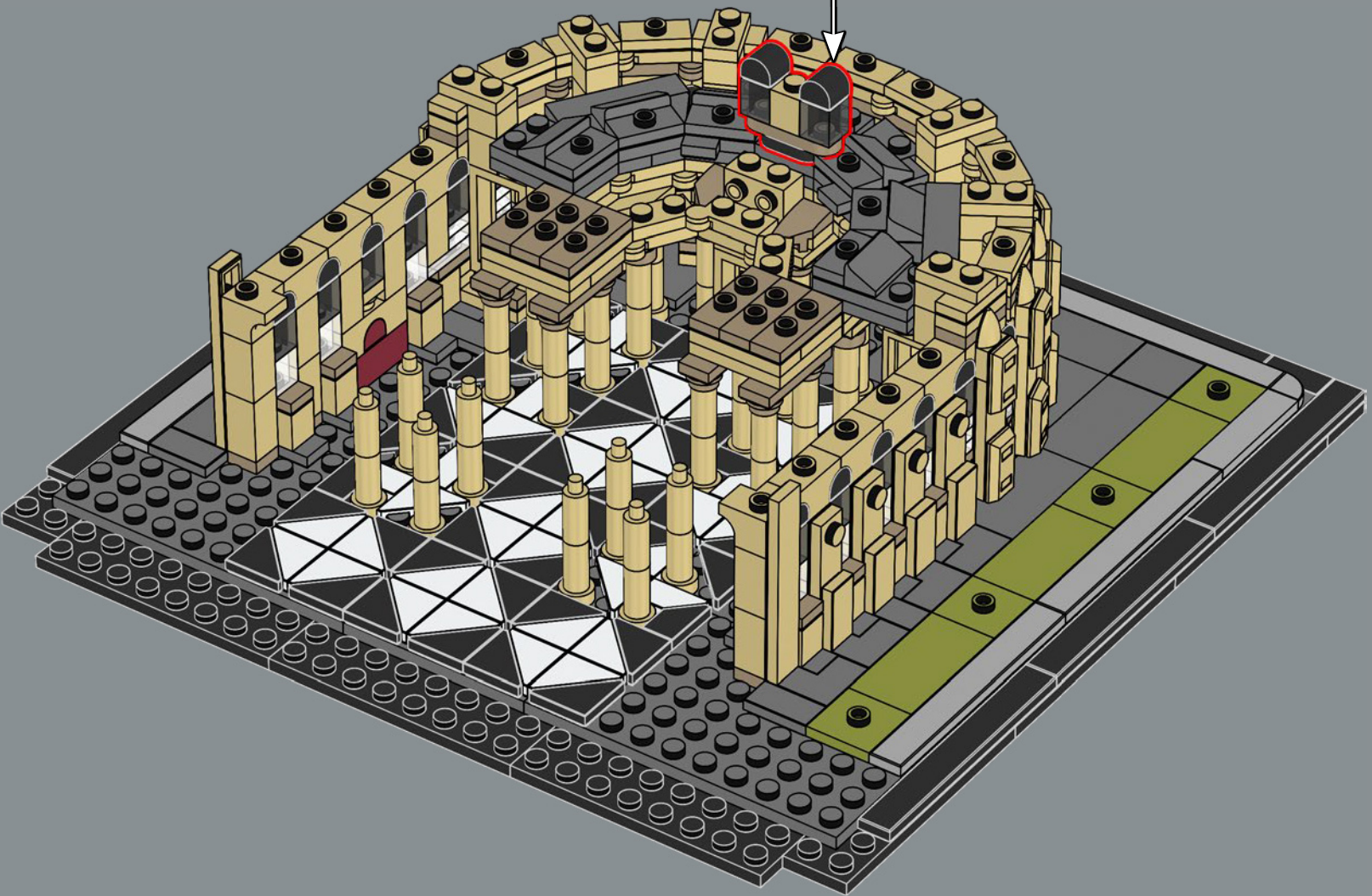
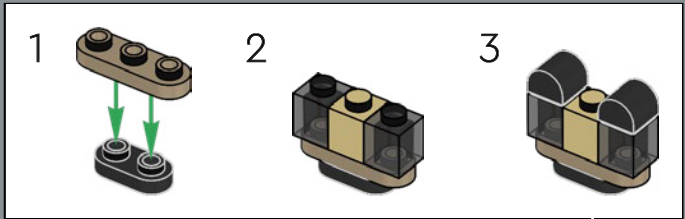



79

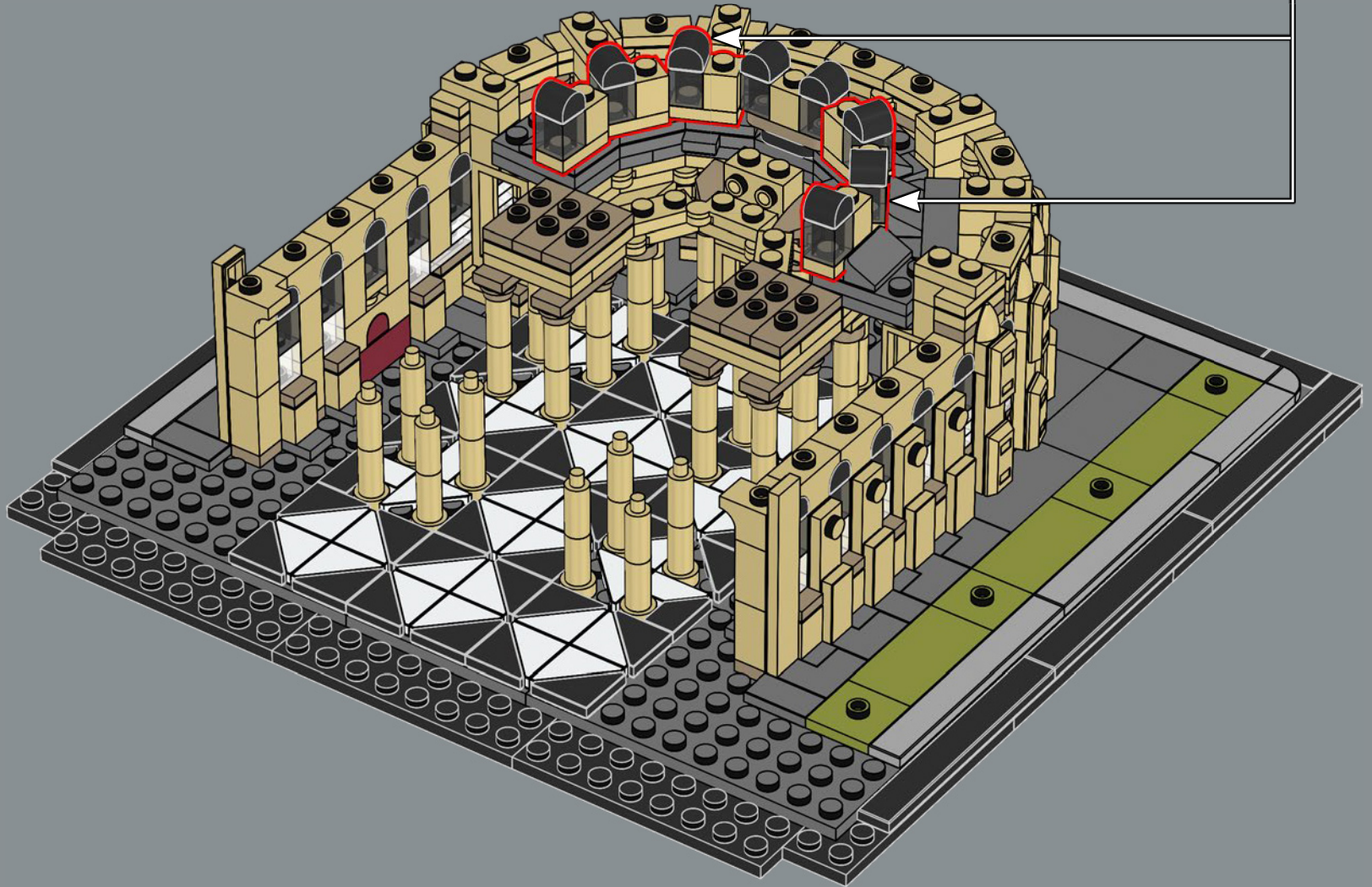
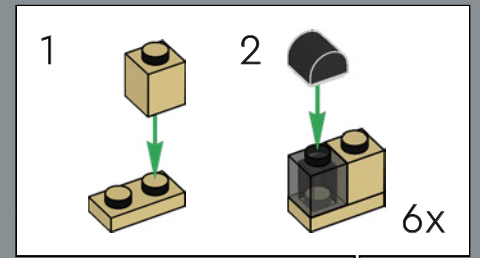



7x

80

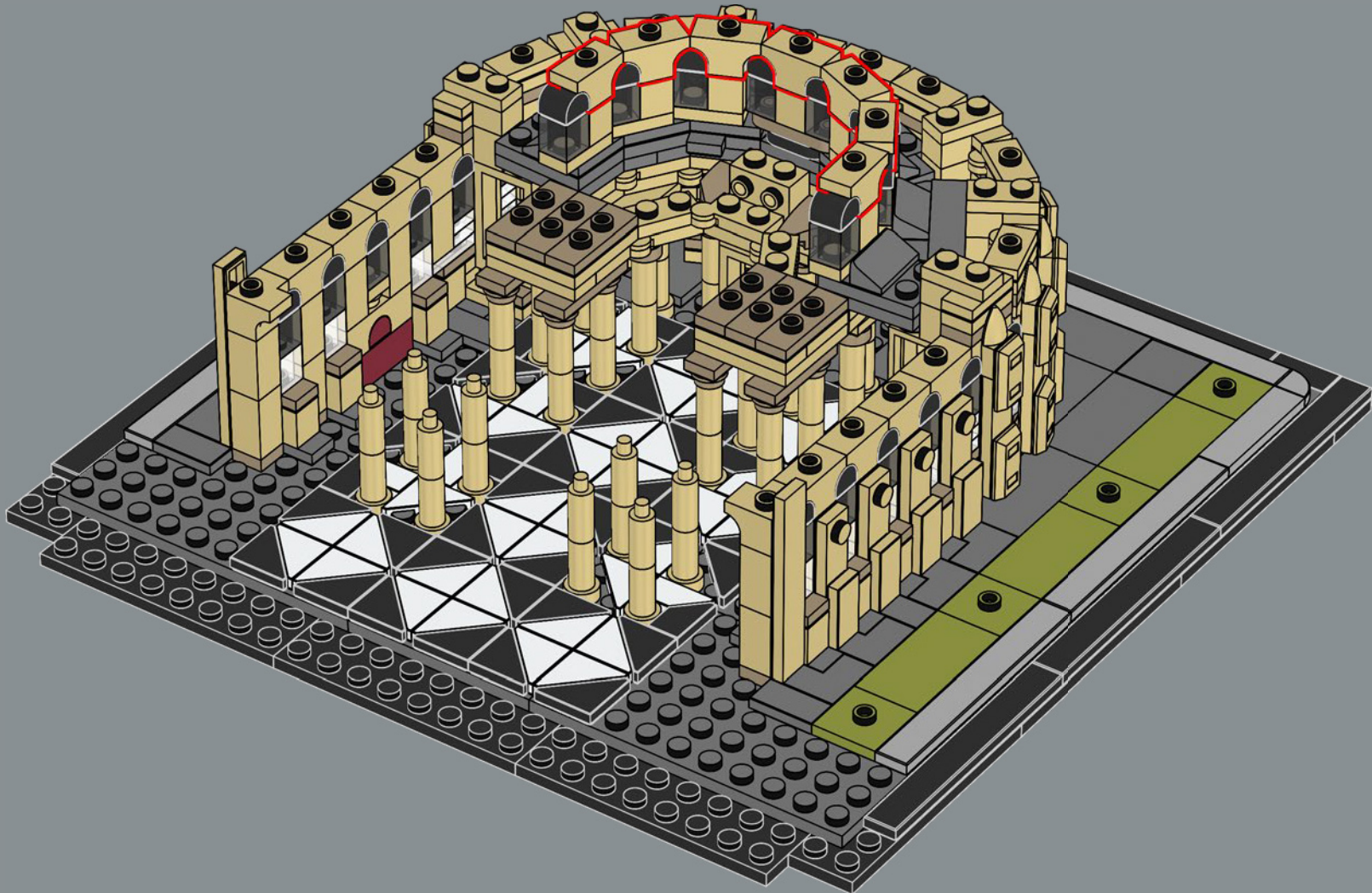

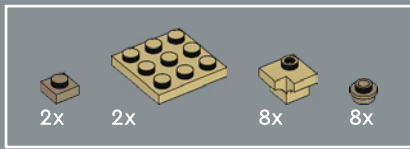

81

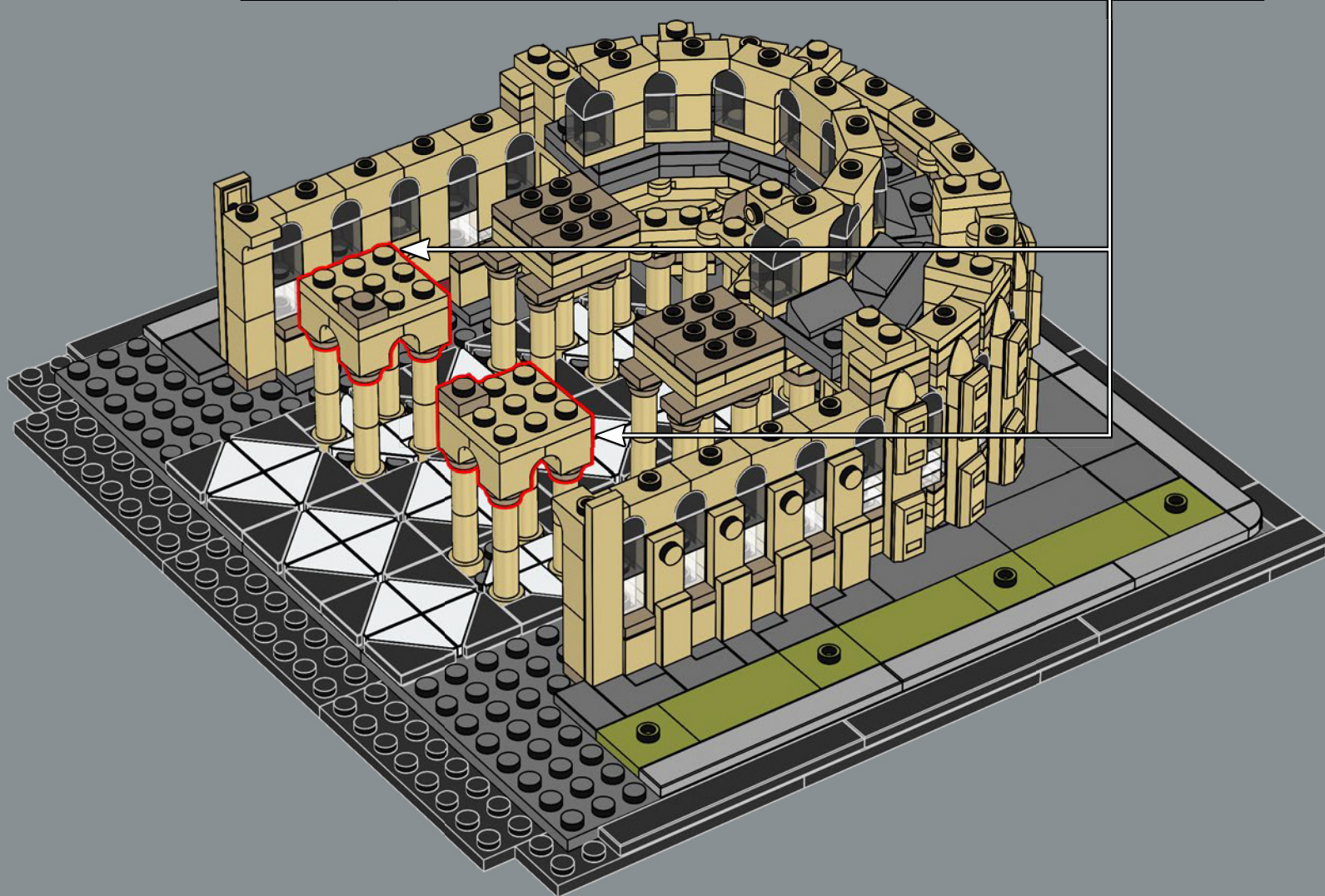
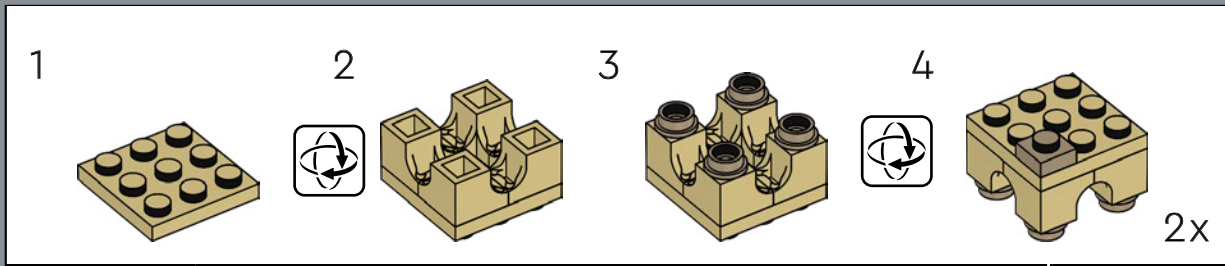

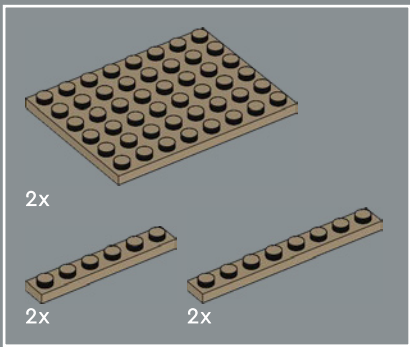

82

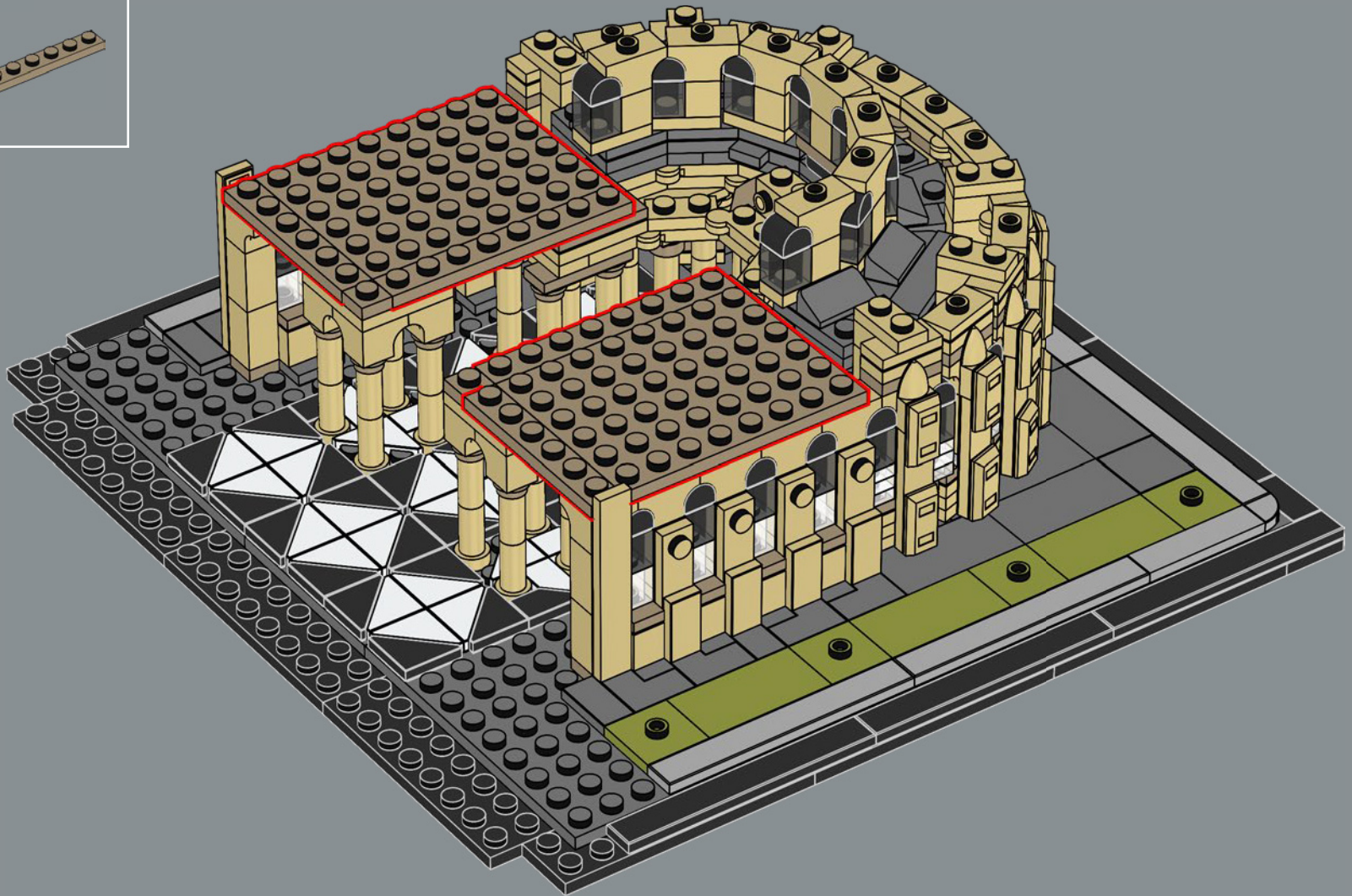

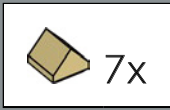

83

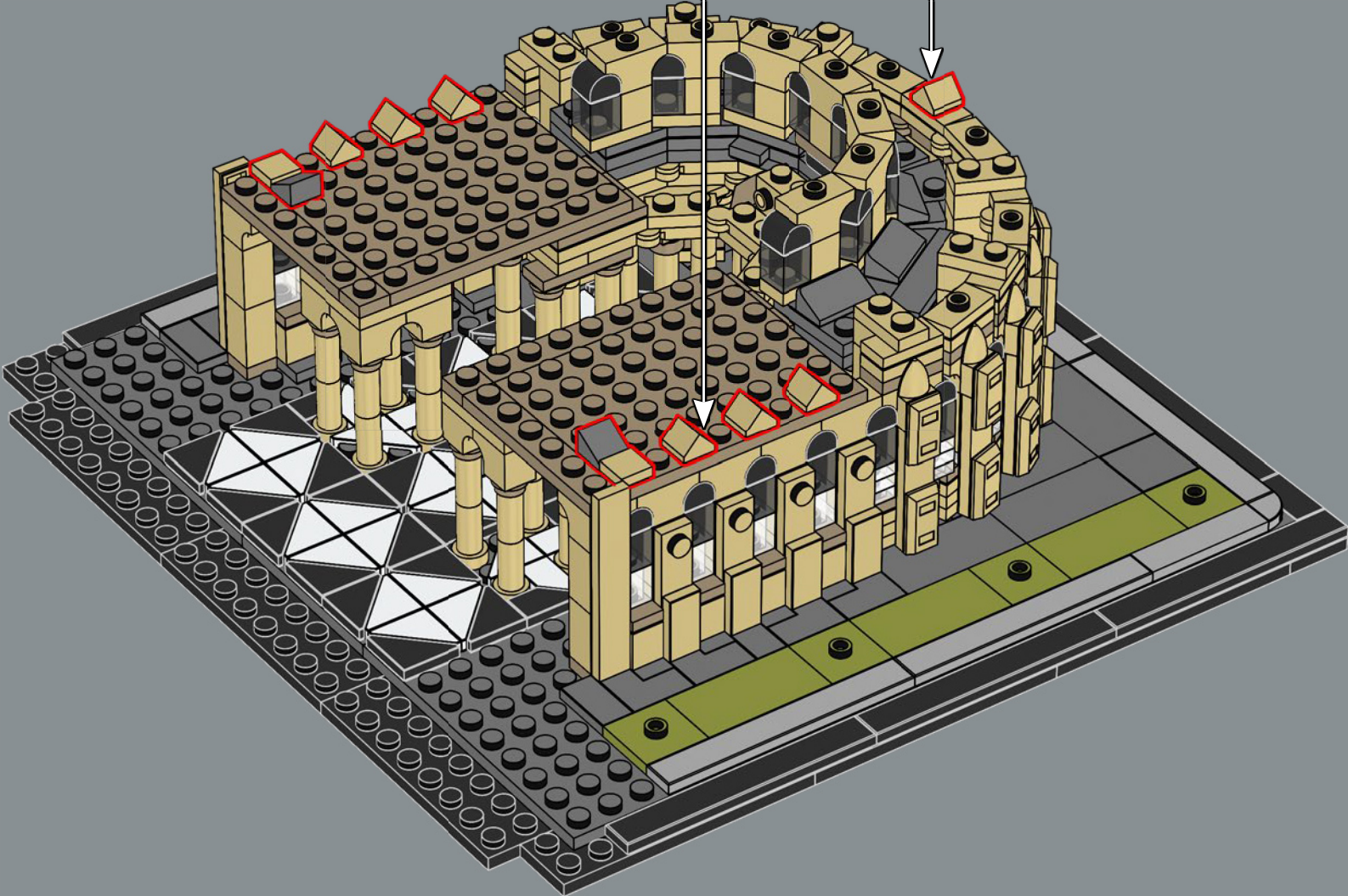

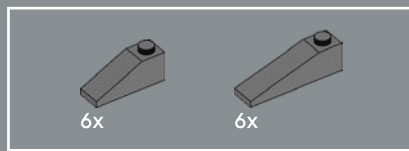

84

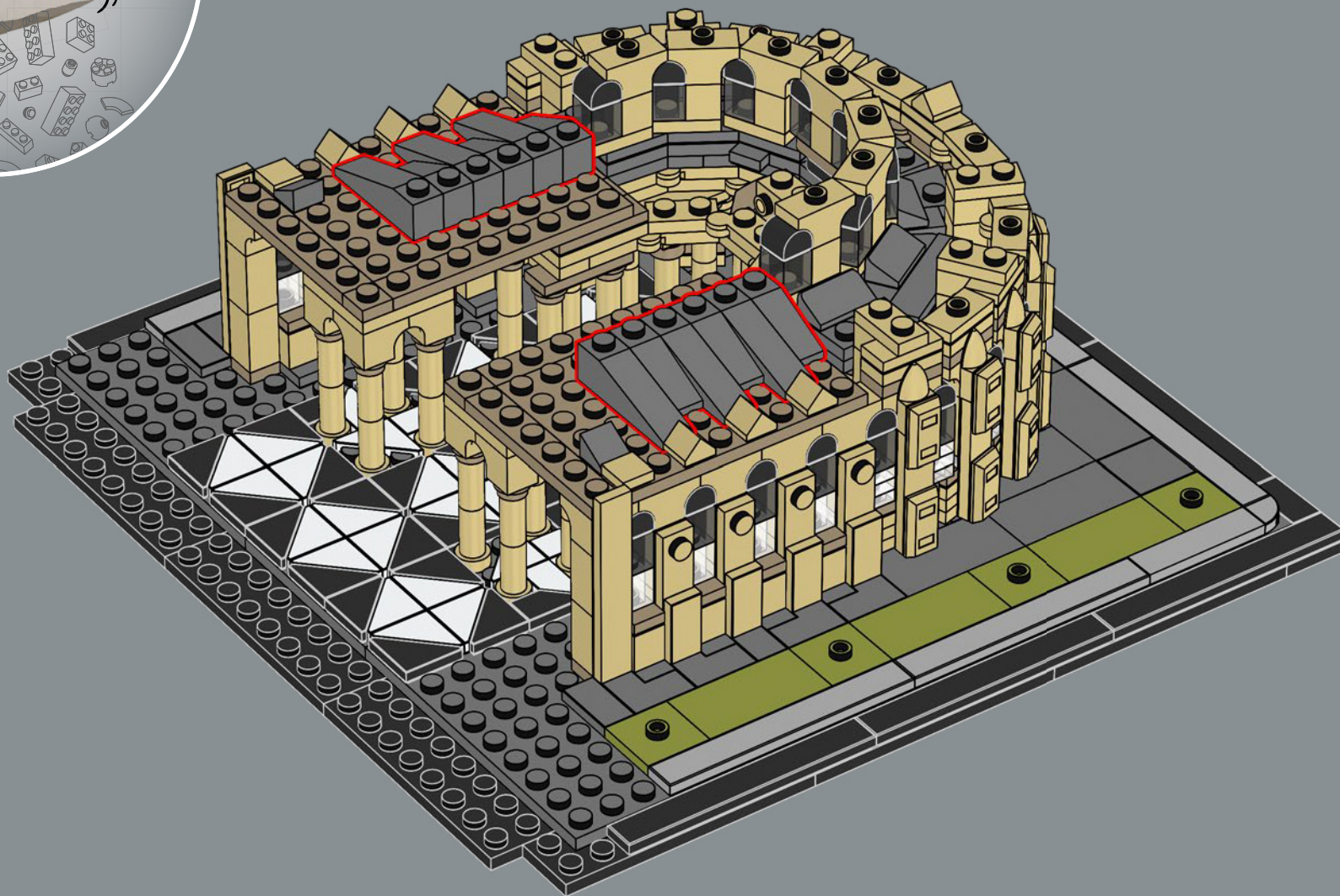

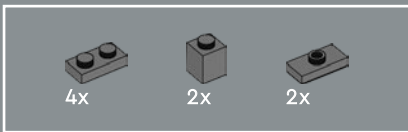

85

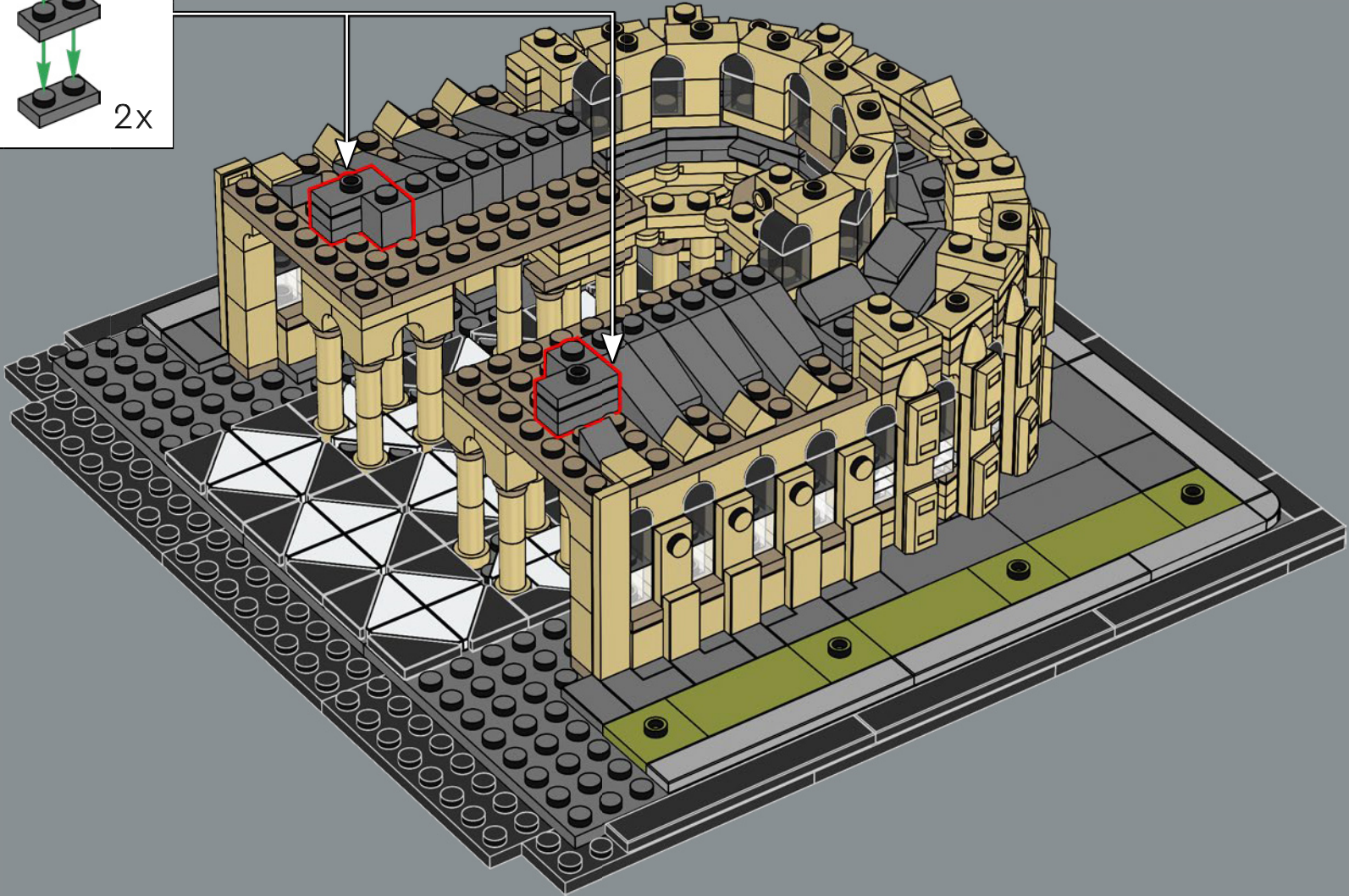
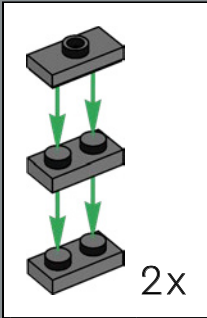



12x

86

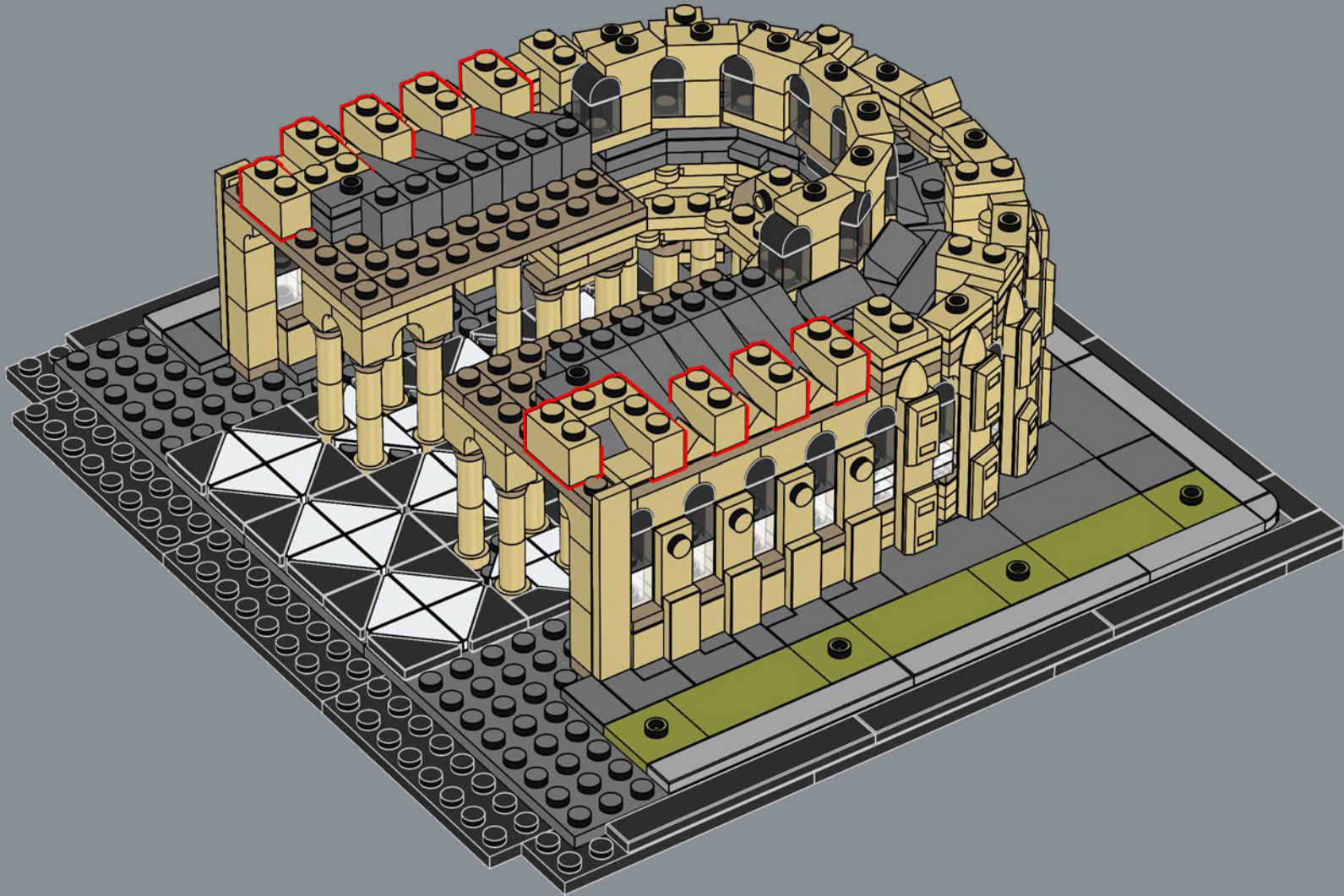

- 
8x
- 
8x
- 
2x
- 
14x
- 
8x

87

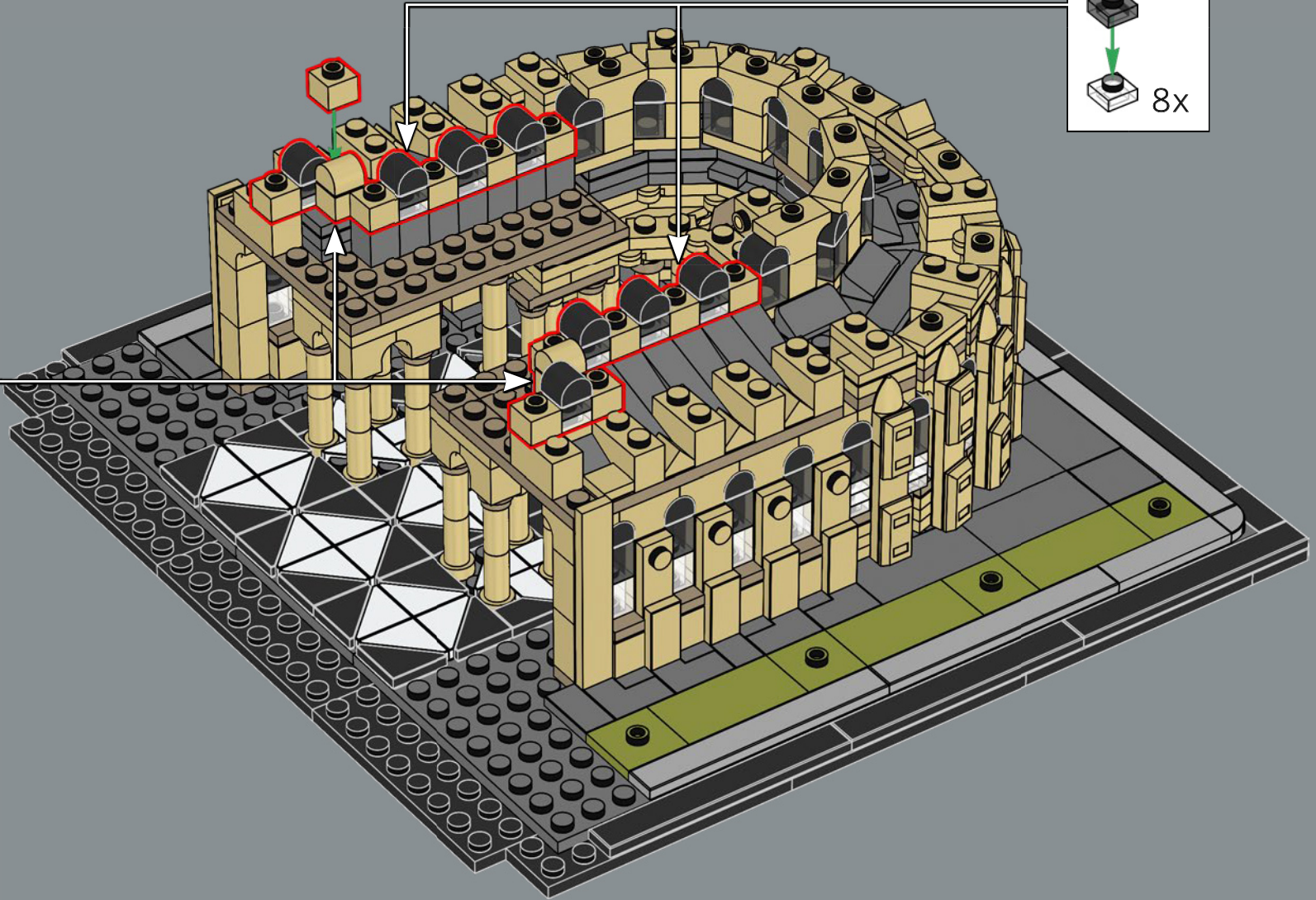
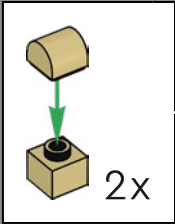
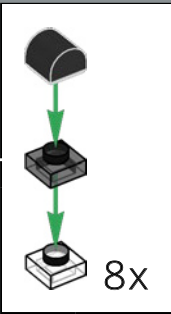

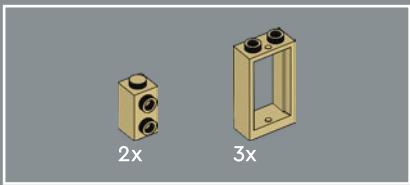

88

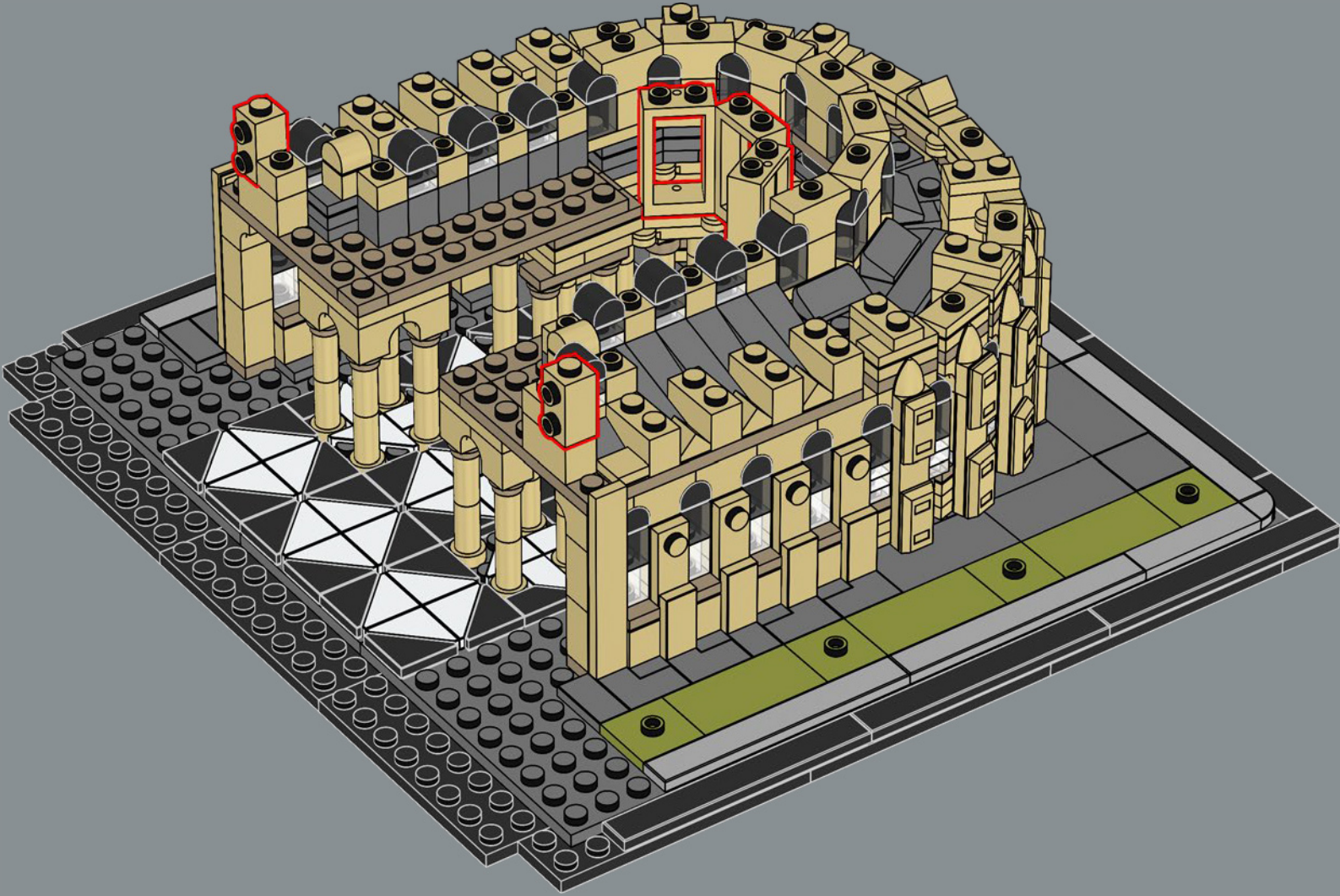

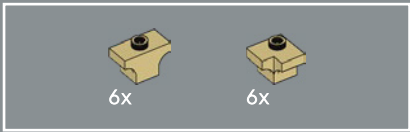

89

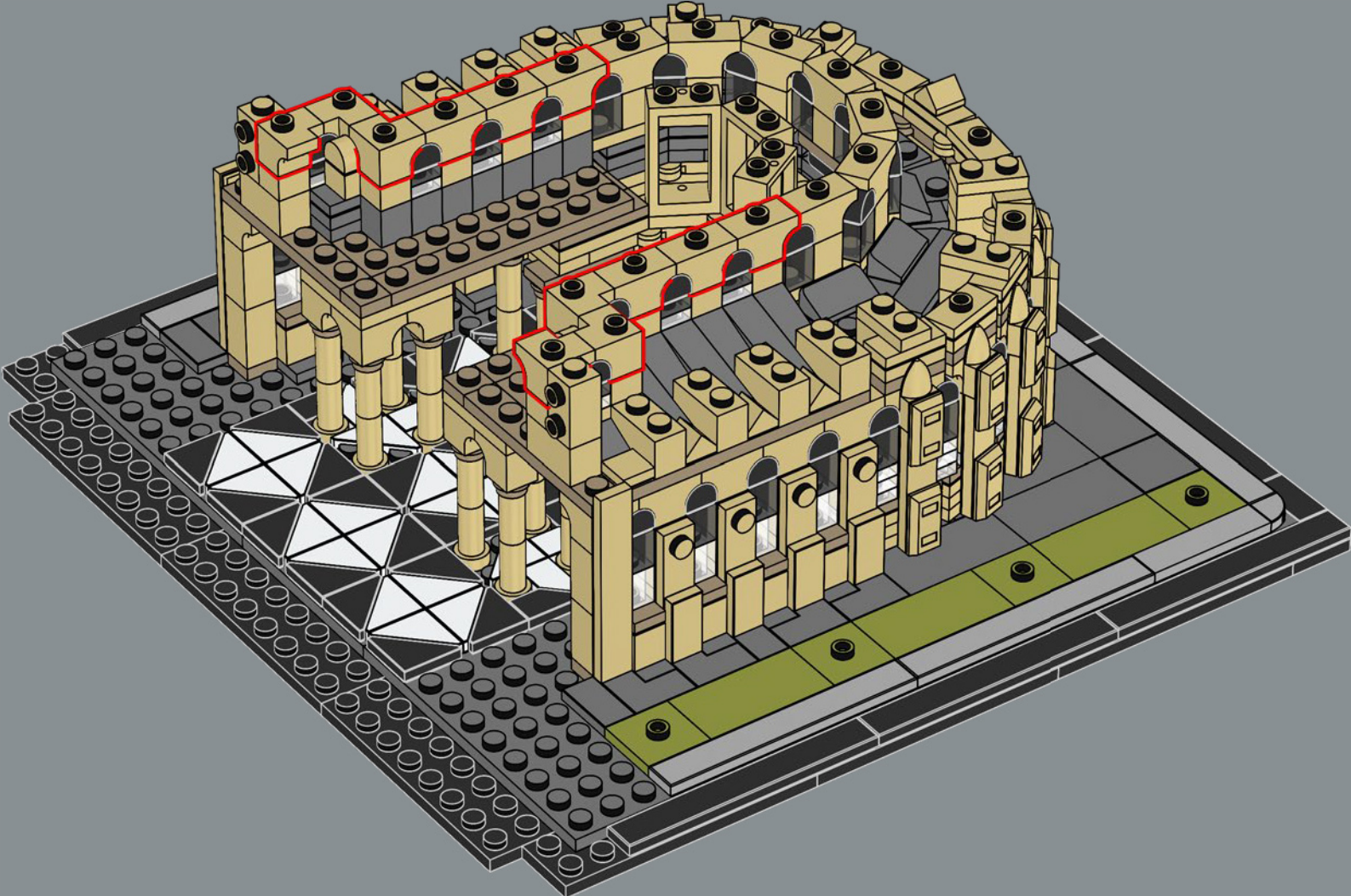

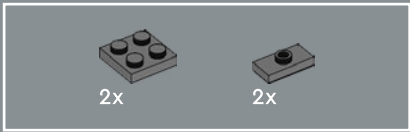

90

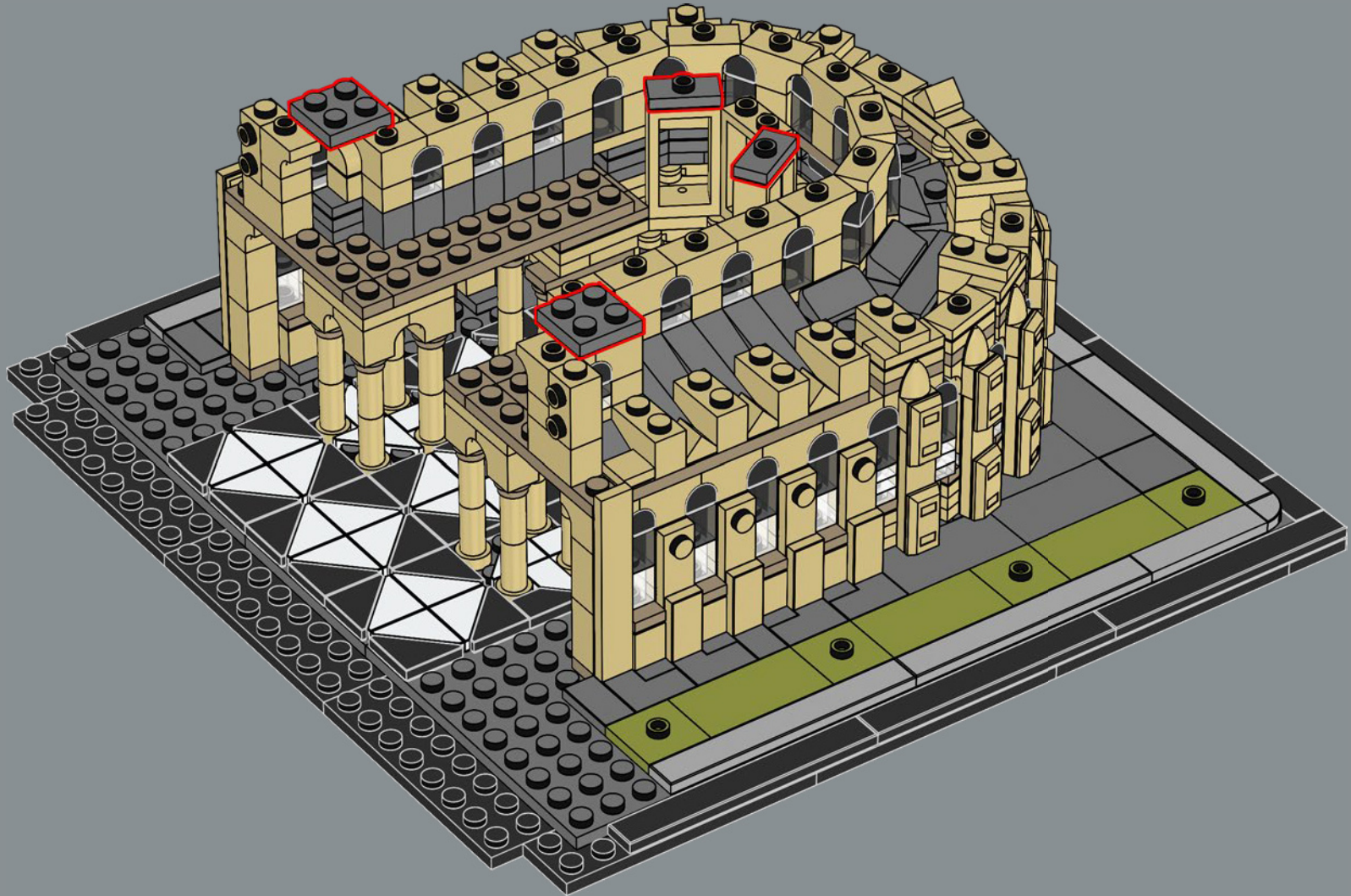



91

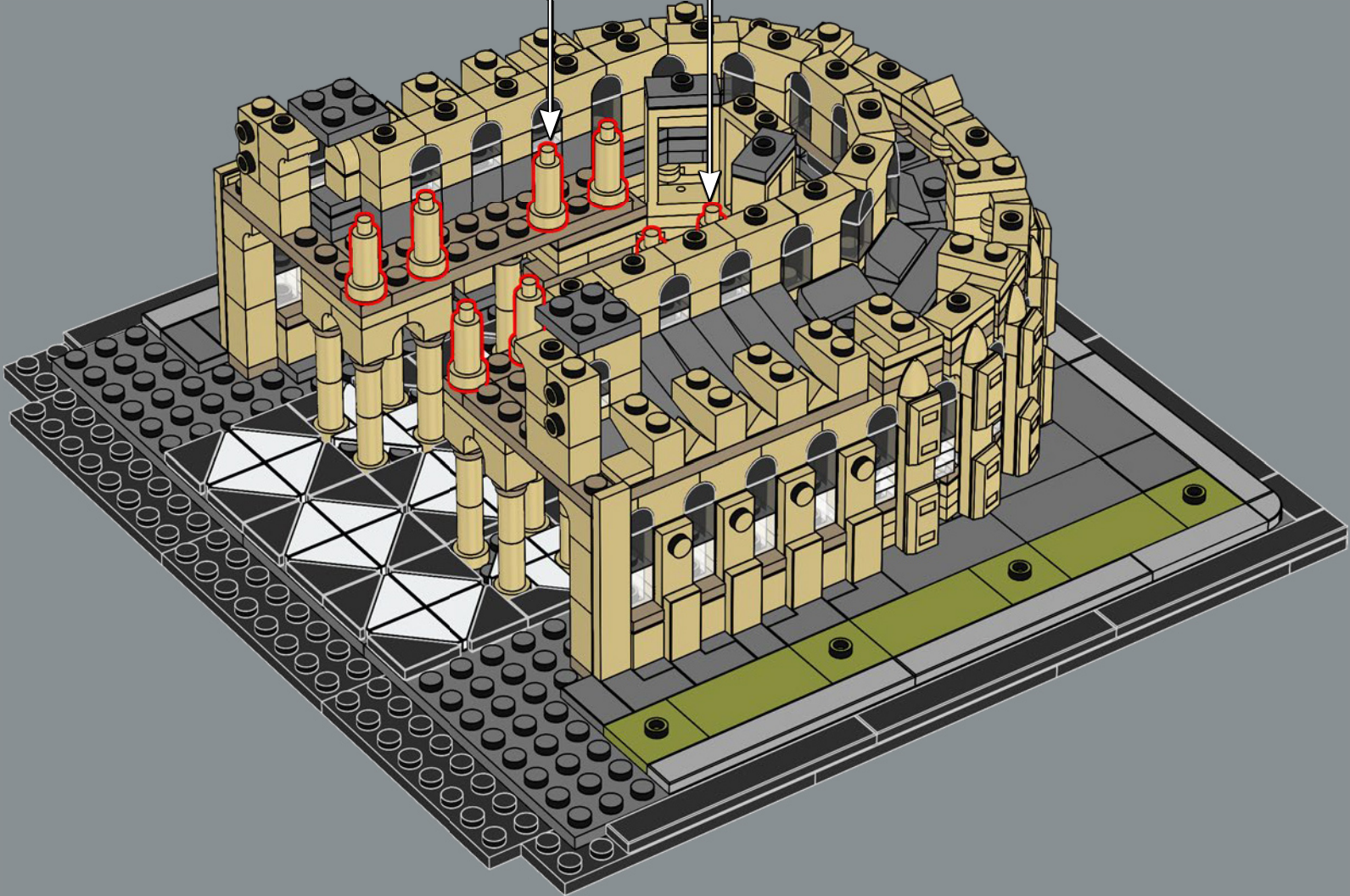
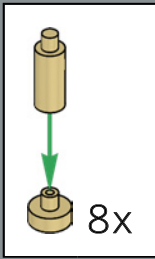

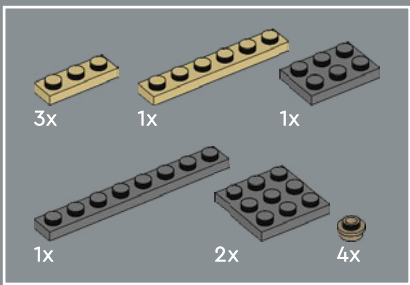

92

1

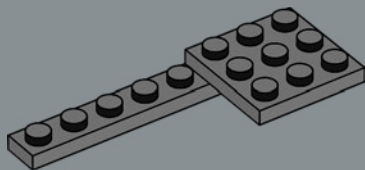

2

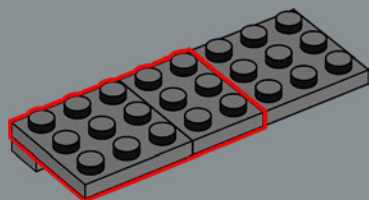

3

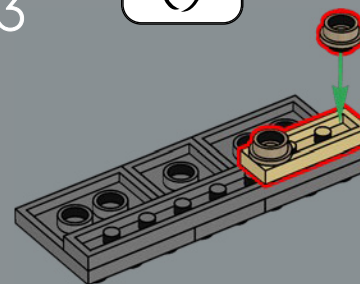

1

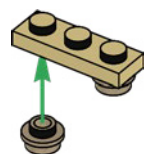

2

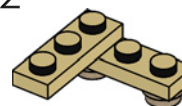

3

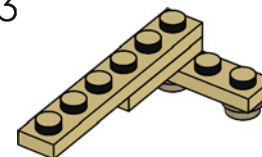

4

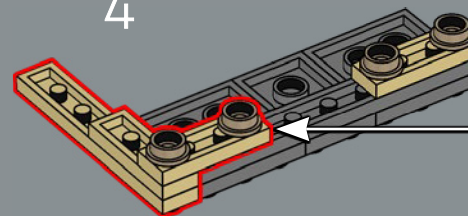

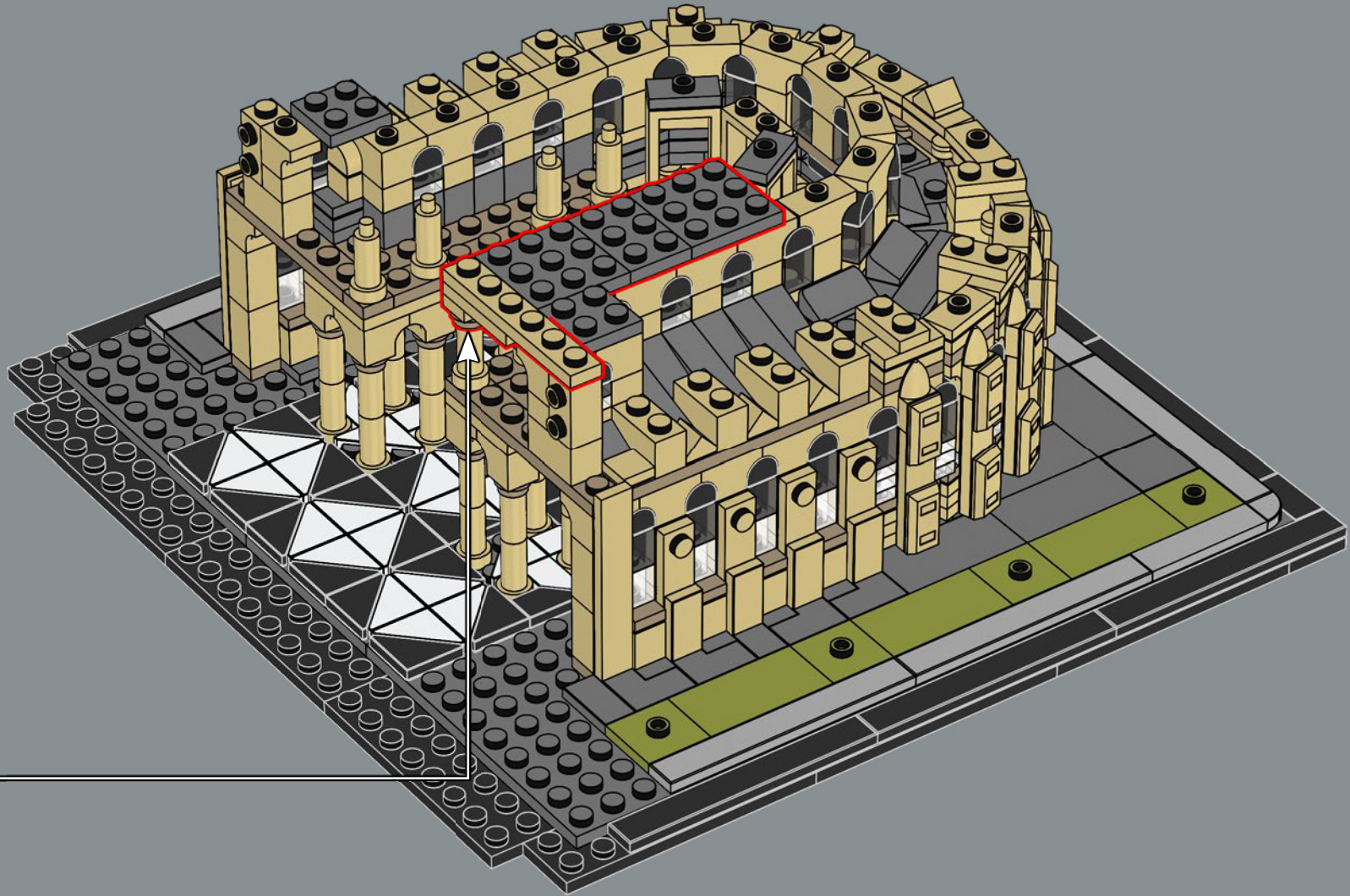

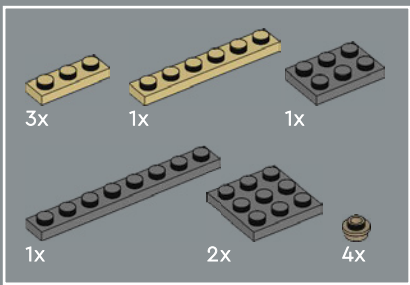

93

1

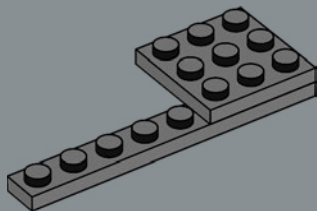

2

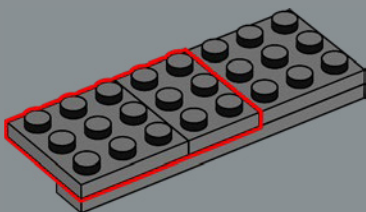

3

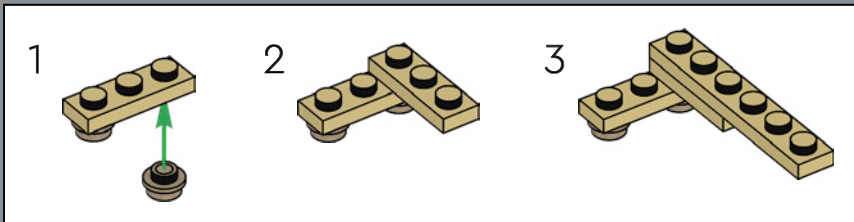
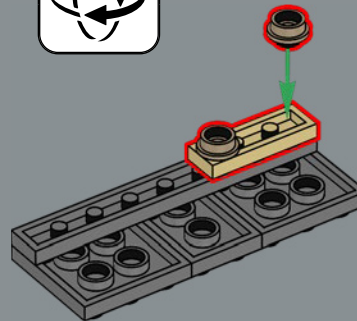

4

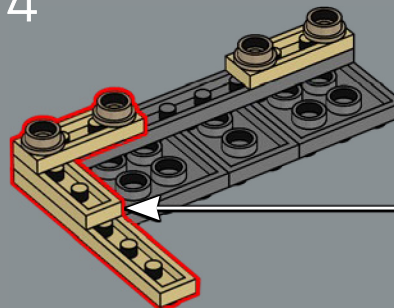

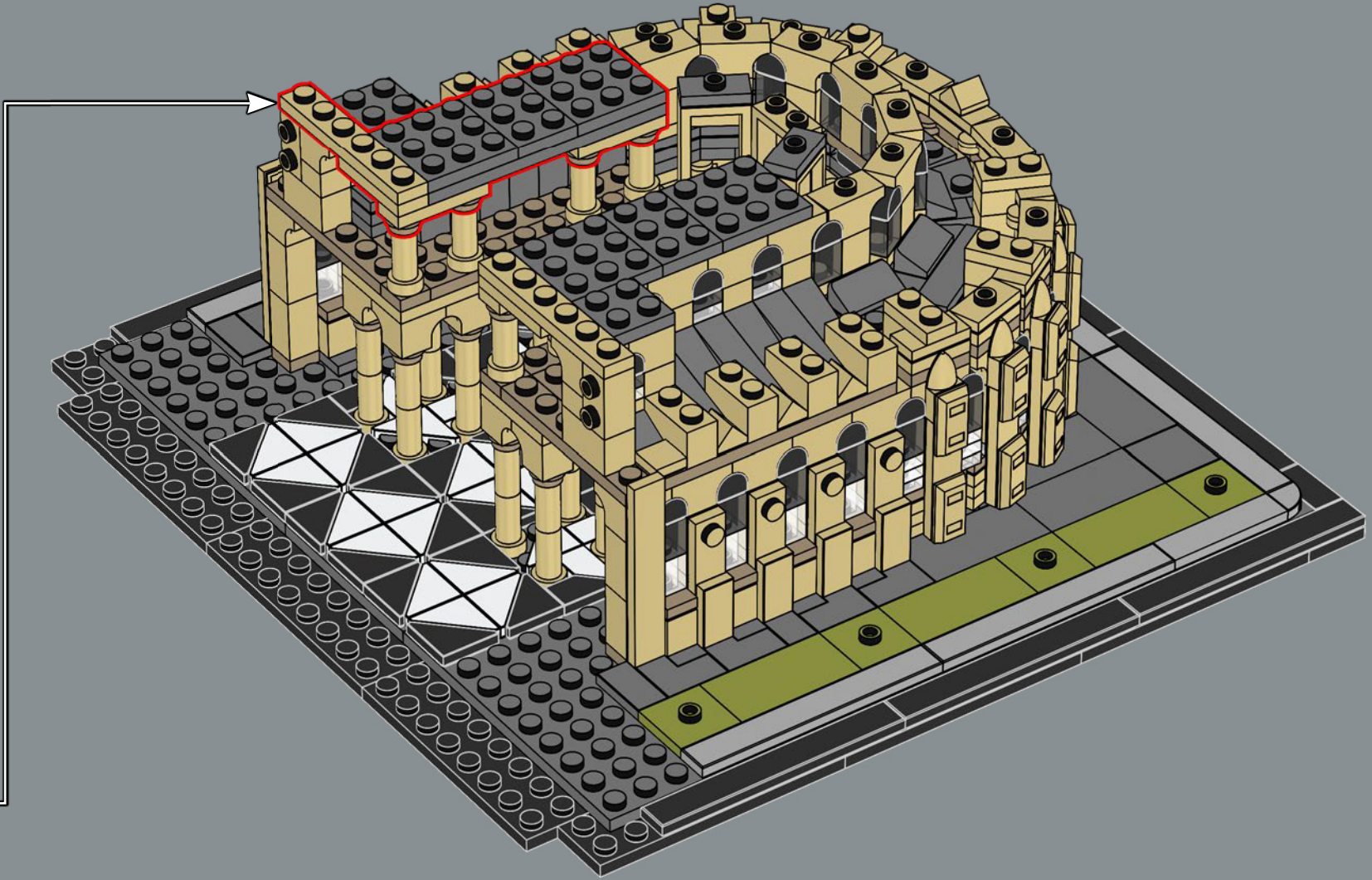



6x

94

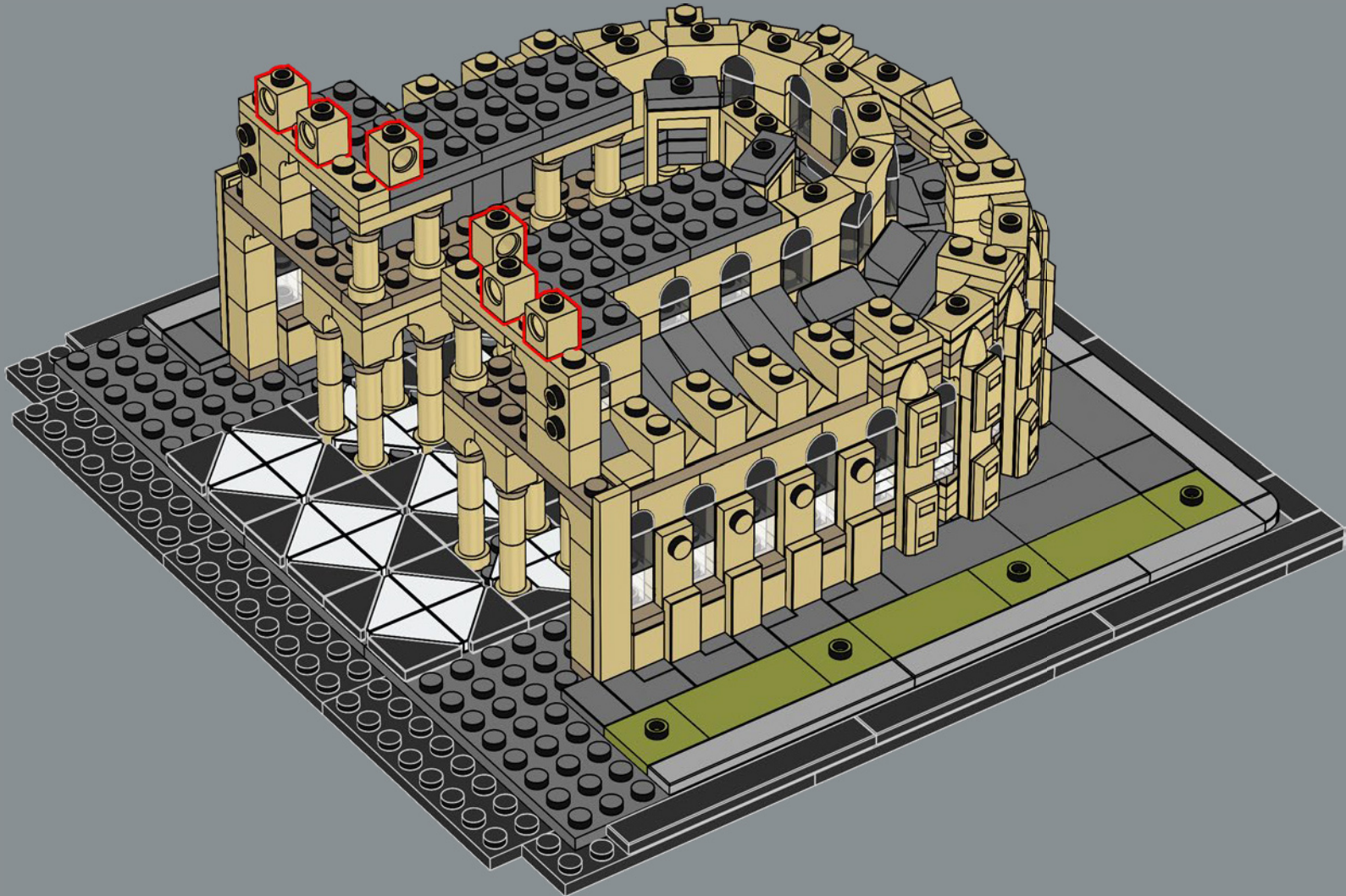

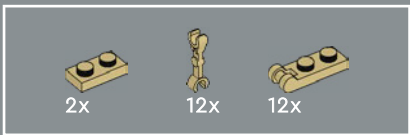

95

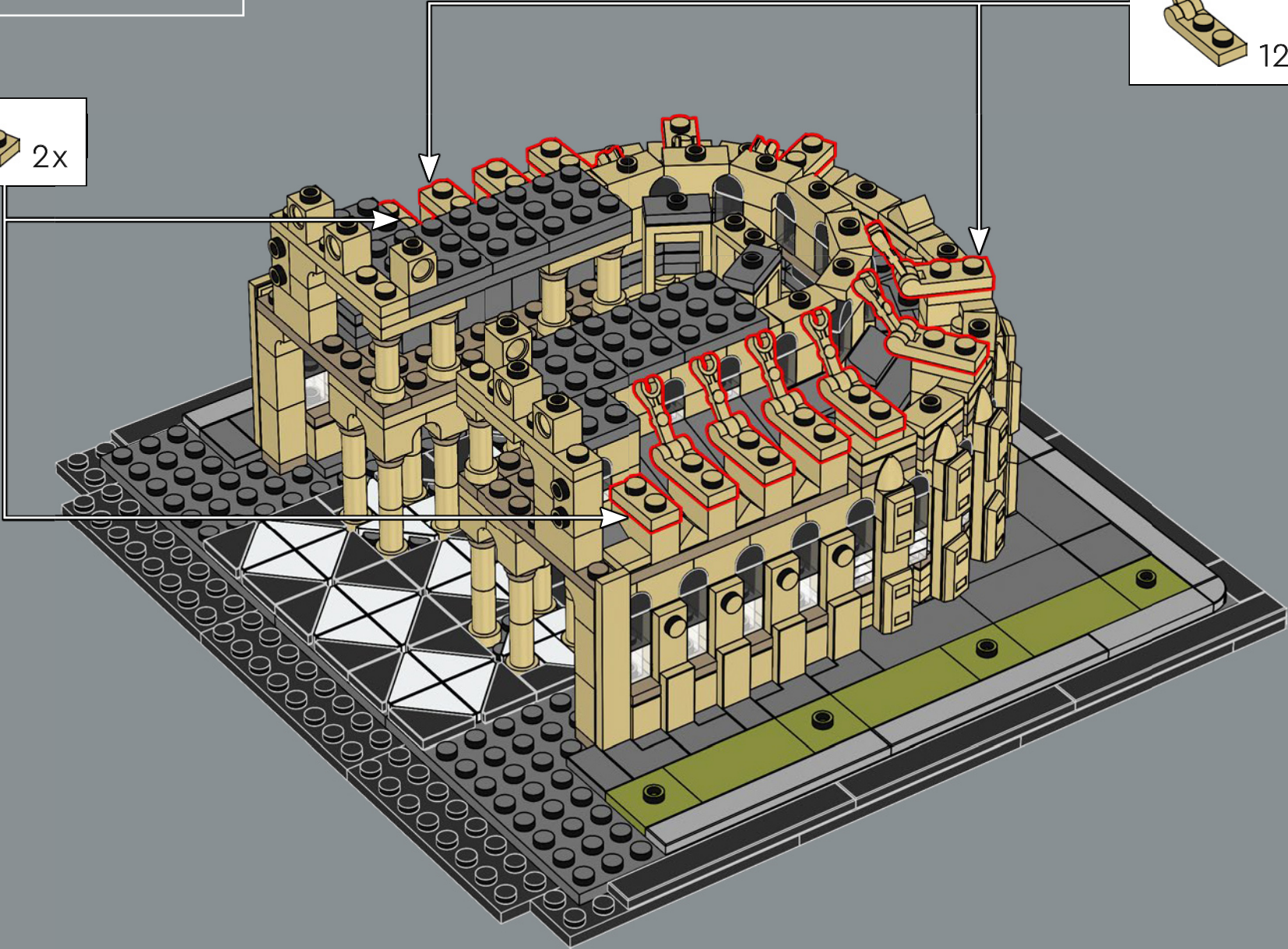
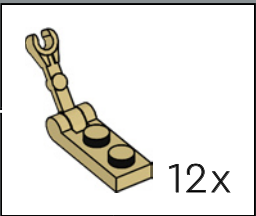
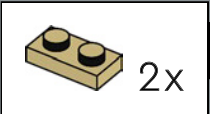

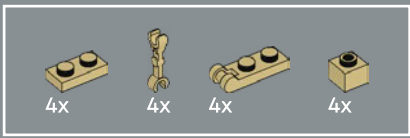

96

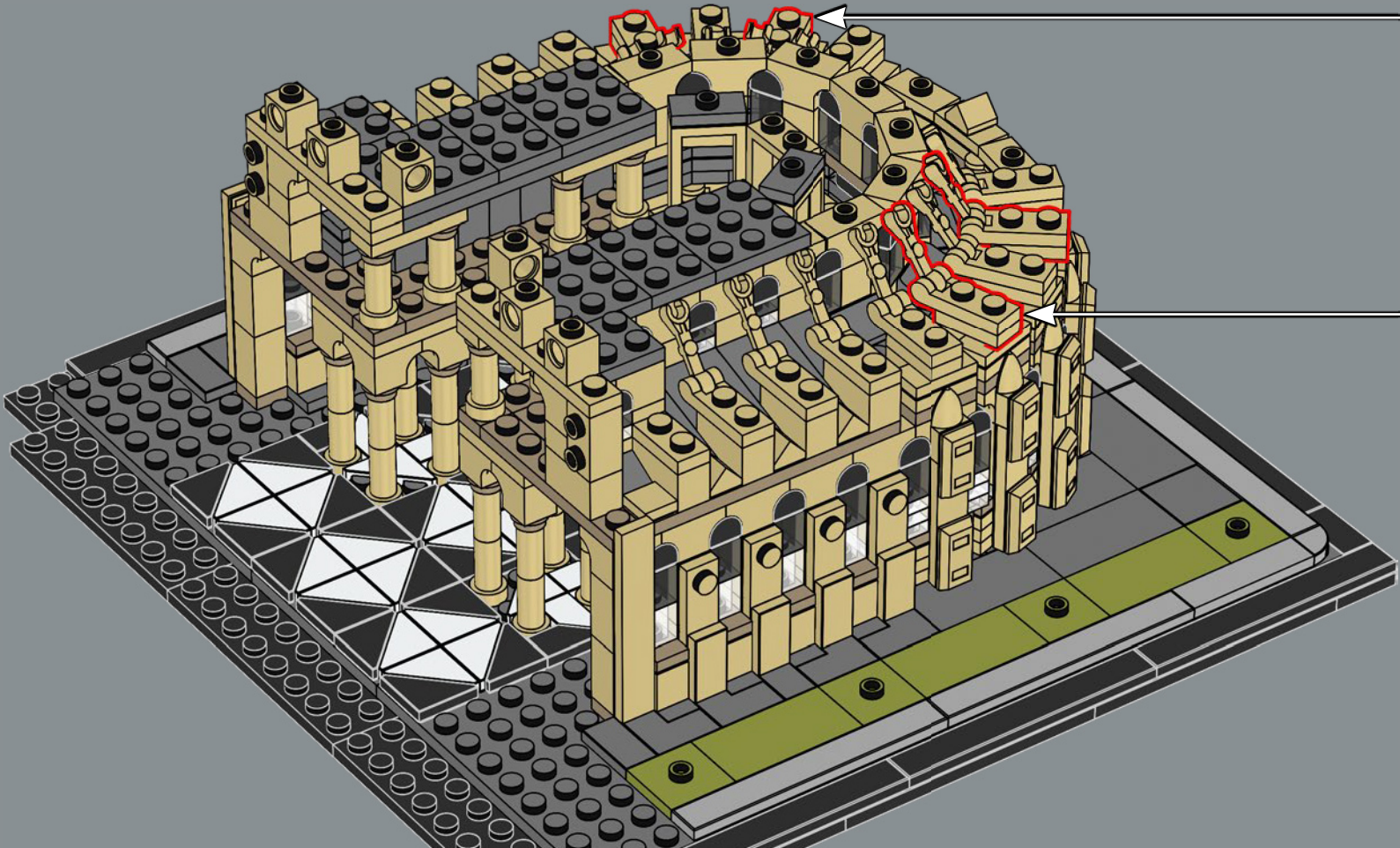
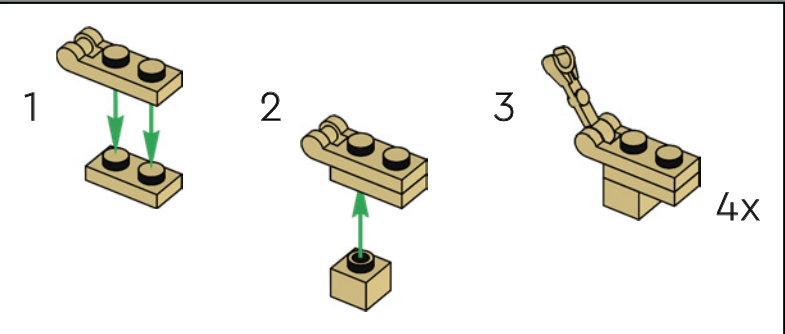

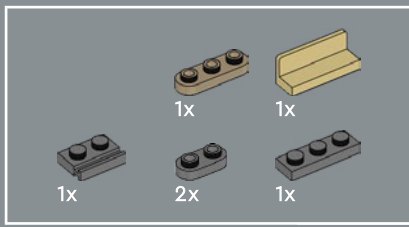

97

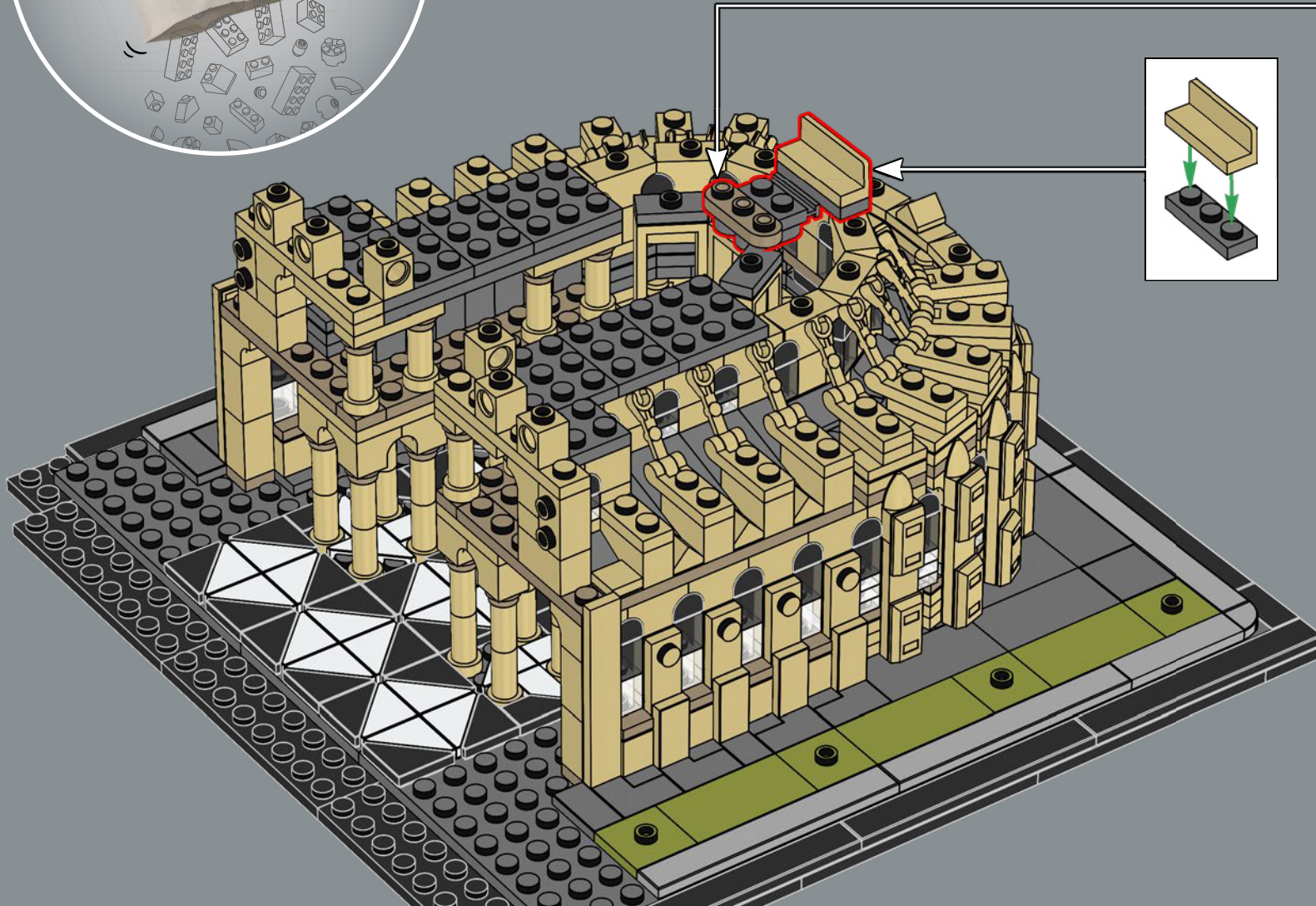
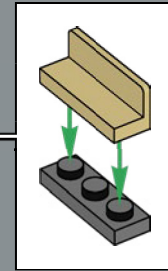
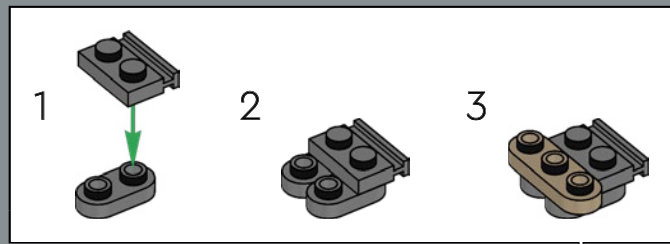



98

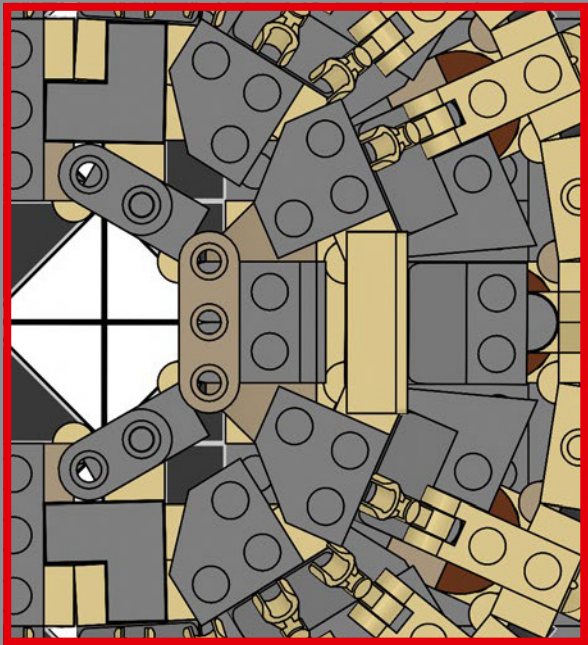
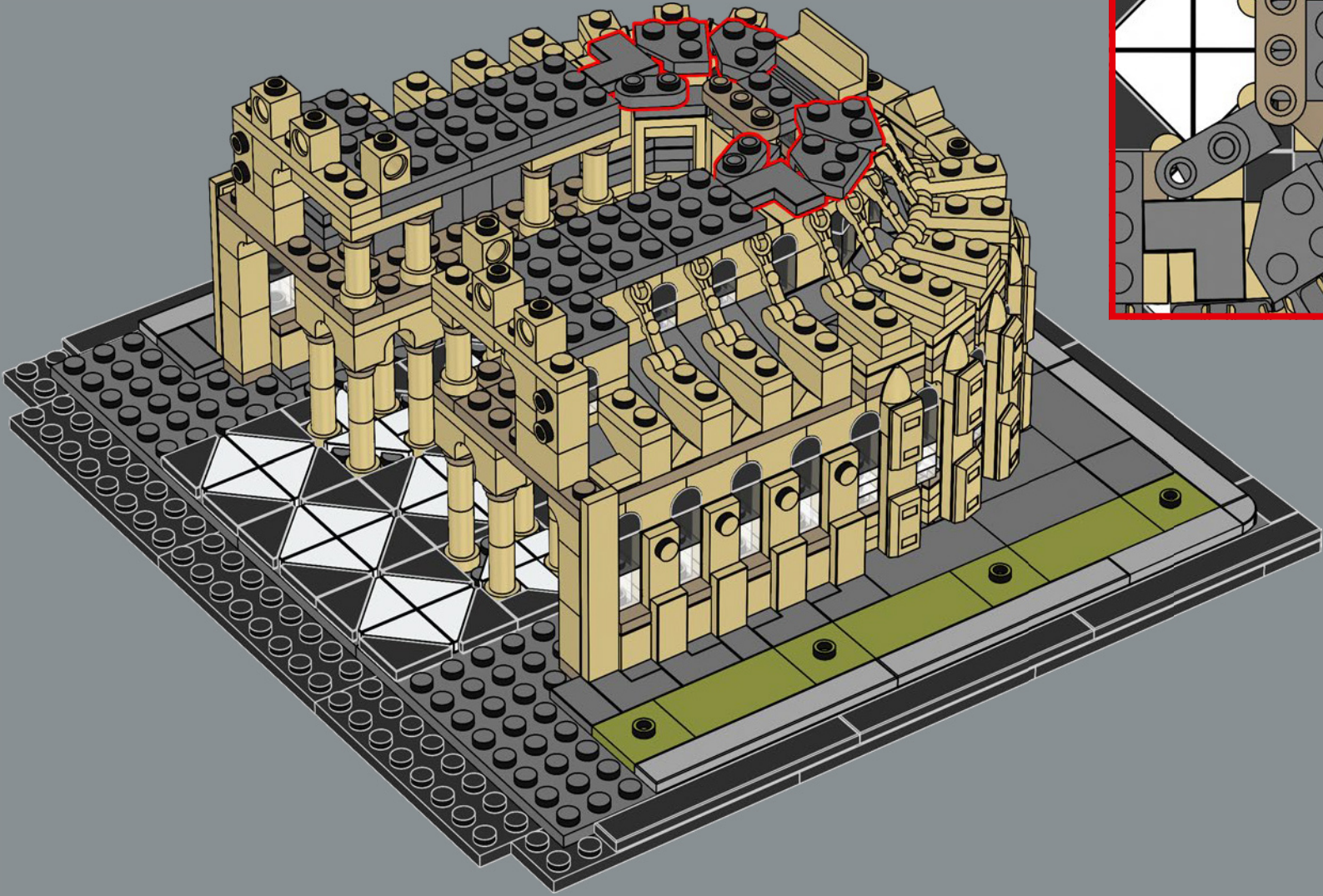



99

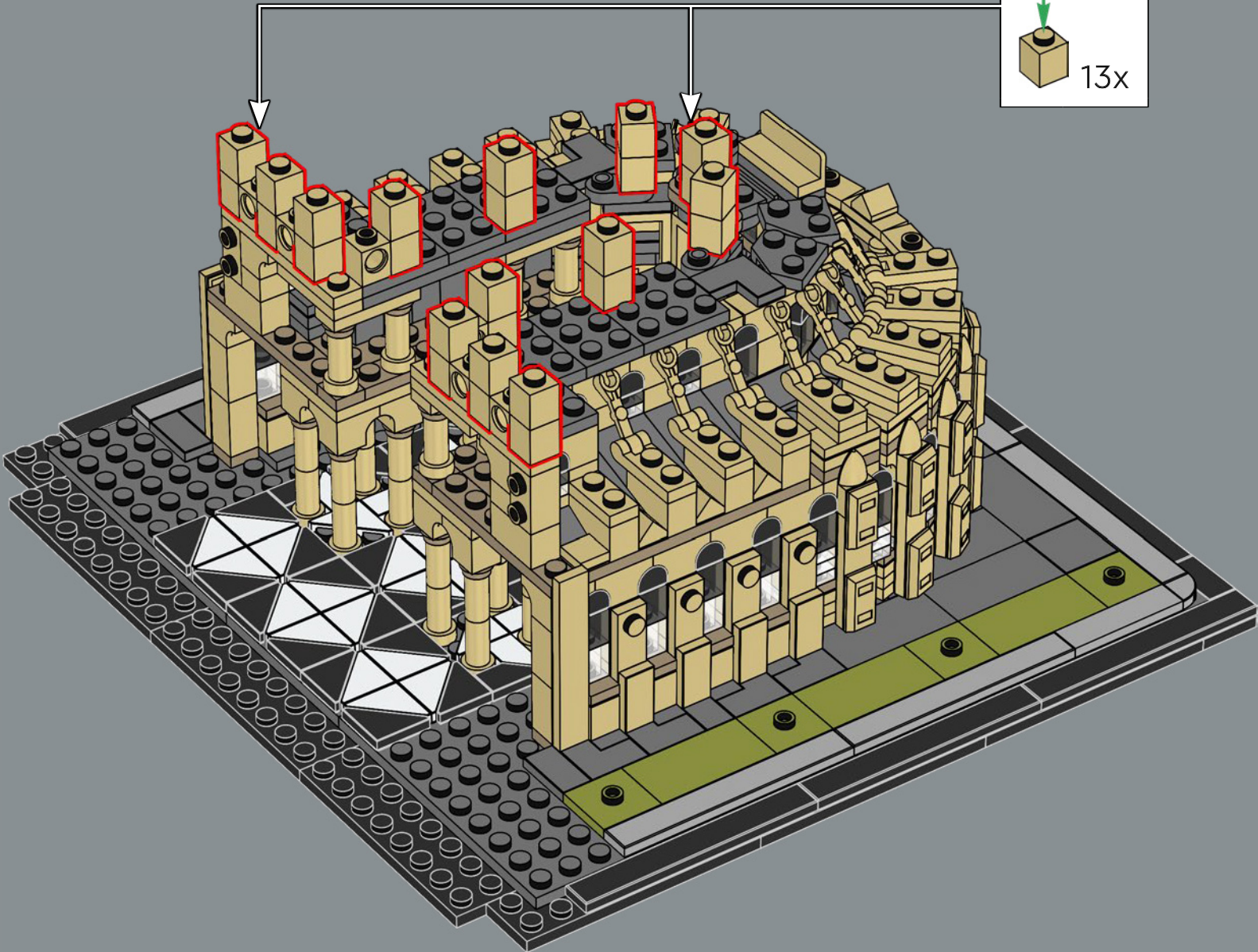
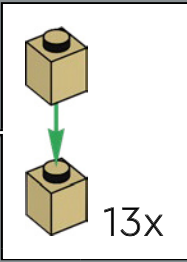

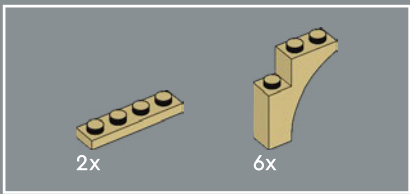

100

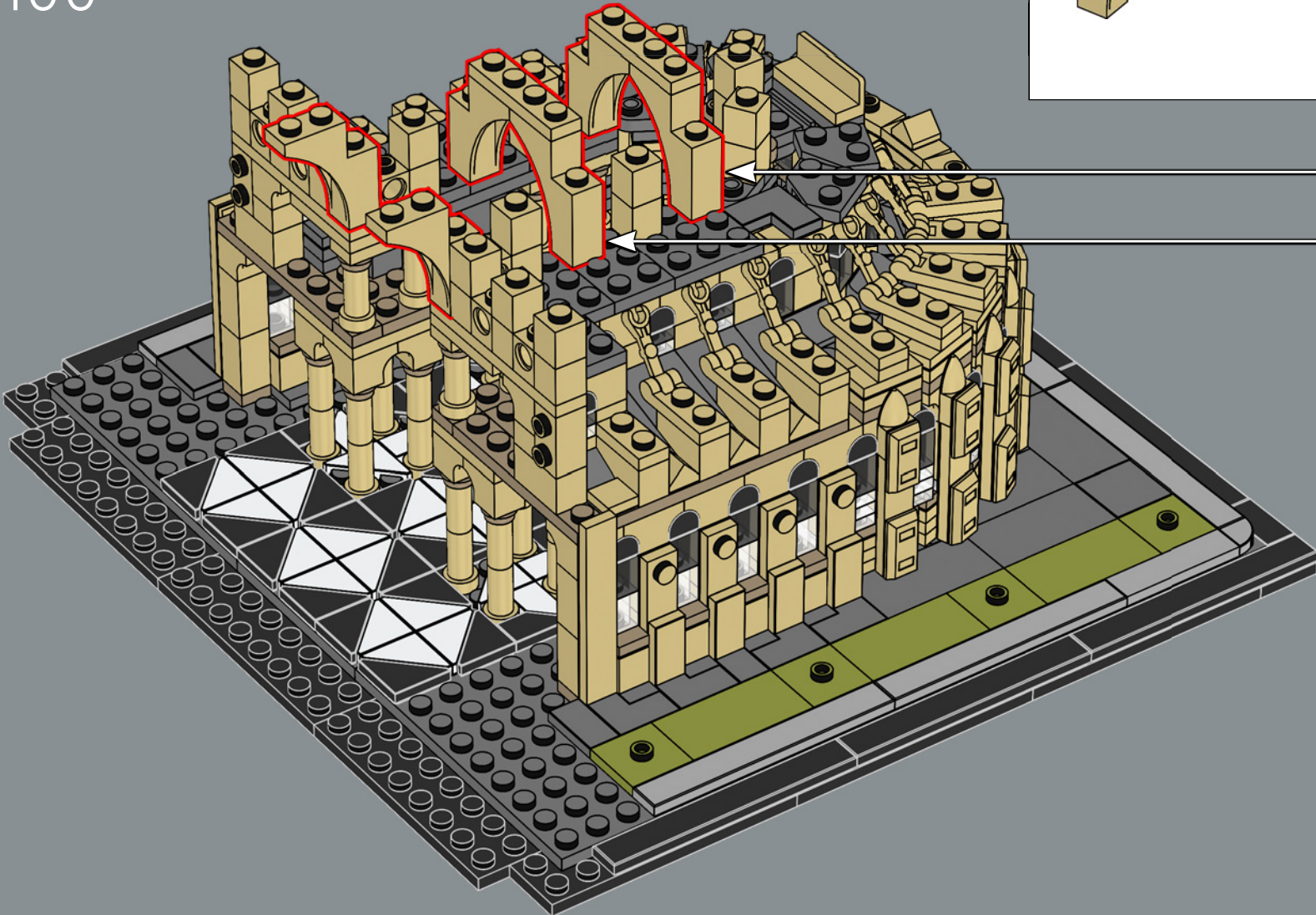
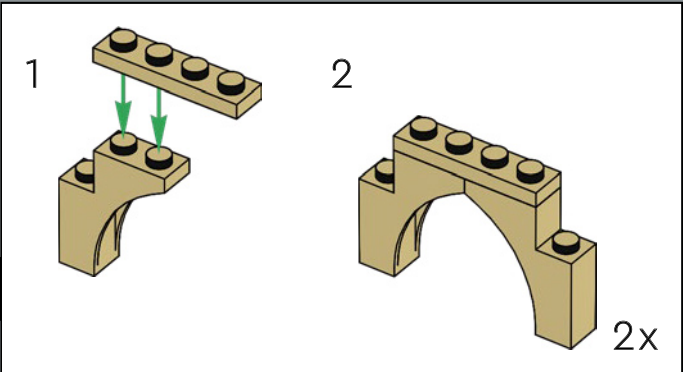

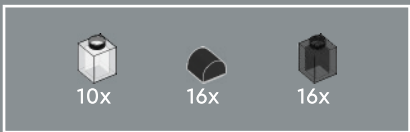

101

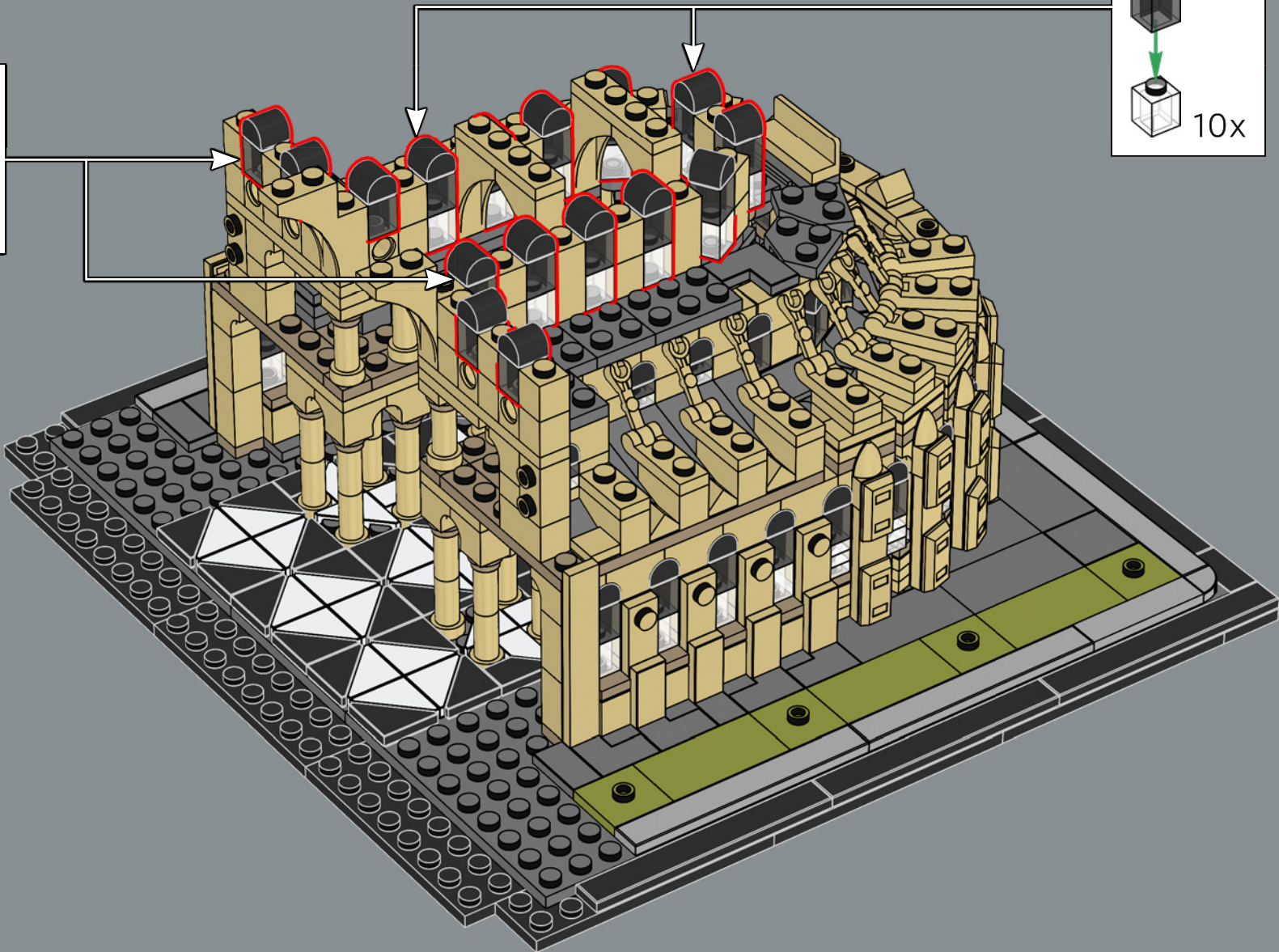
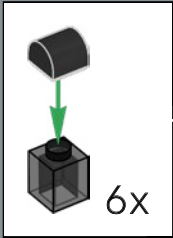

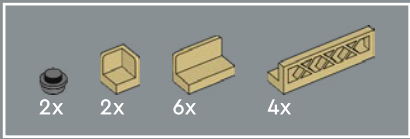

102

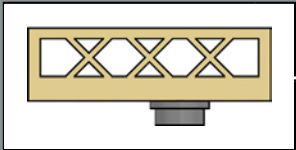
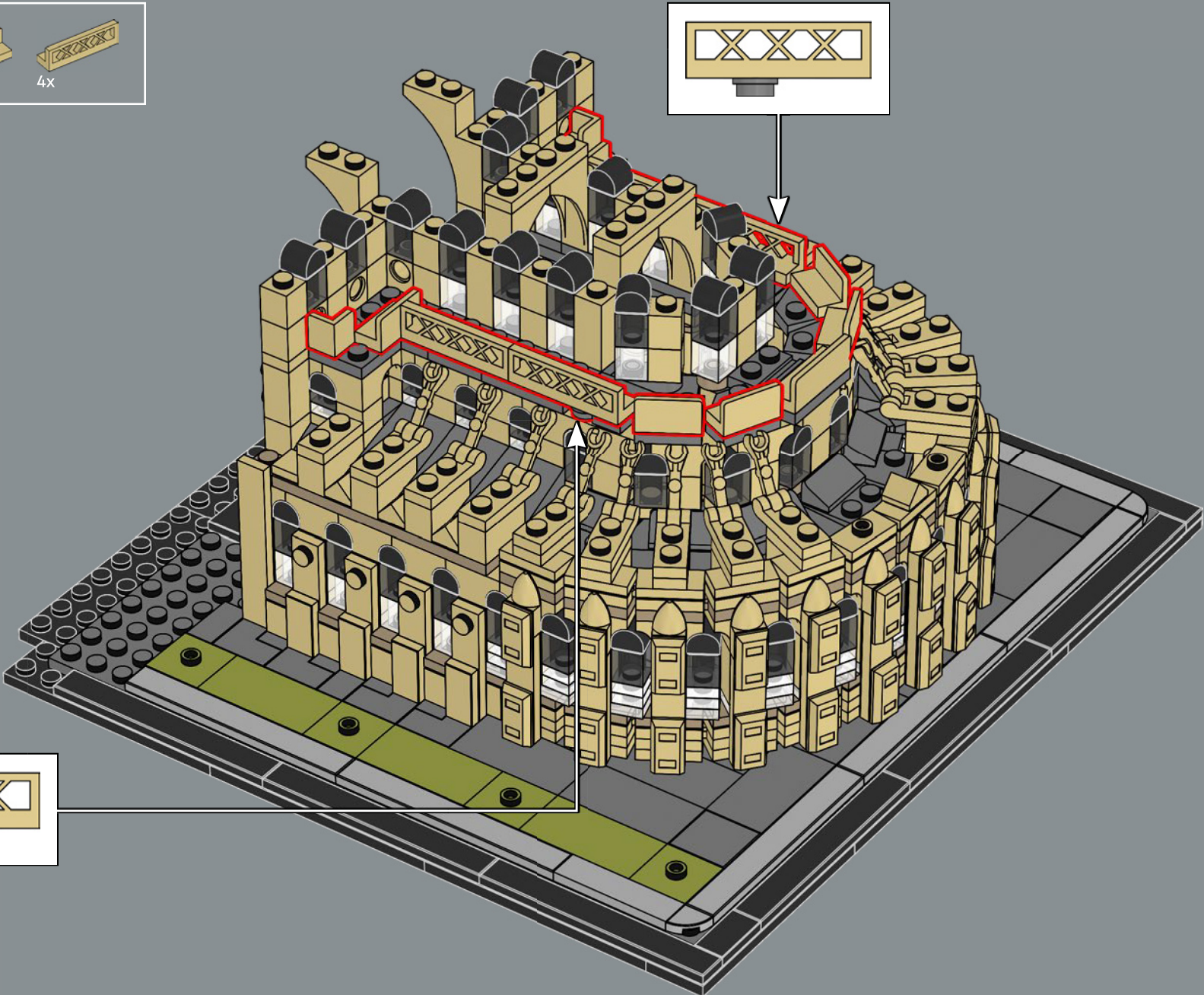

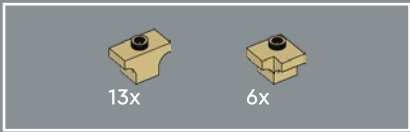

103

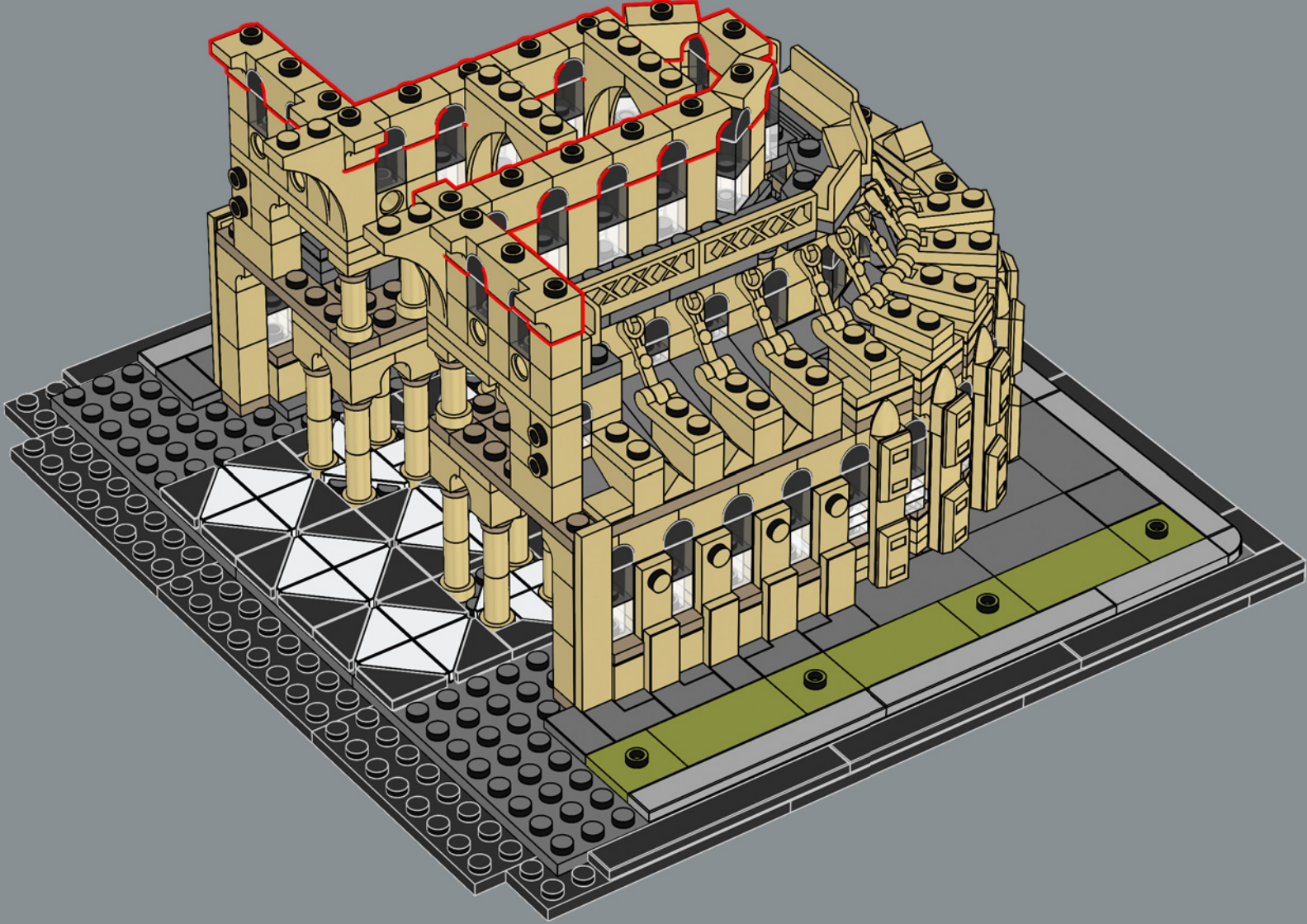

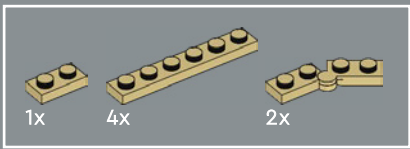

104

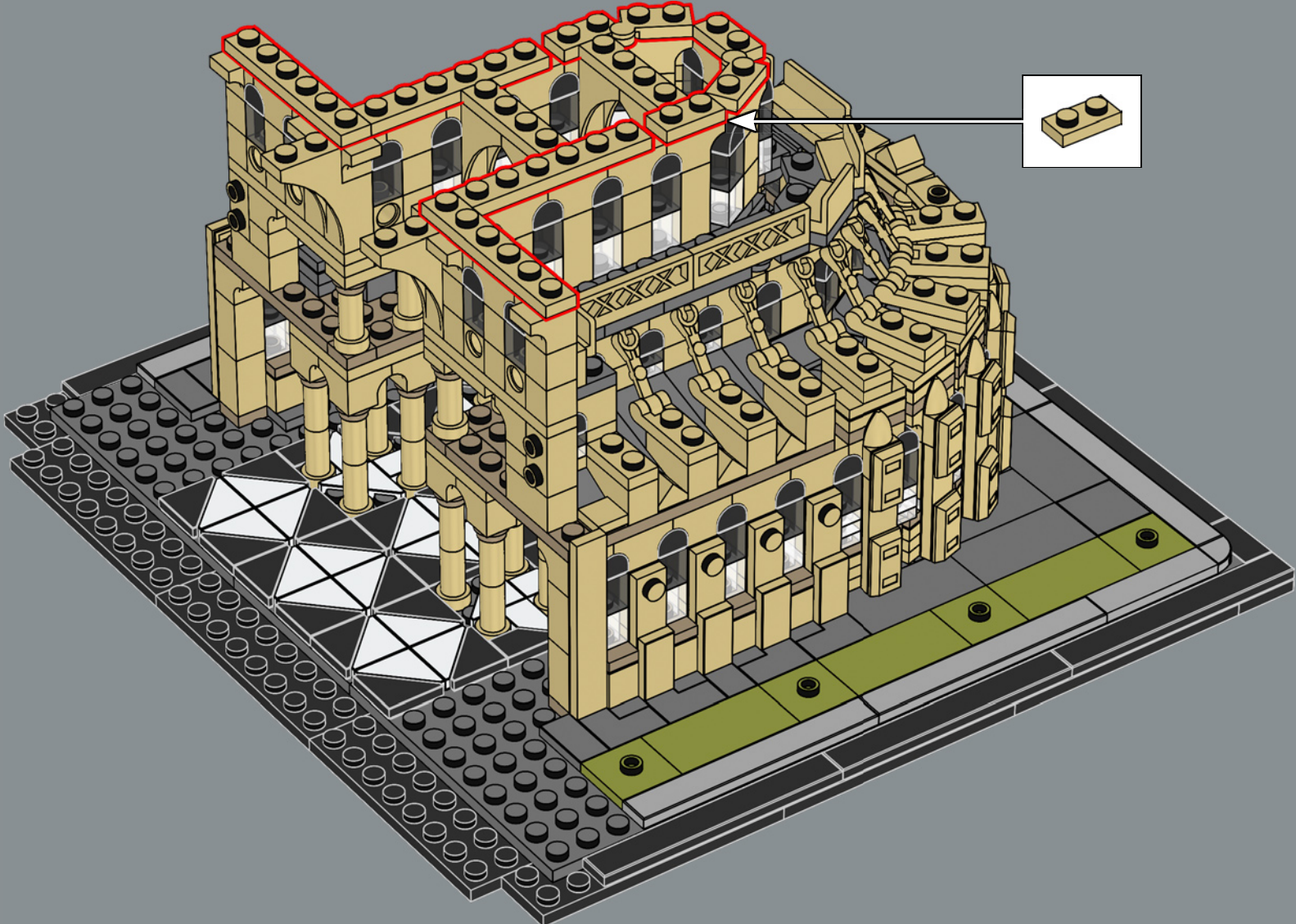

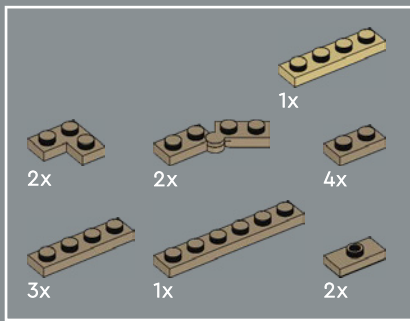

105

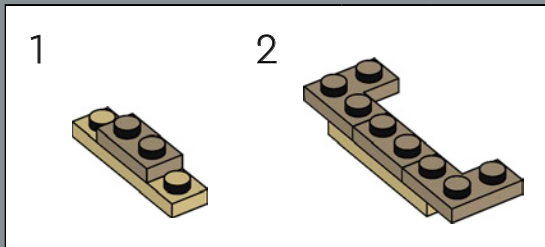
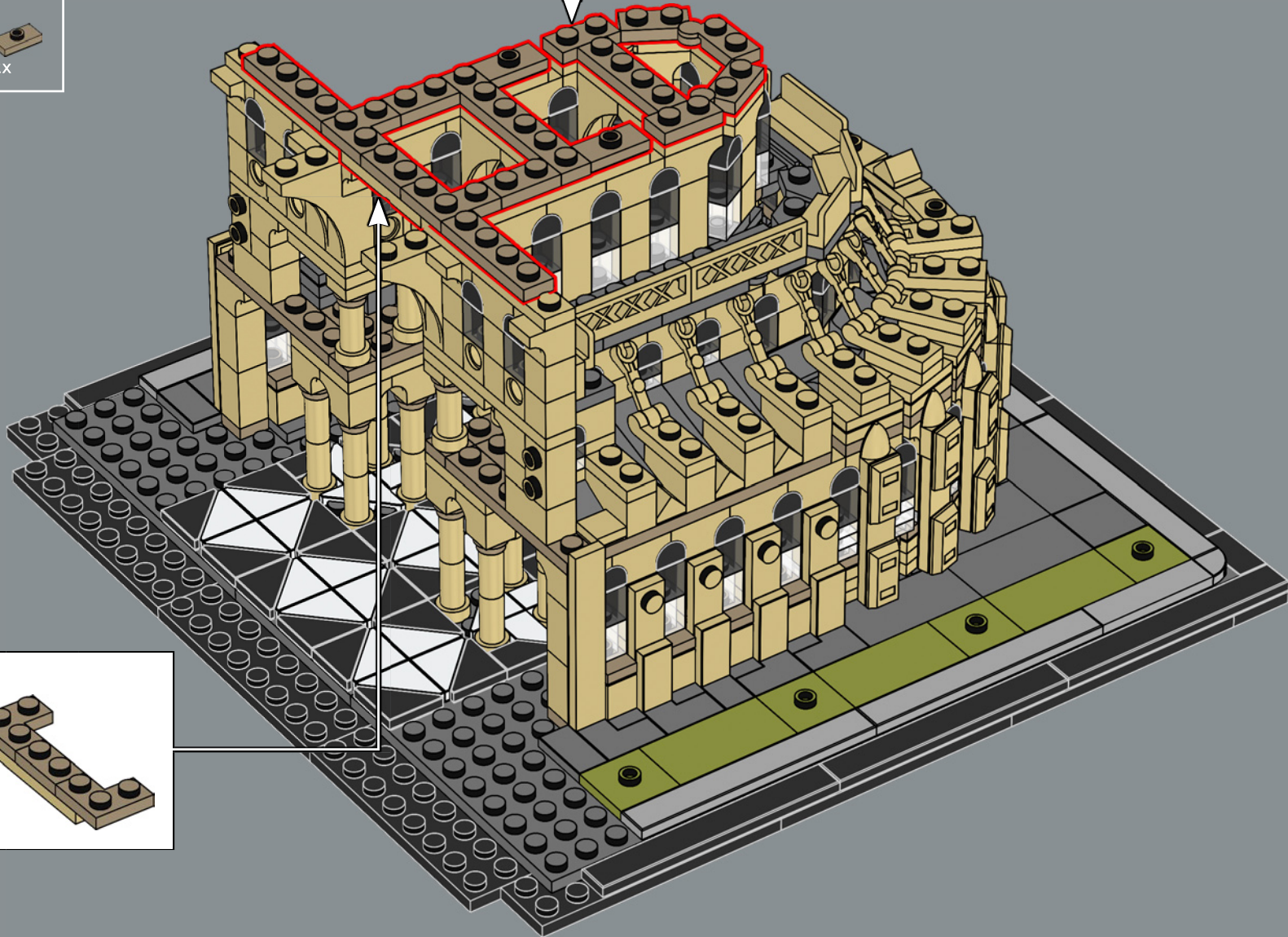
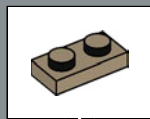

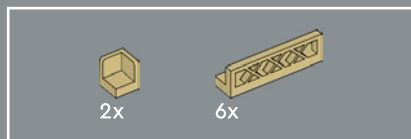

106

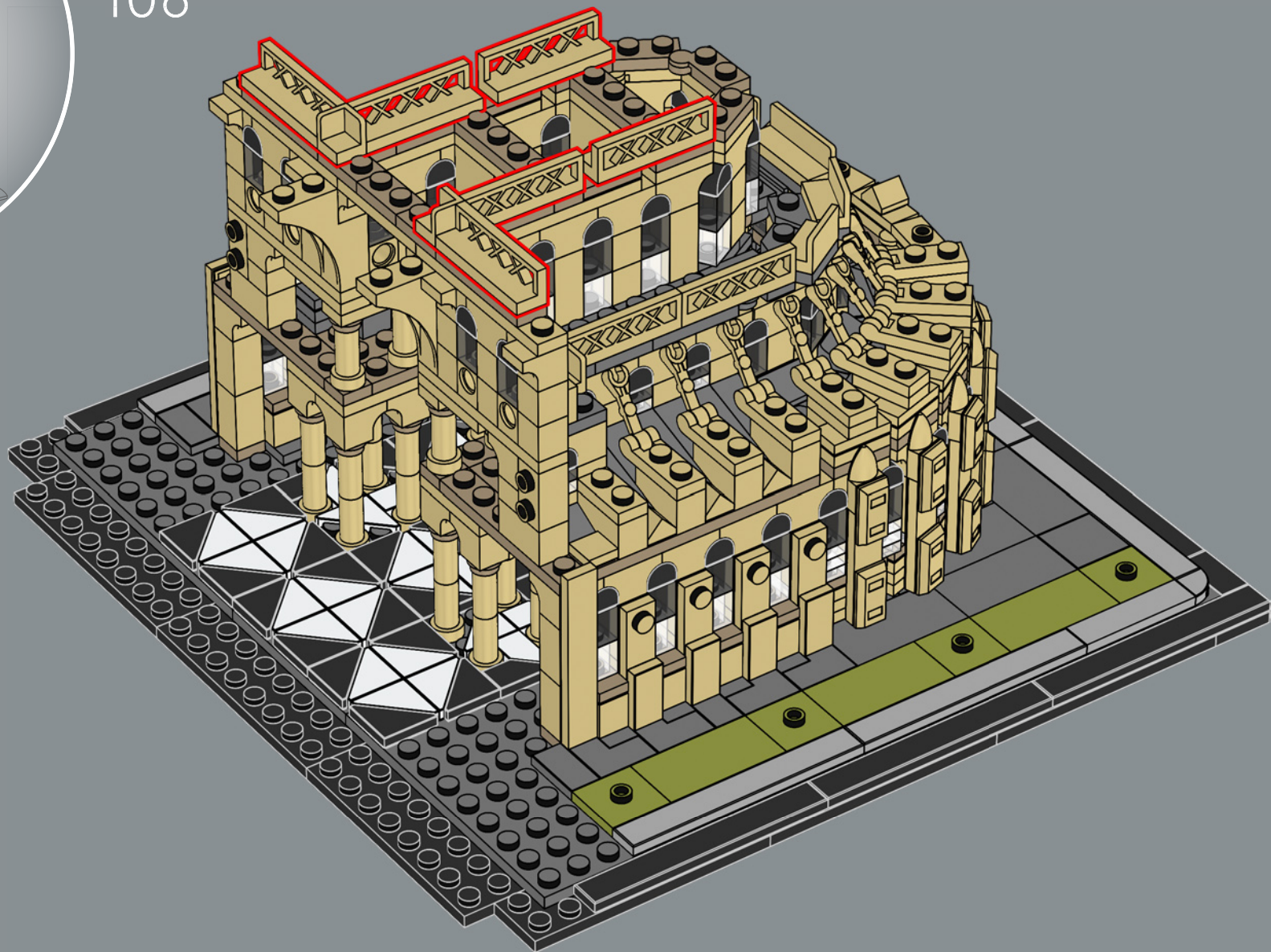

6x 10x

4x

6x

107

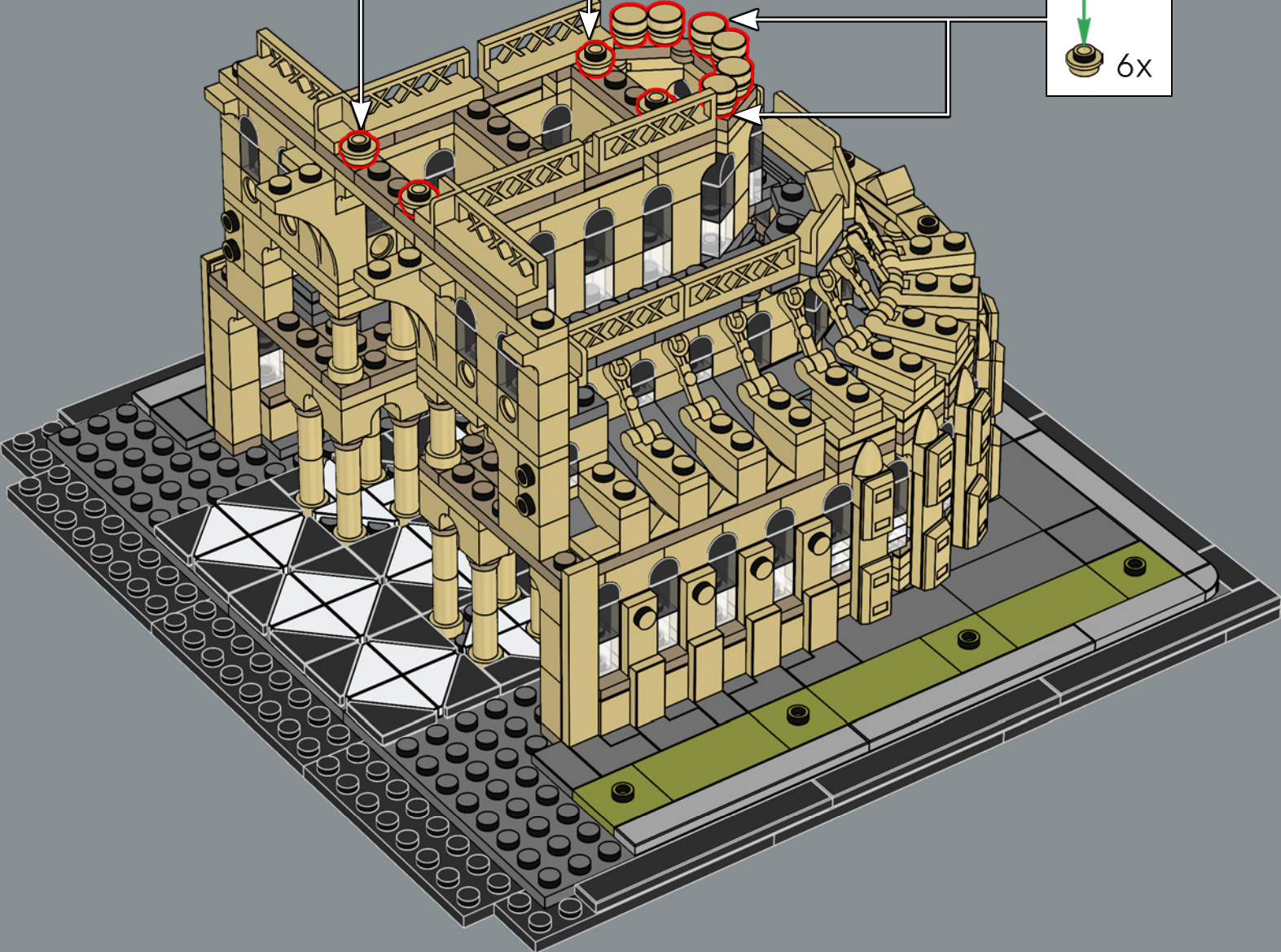

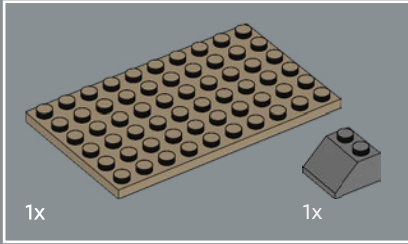
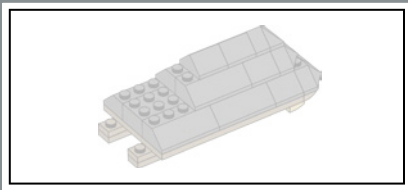

108

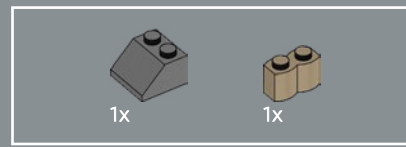
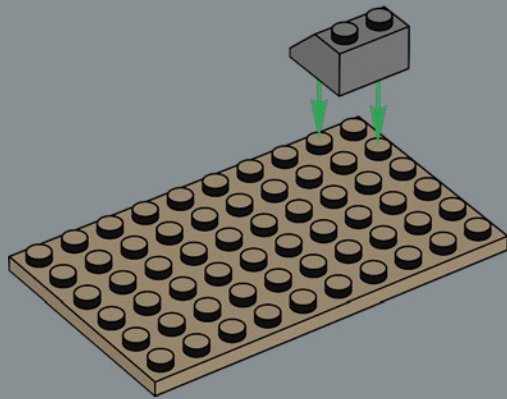

109

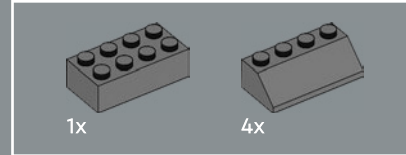
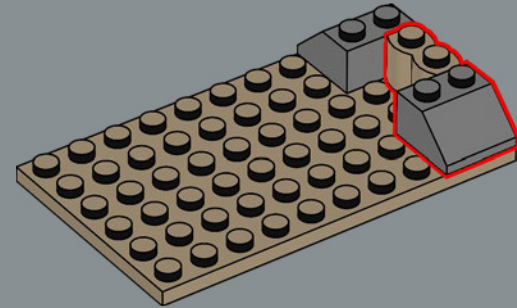

110

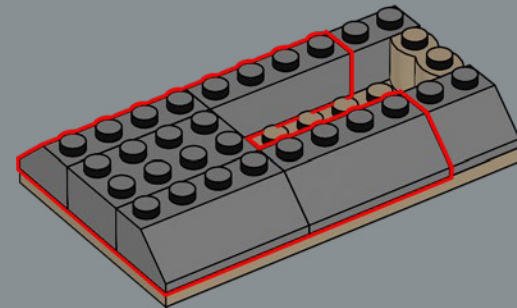

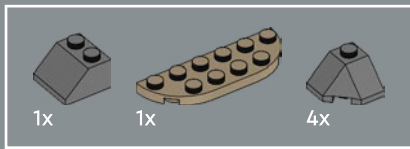

111

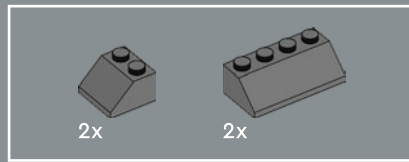
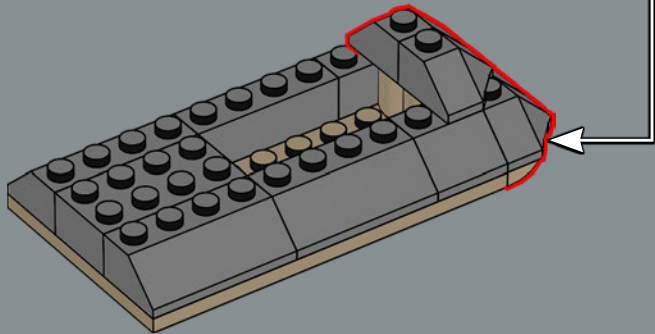

112

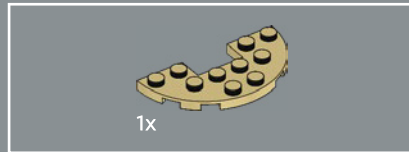
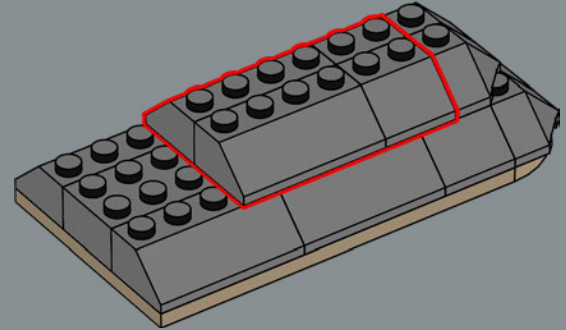

113

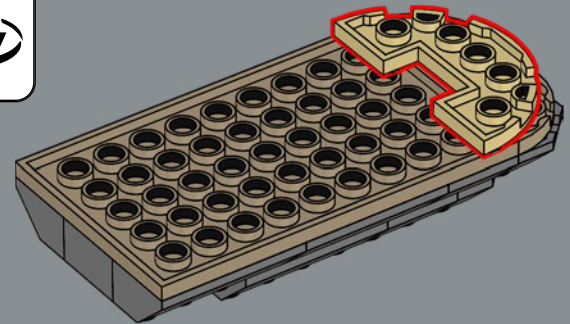

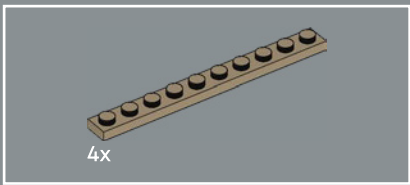

114

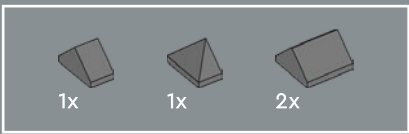
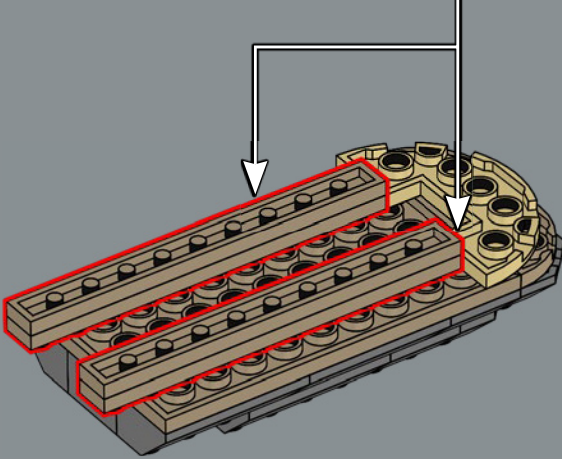
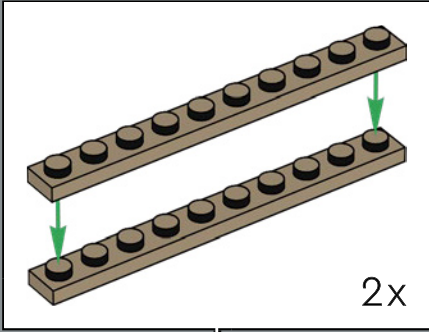

115

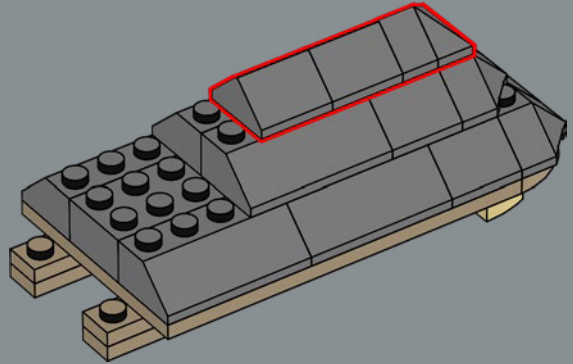

116

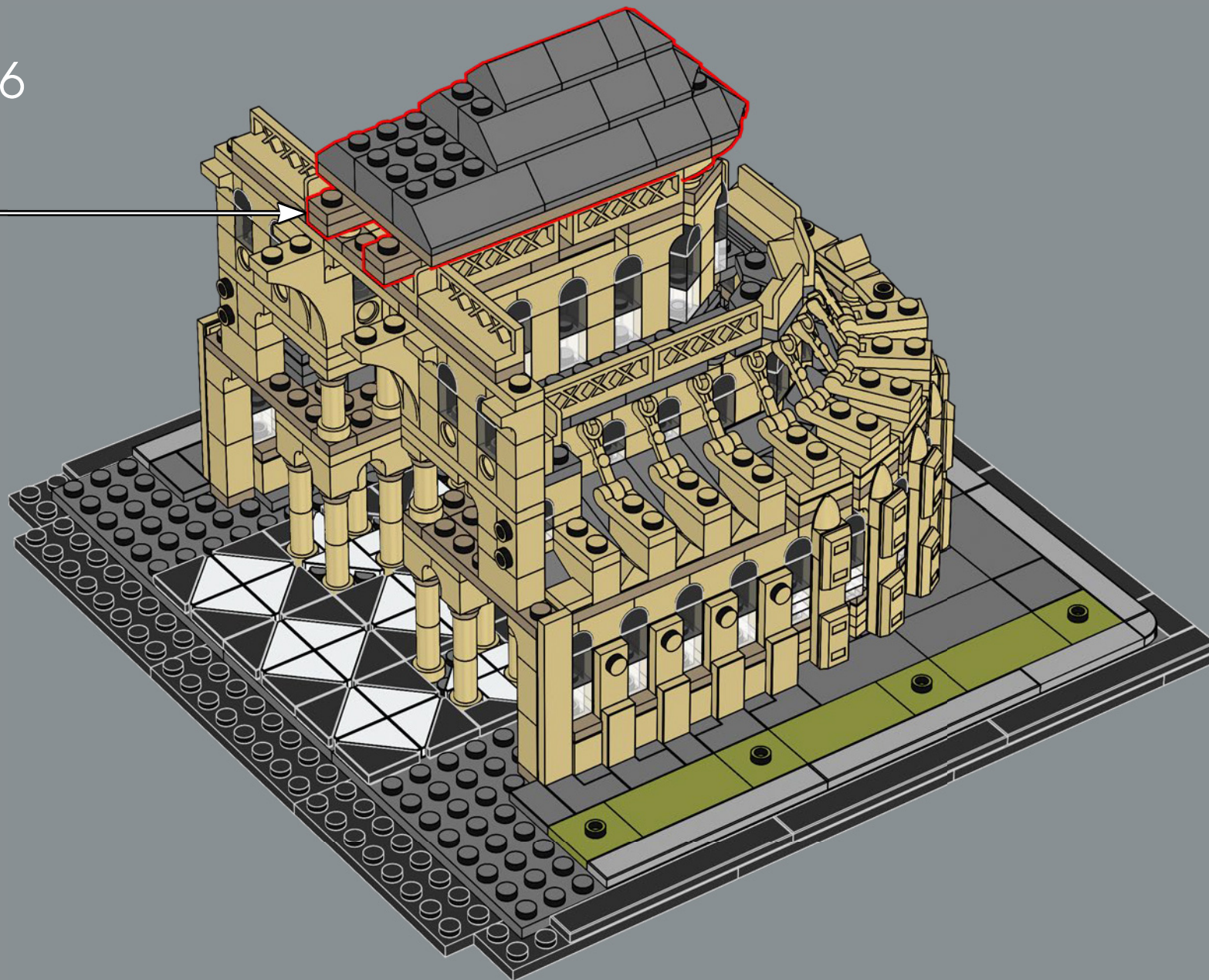

1177: El coro y el ábside están casi terminados, a excepción de las bóvedas altas. Se construyen un tejado y un entramado de madera antes que las bóvedas como medida de protección.

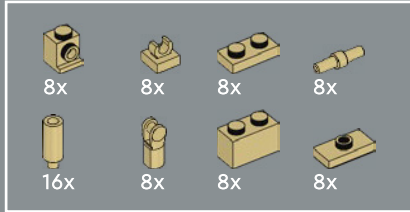
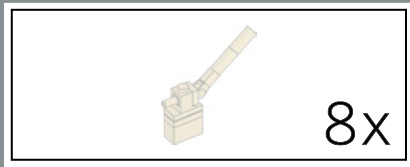

117

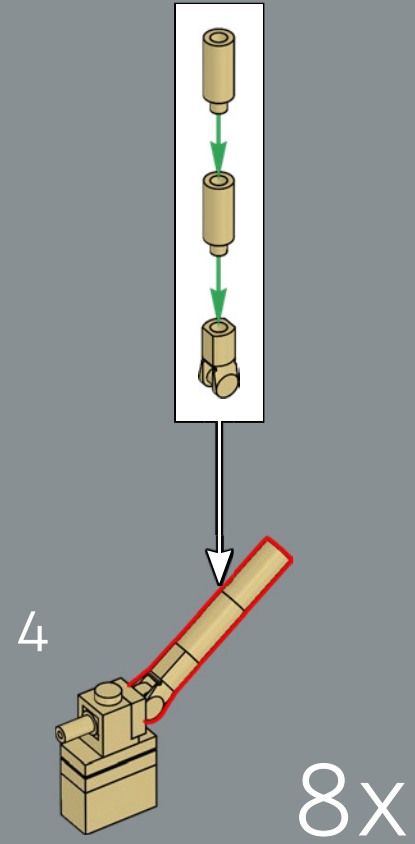
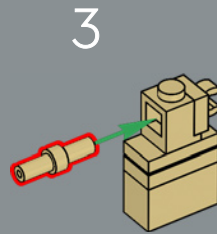
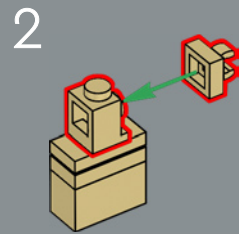
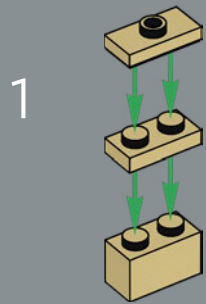

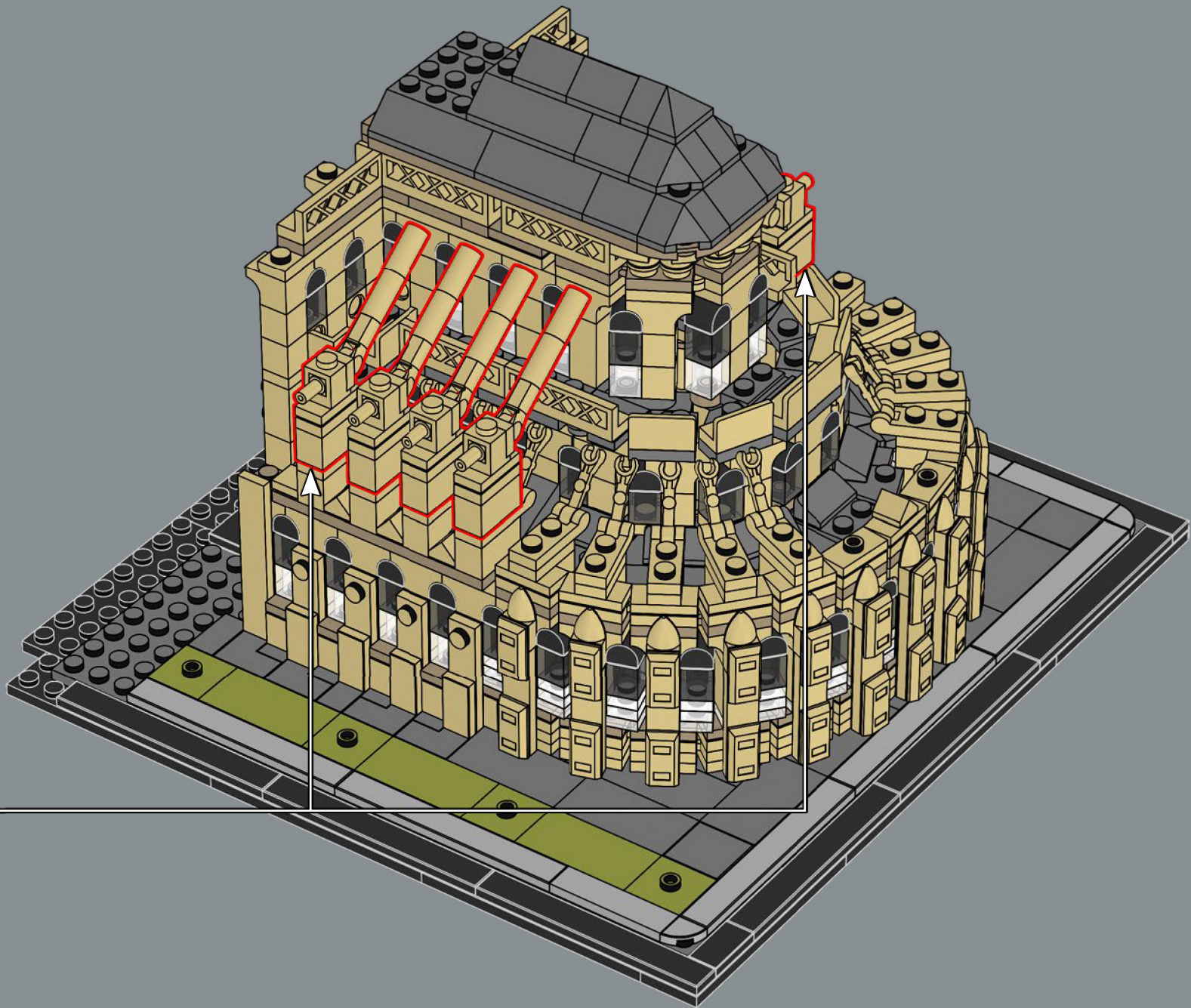

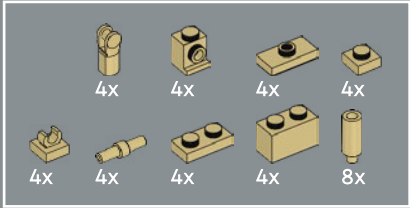
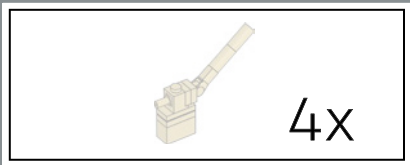

118

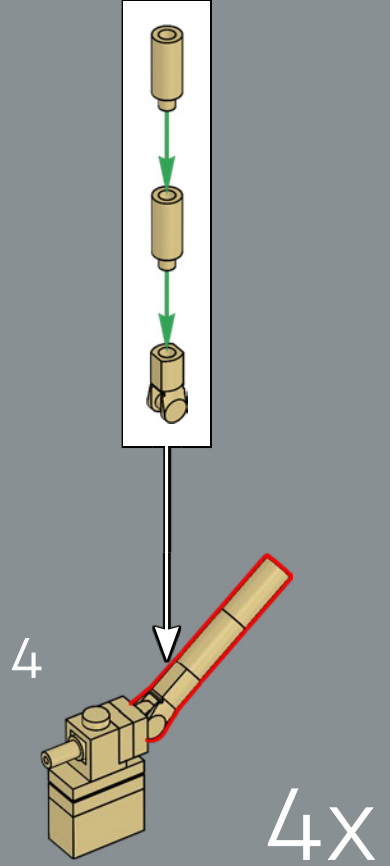
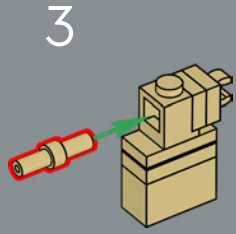
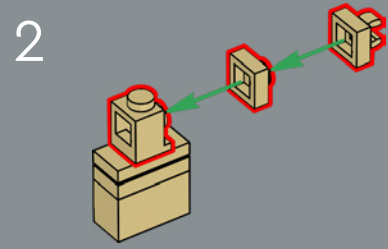
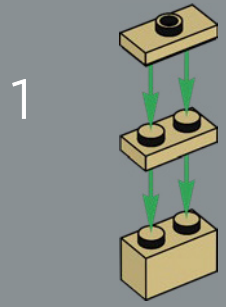

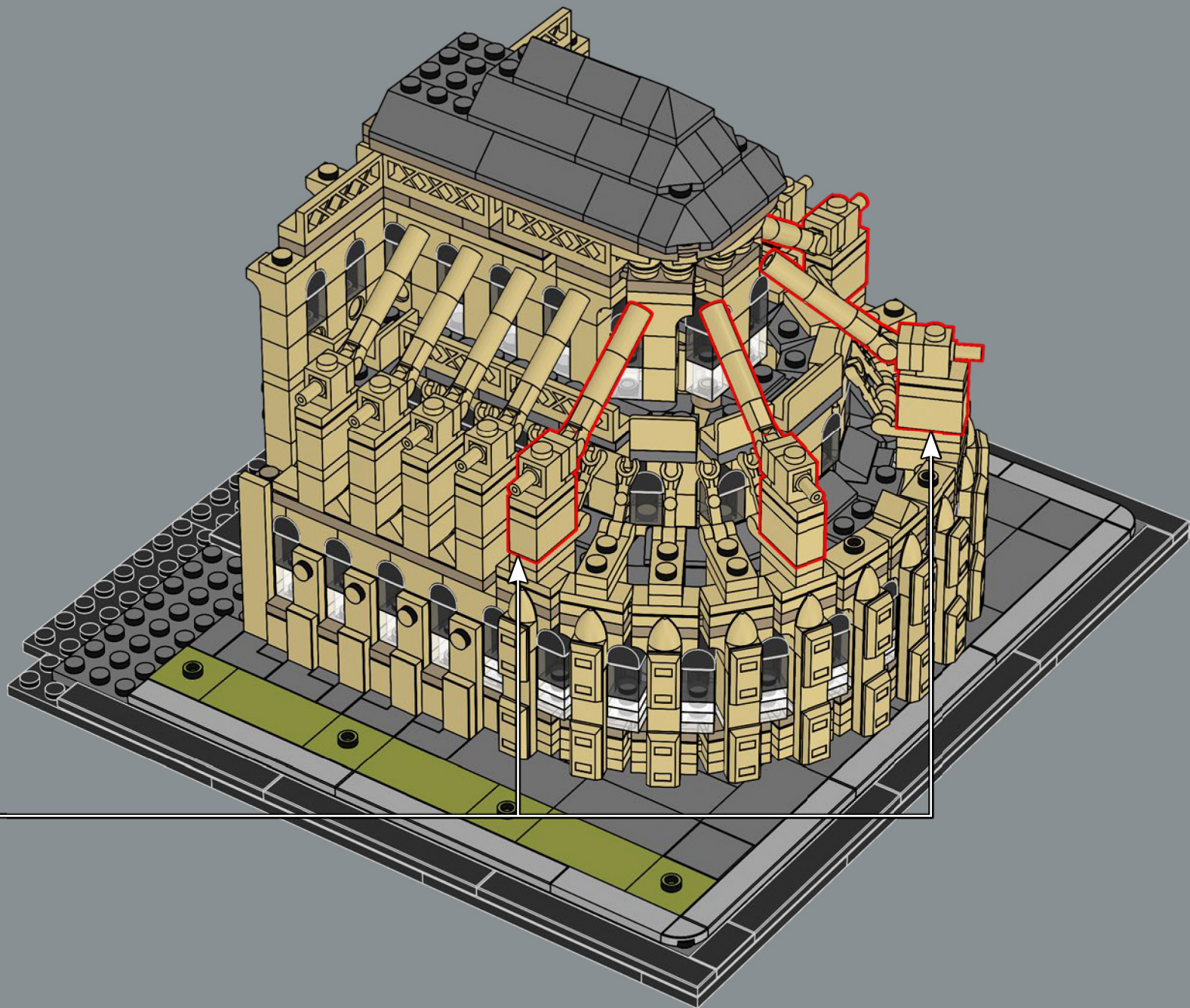

La Catedral de Notre Dame es la primera en integrar plenamente los arbotantes característicos de la arquitectura gótica.

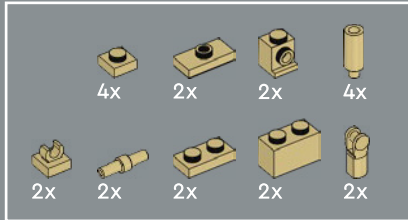
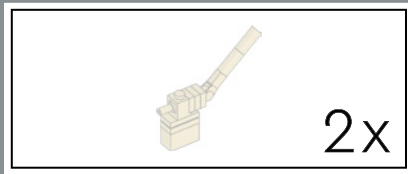

119

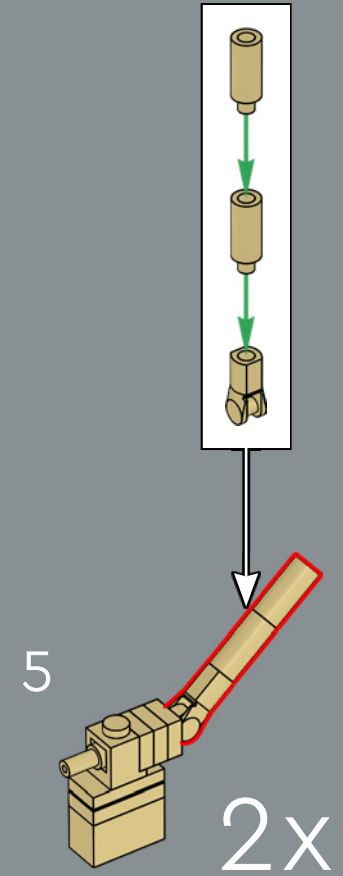
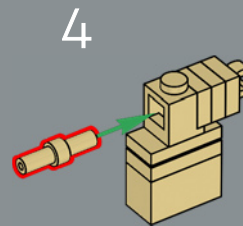
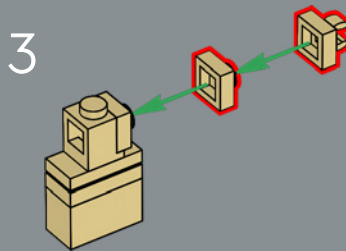
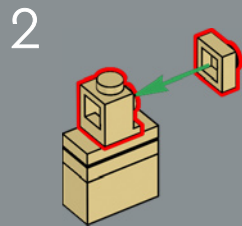
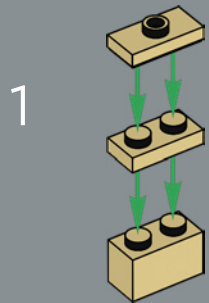

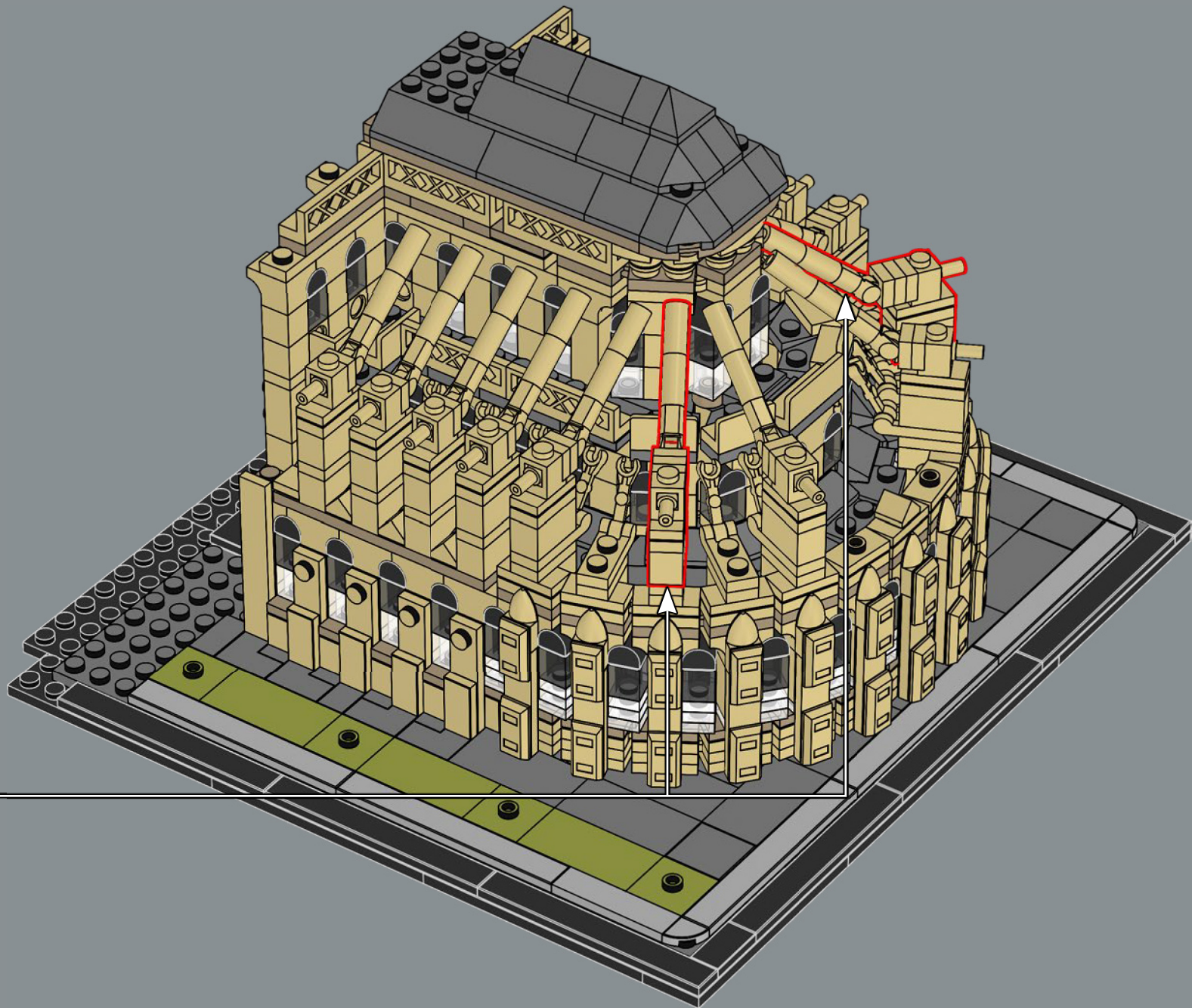

UN MONUMENTO LEGO® COBRA FORMA

1182-1200



La construcción prosigue en la nave transversal y en los tramos del lado meridional de la nave principal.

✂ Con 128 m de longitud, 48 m de anchura y 69 m de altura, la Catedral de Notre Dame se edificó en la isla de la Cité, en el Sena, sobre el terreno de una catedral anterior. Mientras la primera sección completada en el lado oriental servía como iglesia provisional, los trabajos de construcción continuaban su curso en la nave transversal y en los primeros tramos del lado meridional de la nave principal. Partiendo del estilo románico original, la construcción incorporó gradualmente estilos arquitectónicos contemporáneos hasta llegar al estilo gótico que muestra en la actualidad. Este modelo se mantiene fiel a la construcción tanto de la estructura interior como de los detalles arquitectónicos exteriores (cuya escala se ha reducido en algunos casos) a fin de recrear la impresionante vista que ha asombrado a los visitantes a lo largo de los siglos.

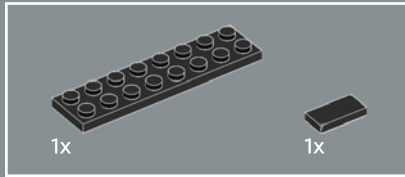
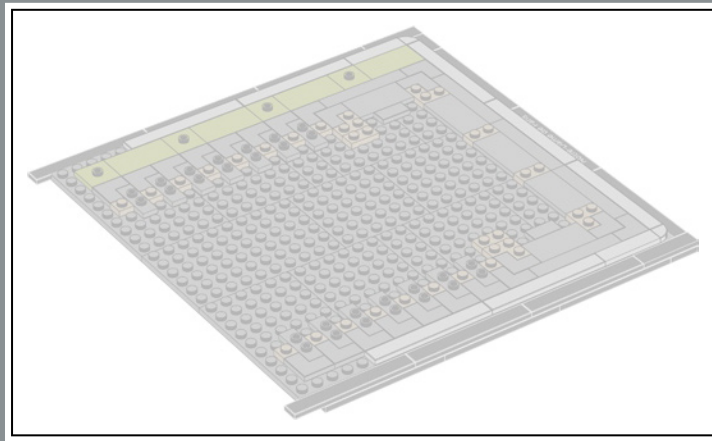

120

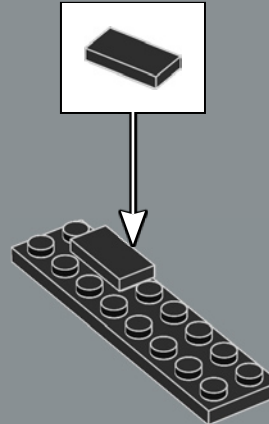

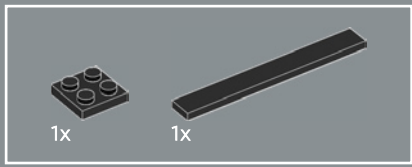

121

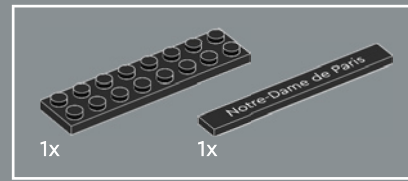
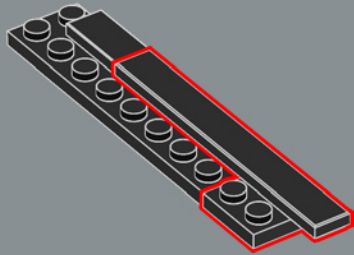

122

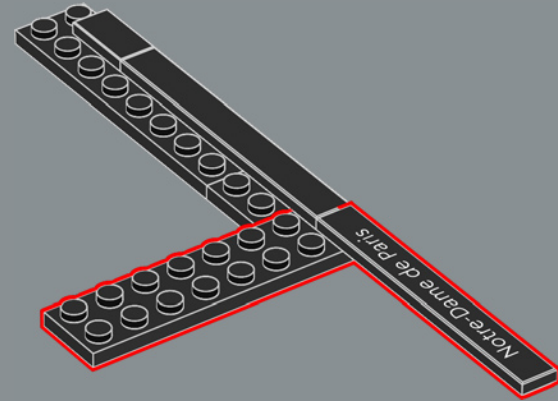

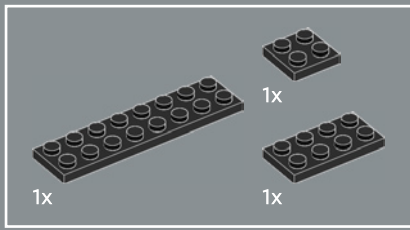

123

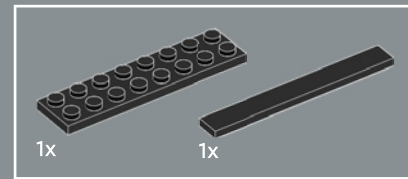
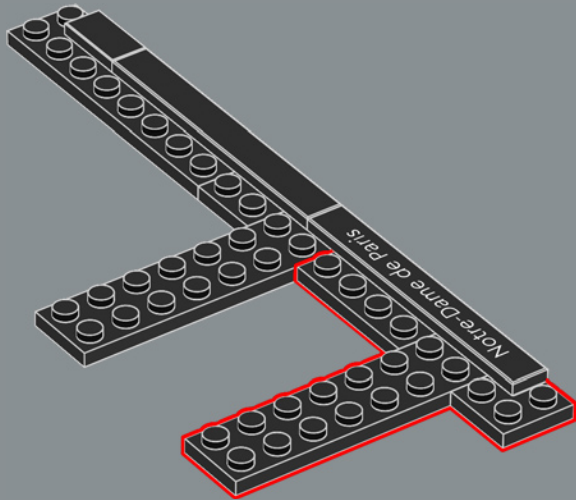

124

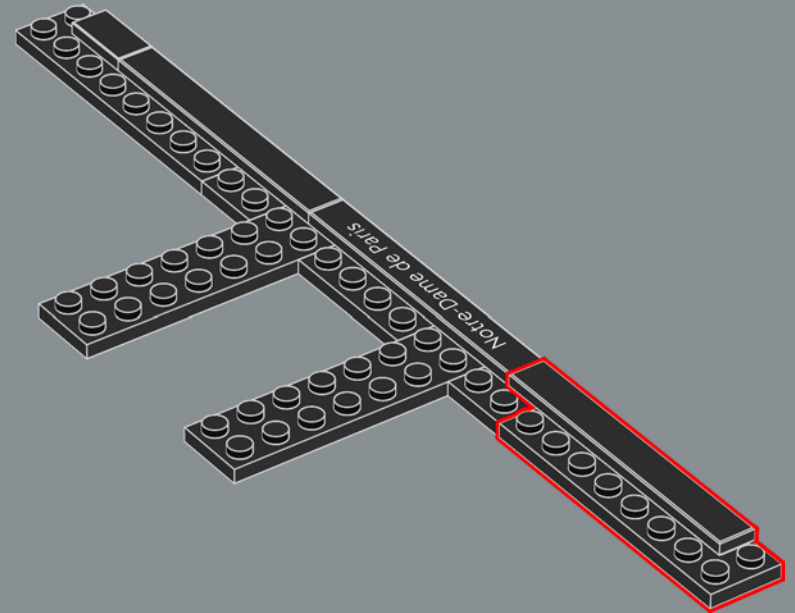

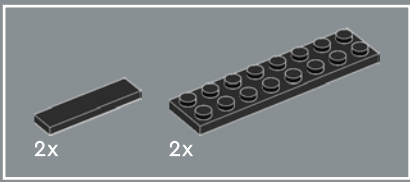

125

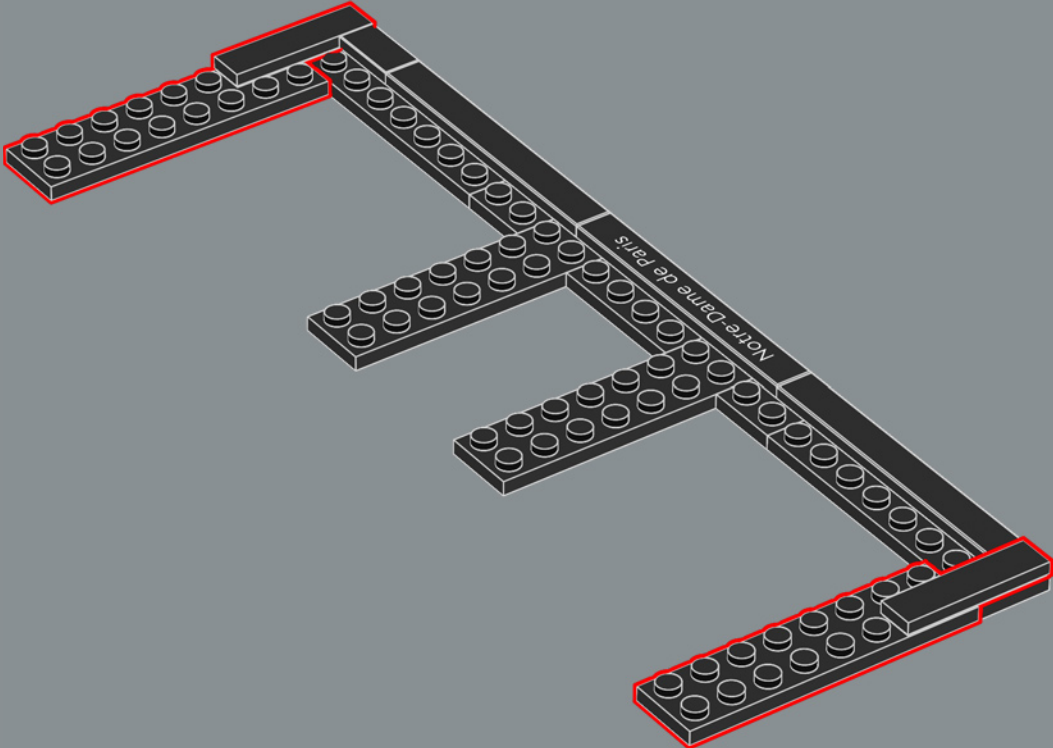

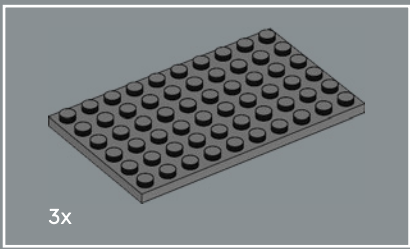

126

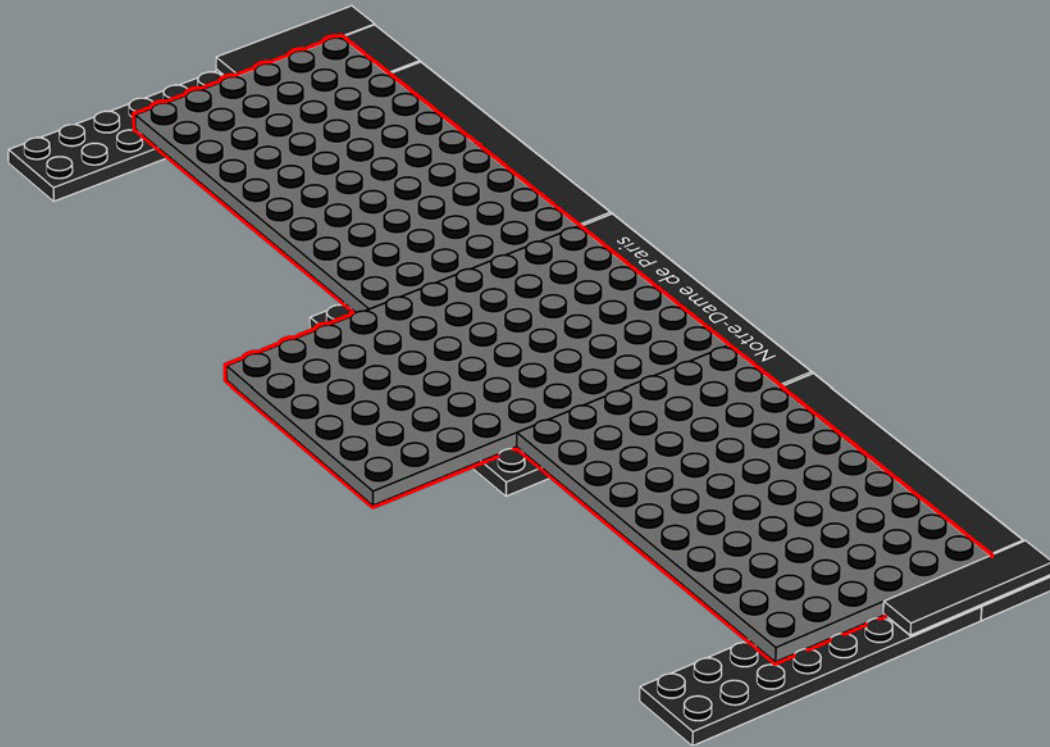

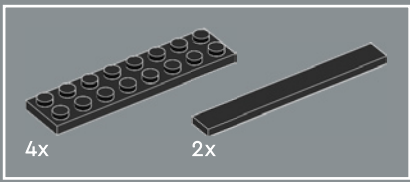

127

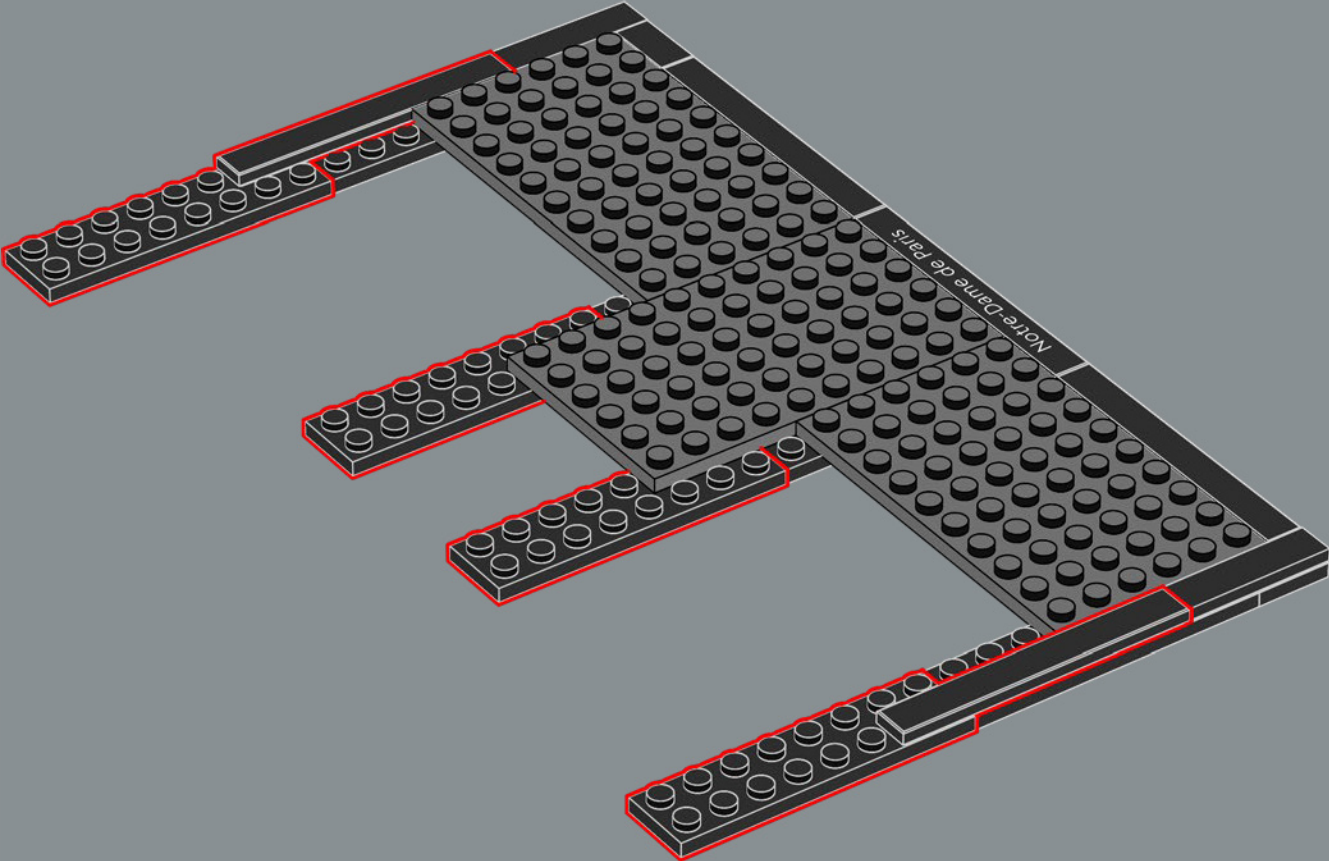

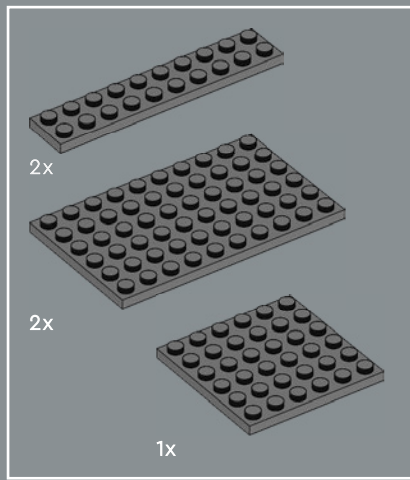

128

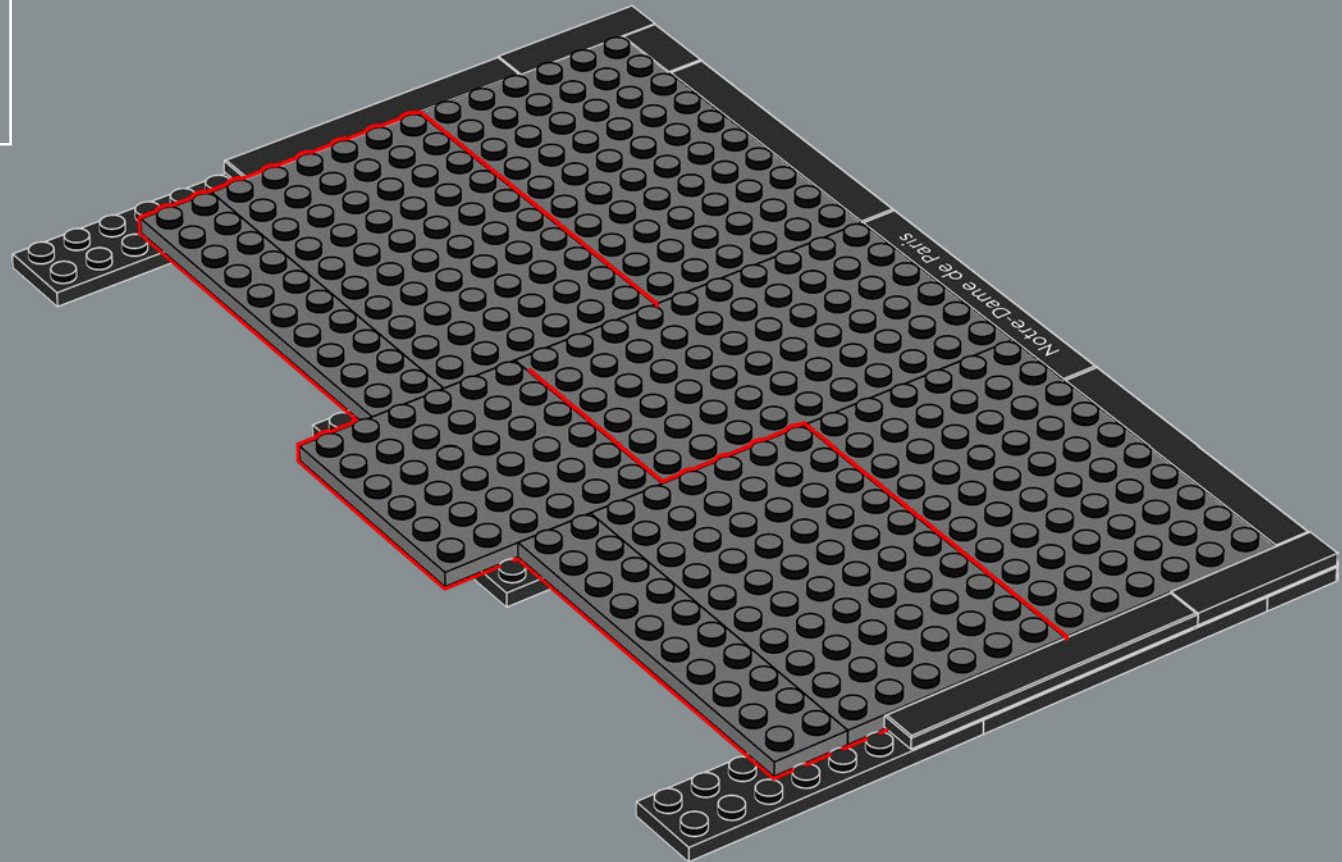

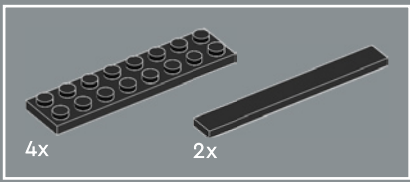

129

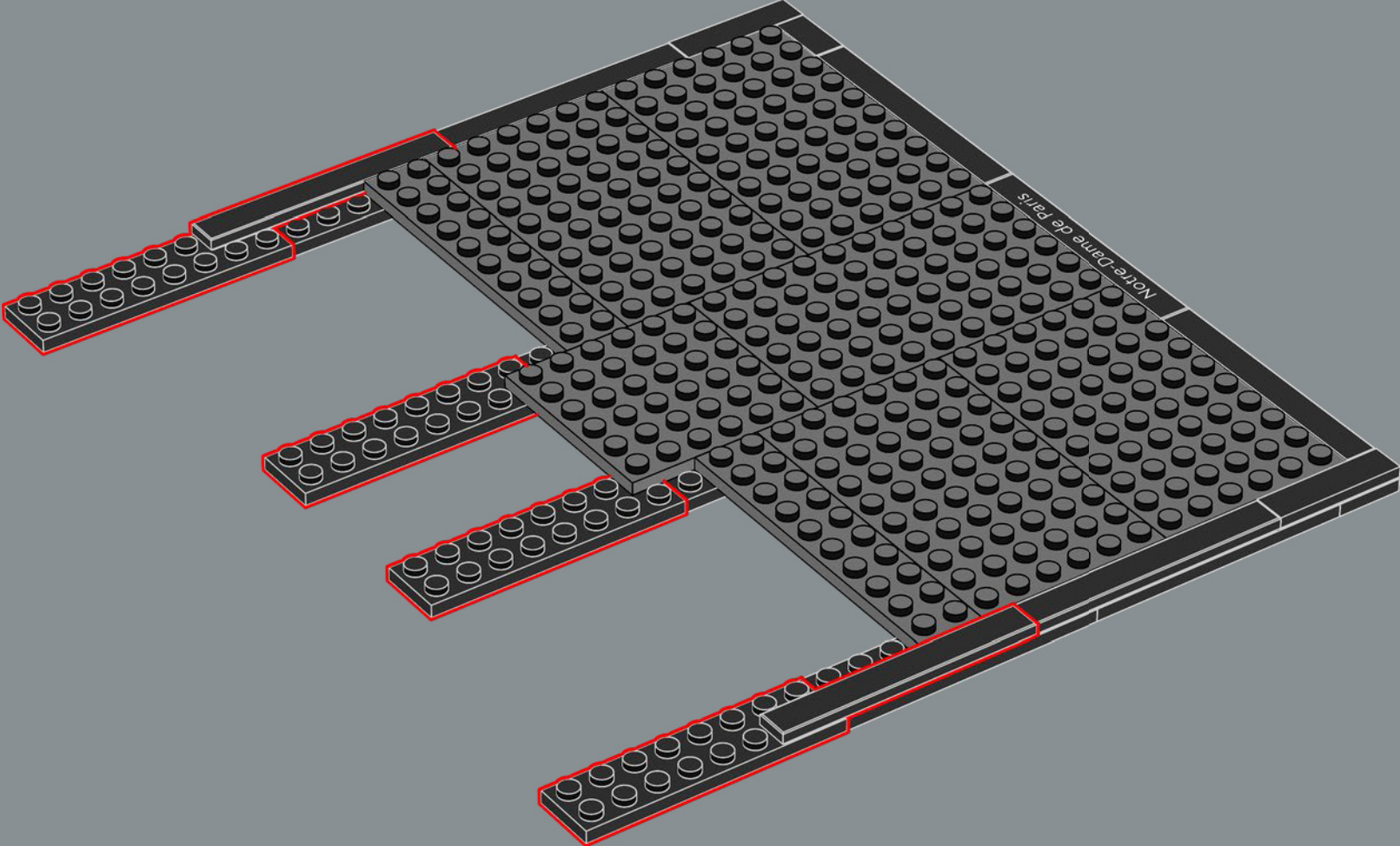

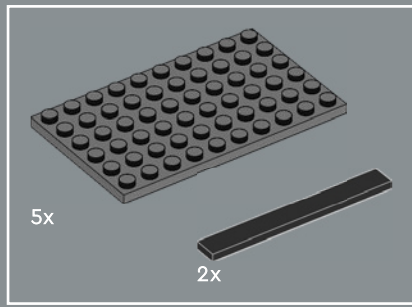

130

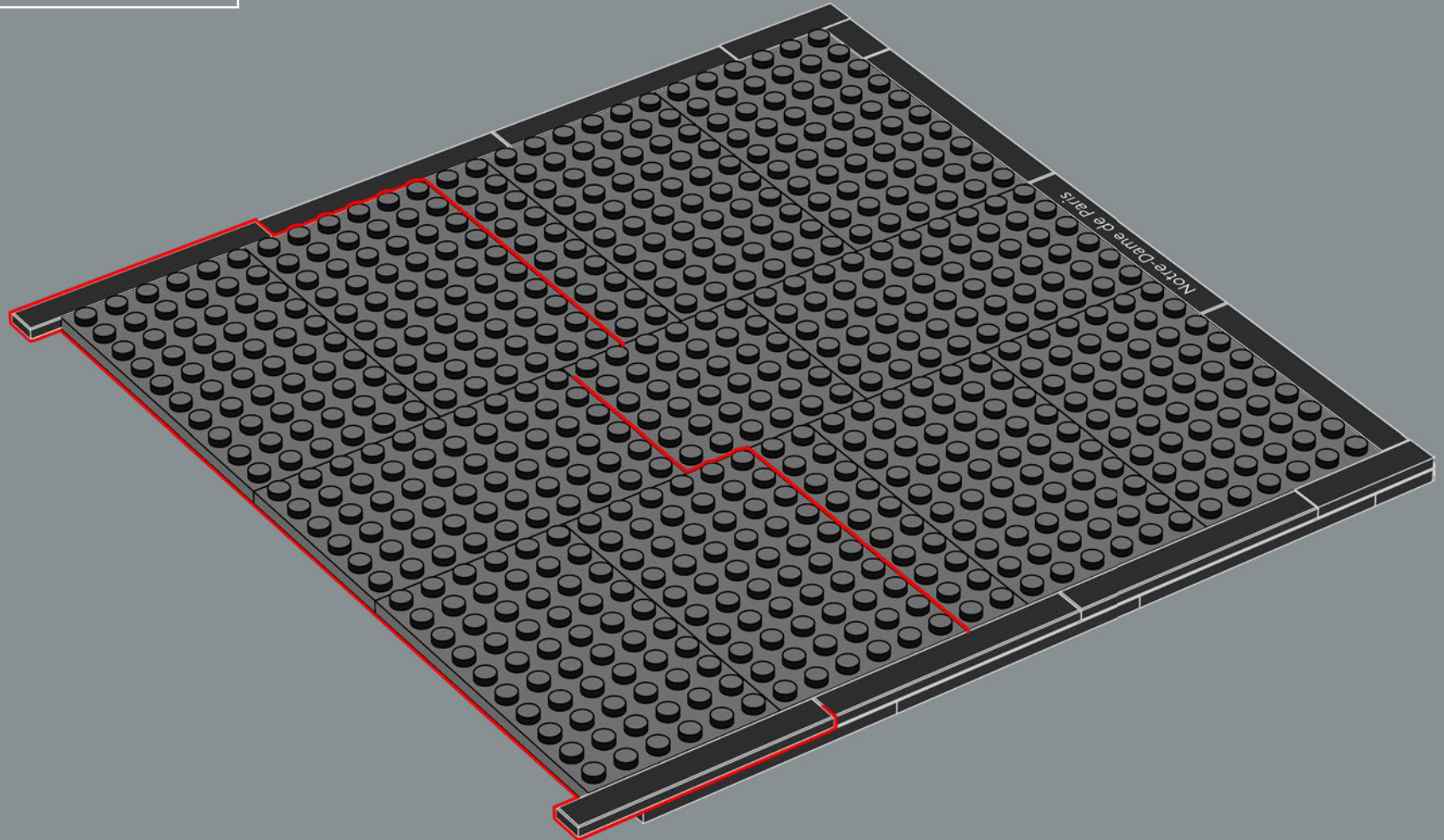

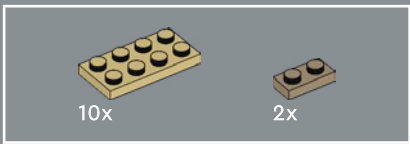

131

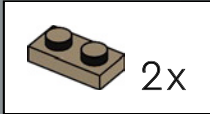
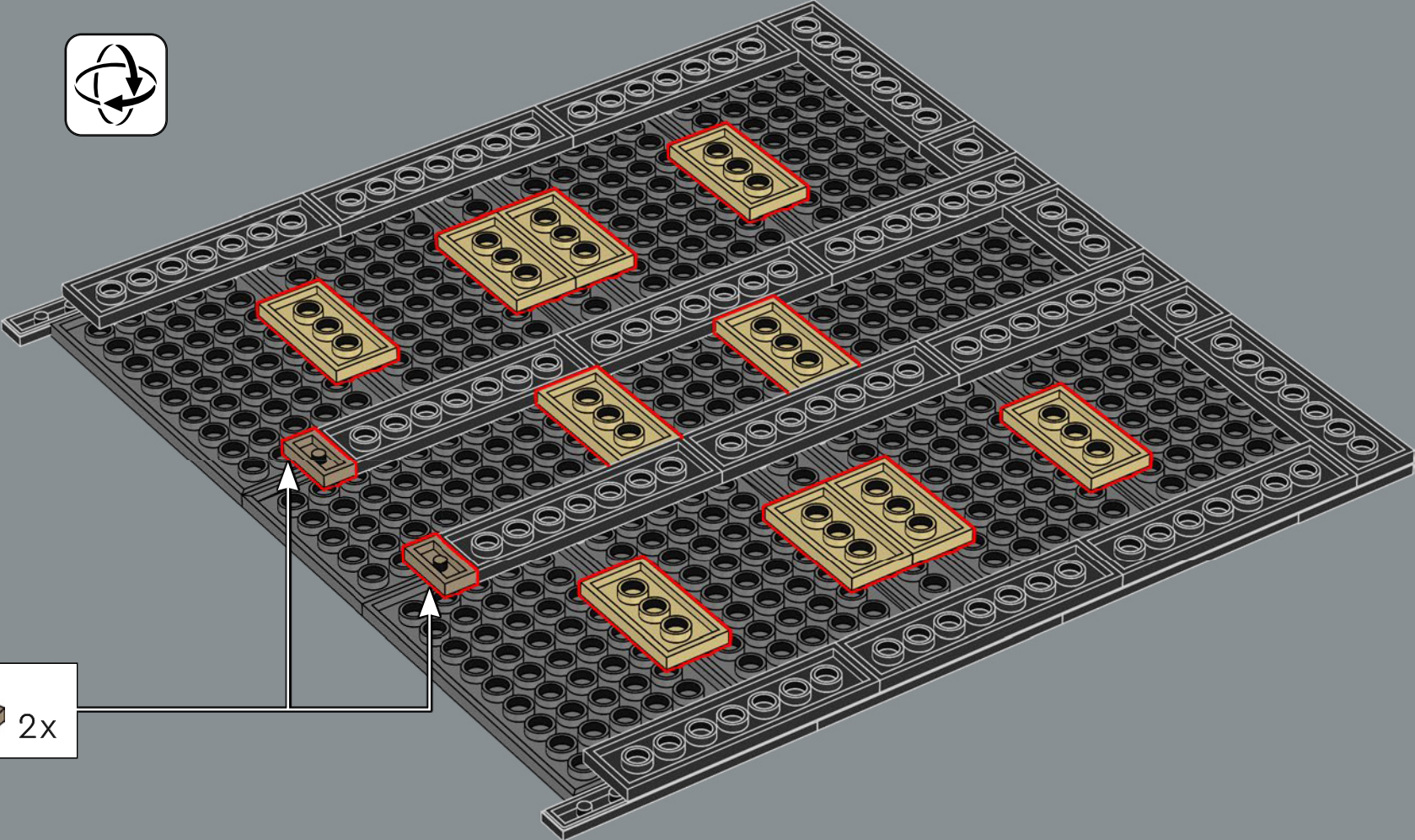

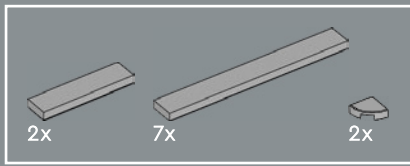

132

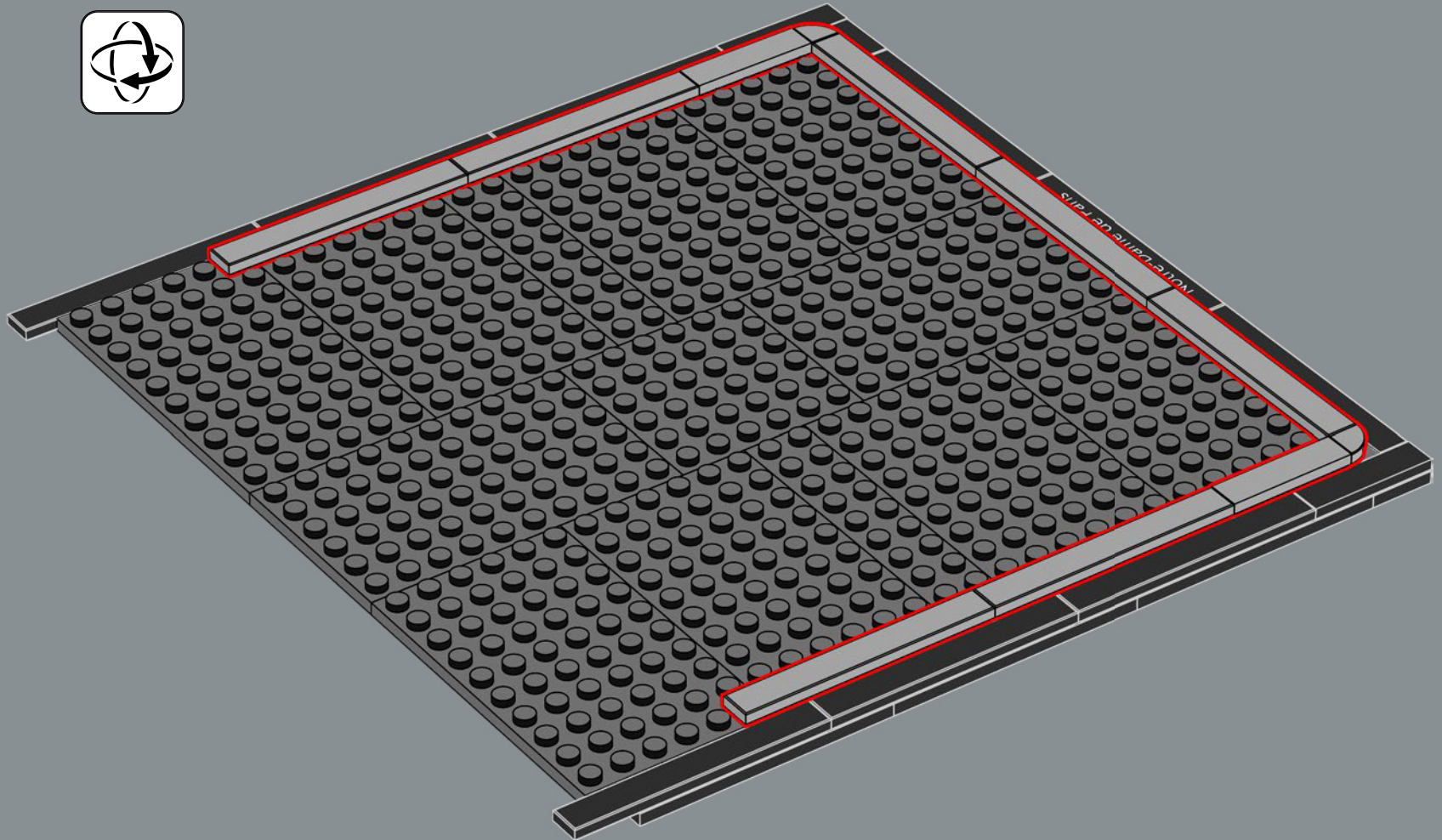

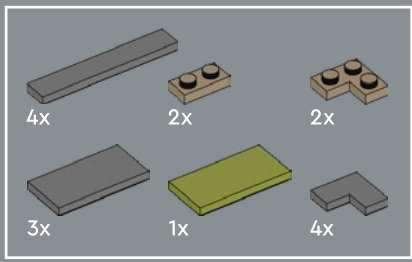

133

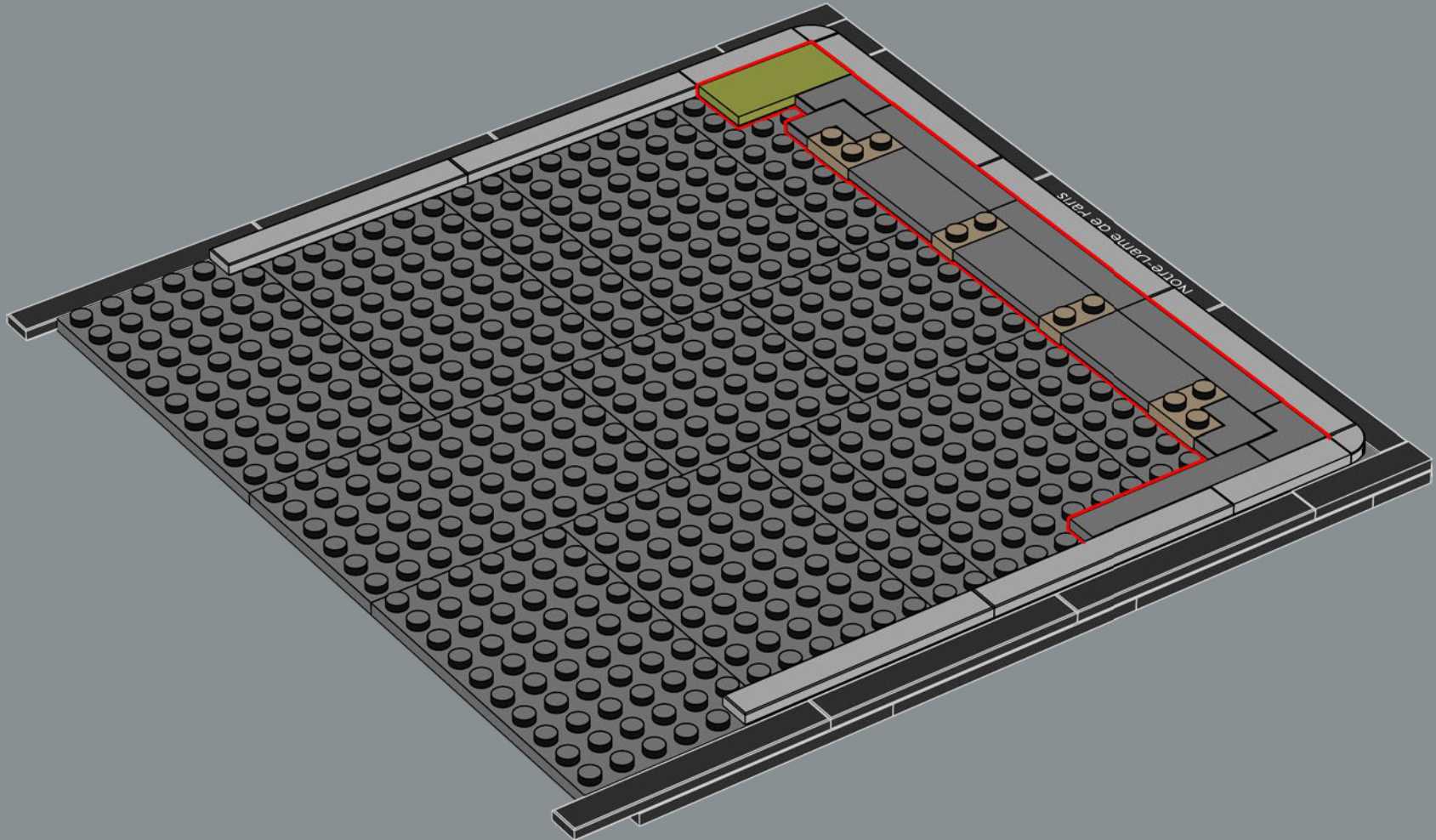

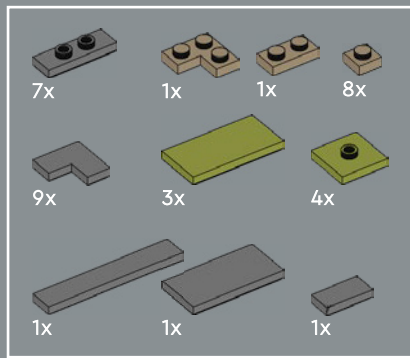

134

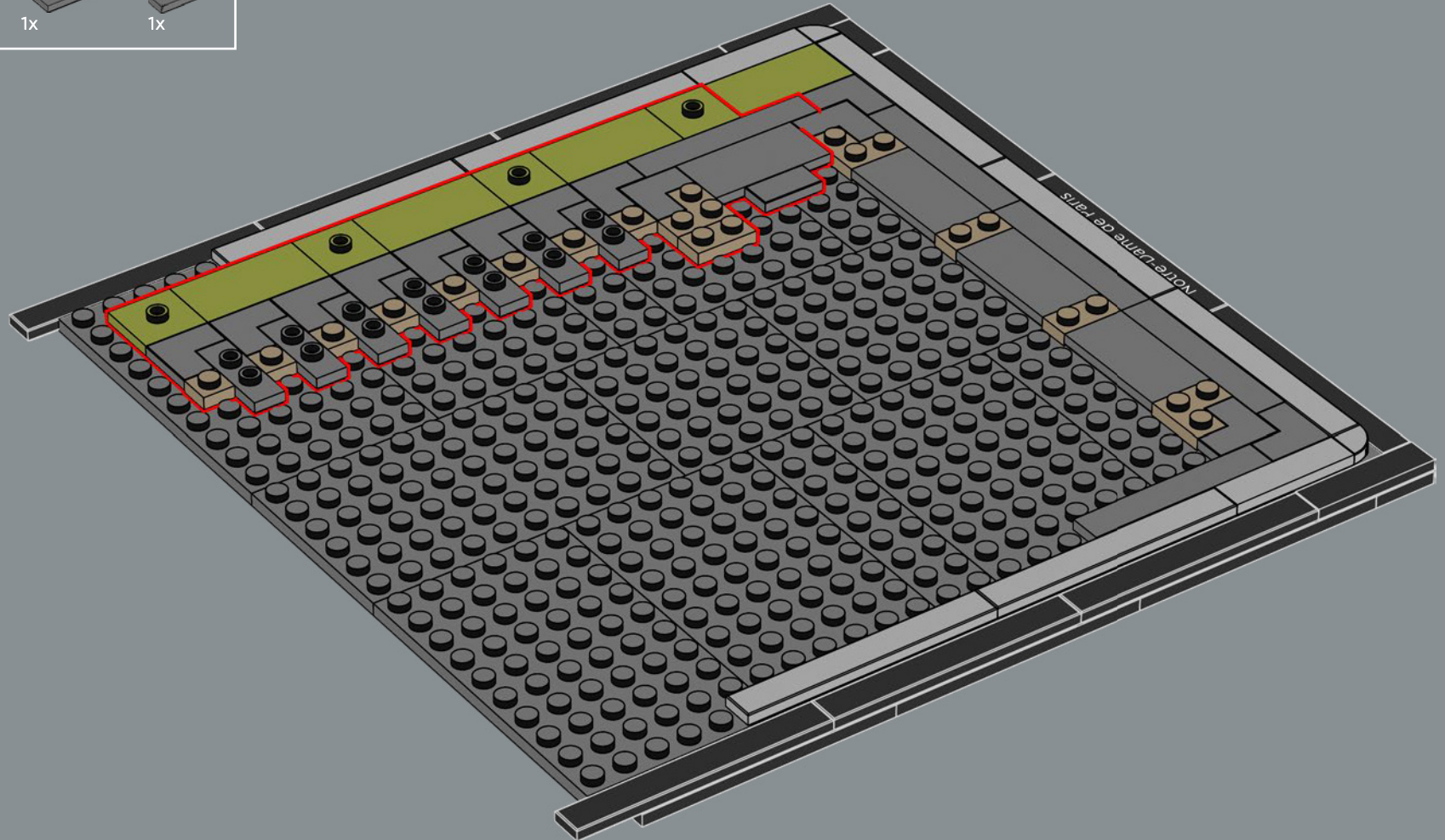

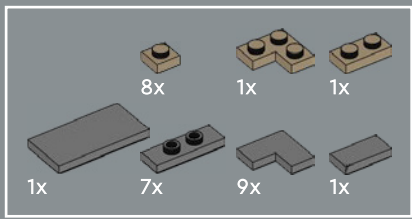

135

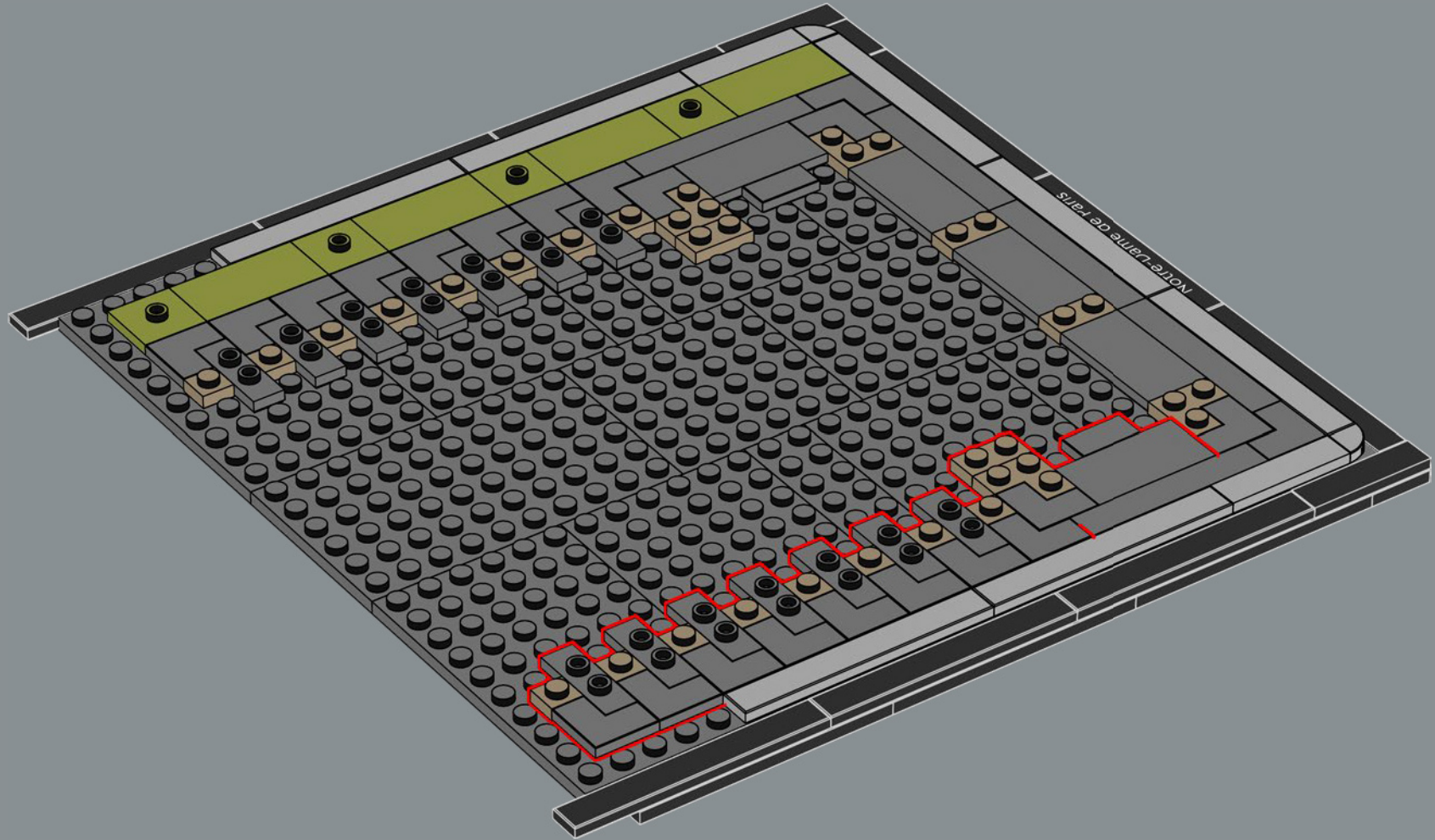

136

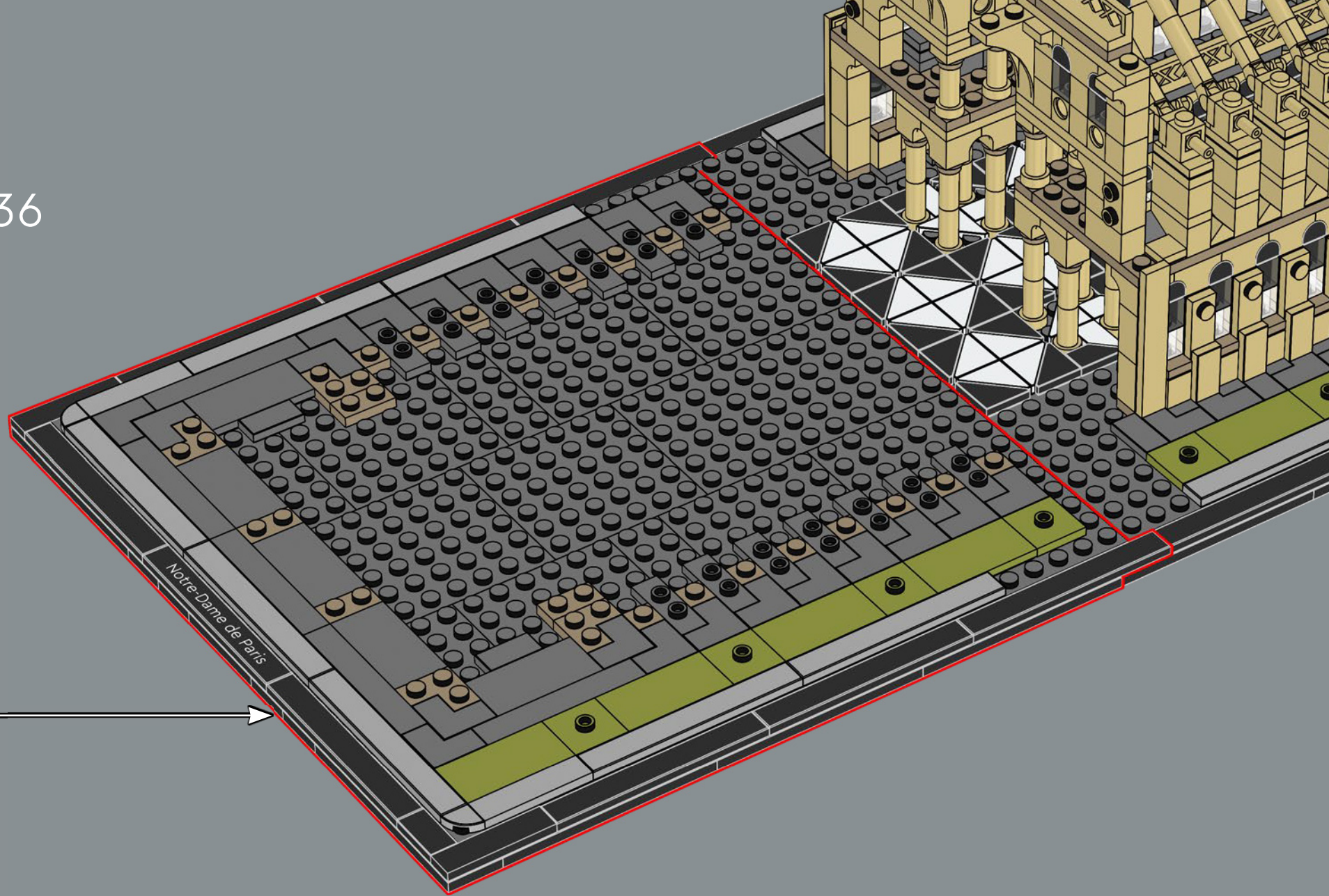

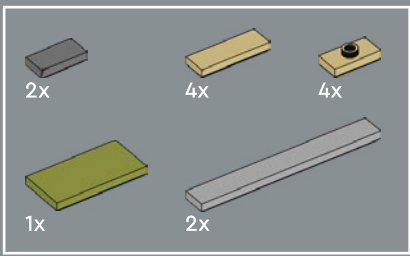

137

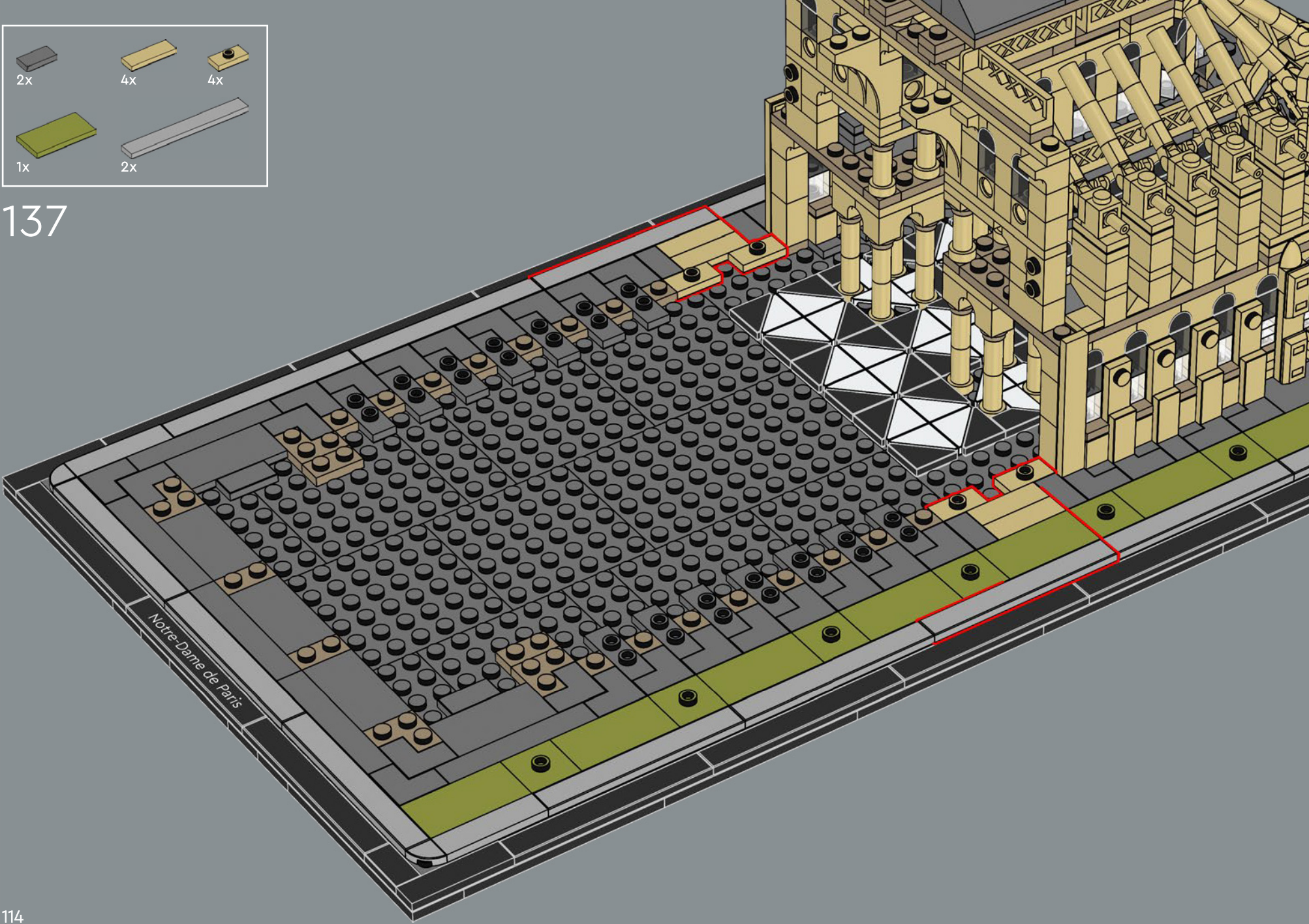

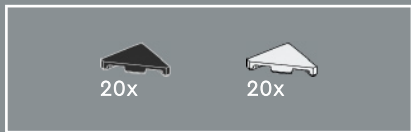

138

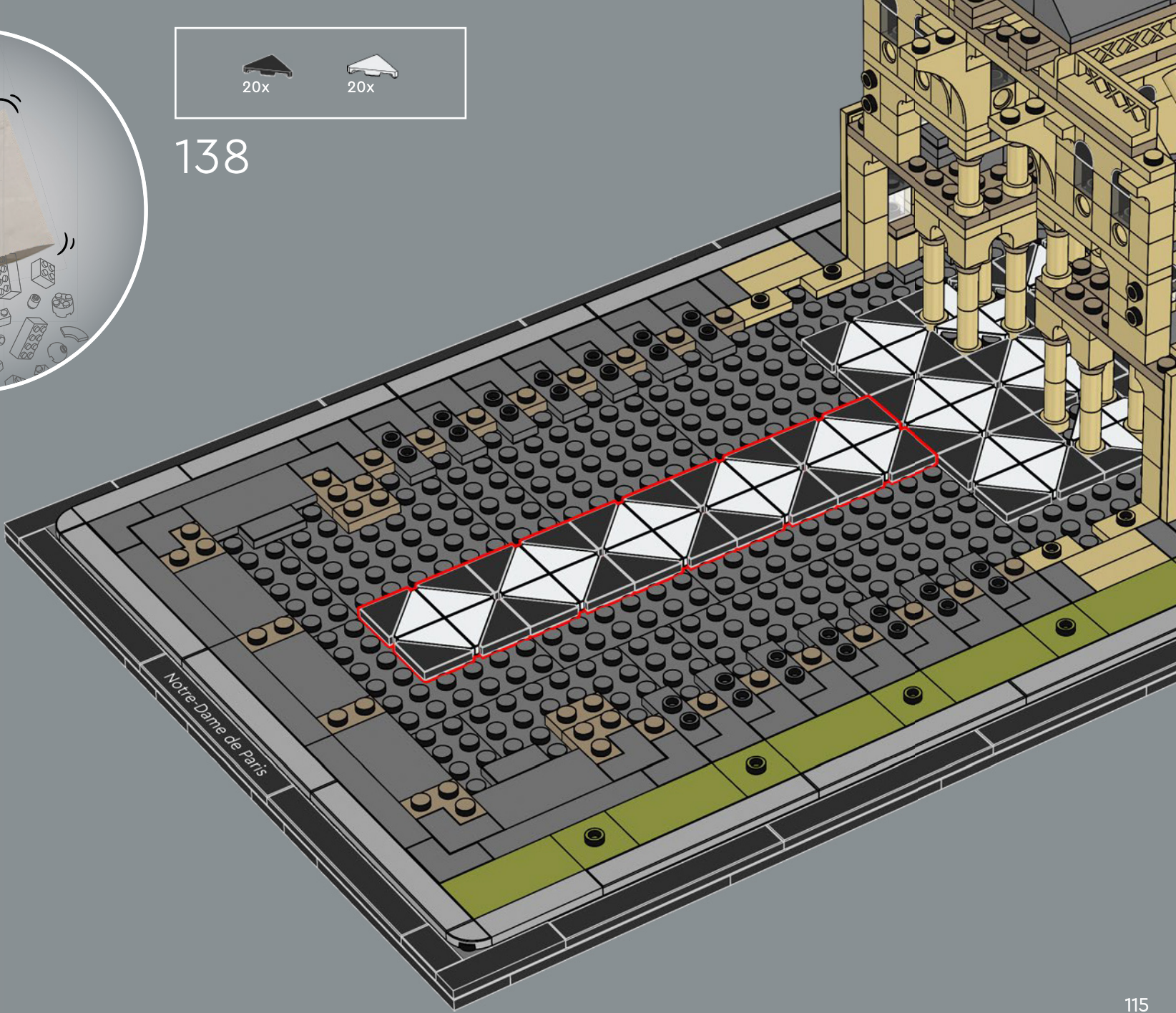

2x 30x

139

30x

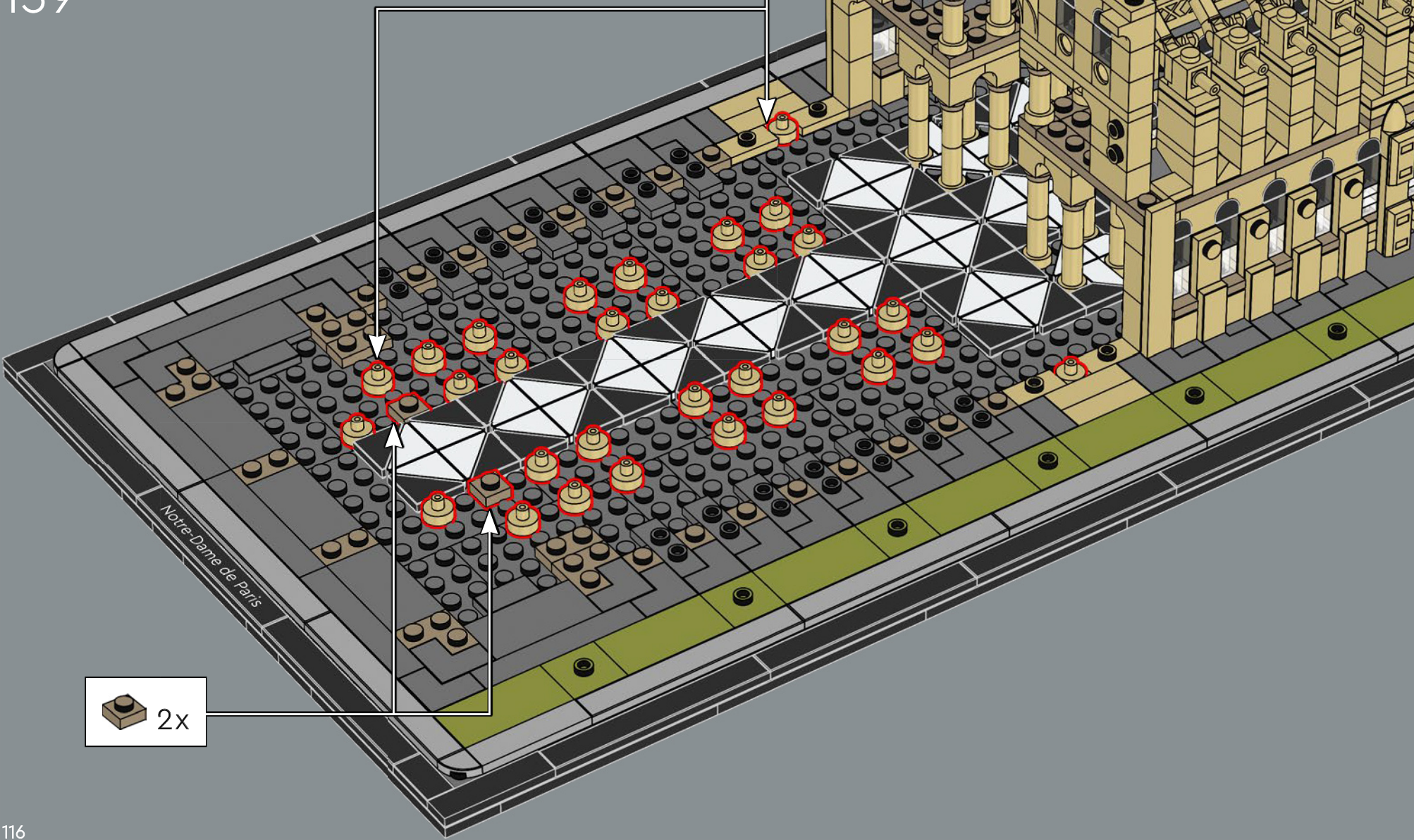

2x

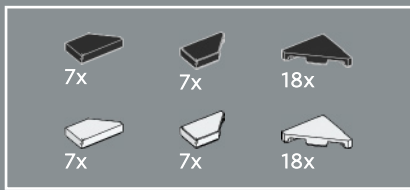

140

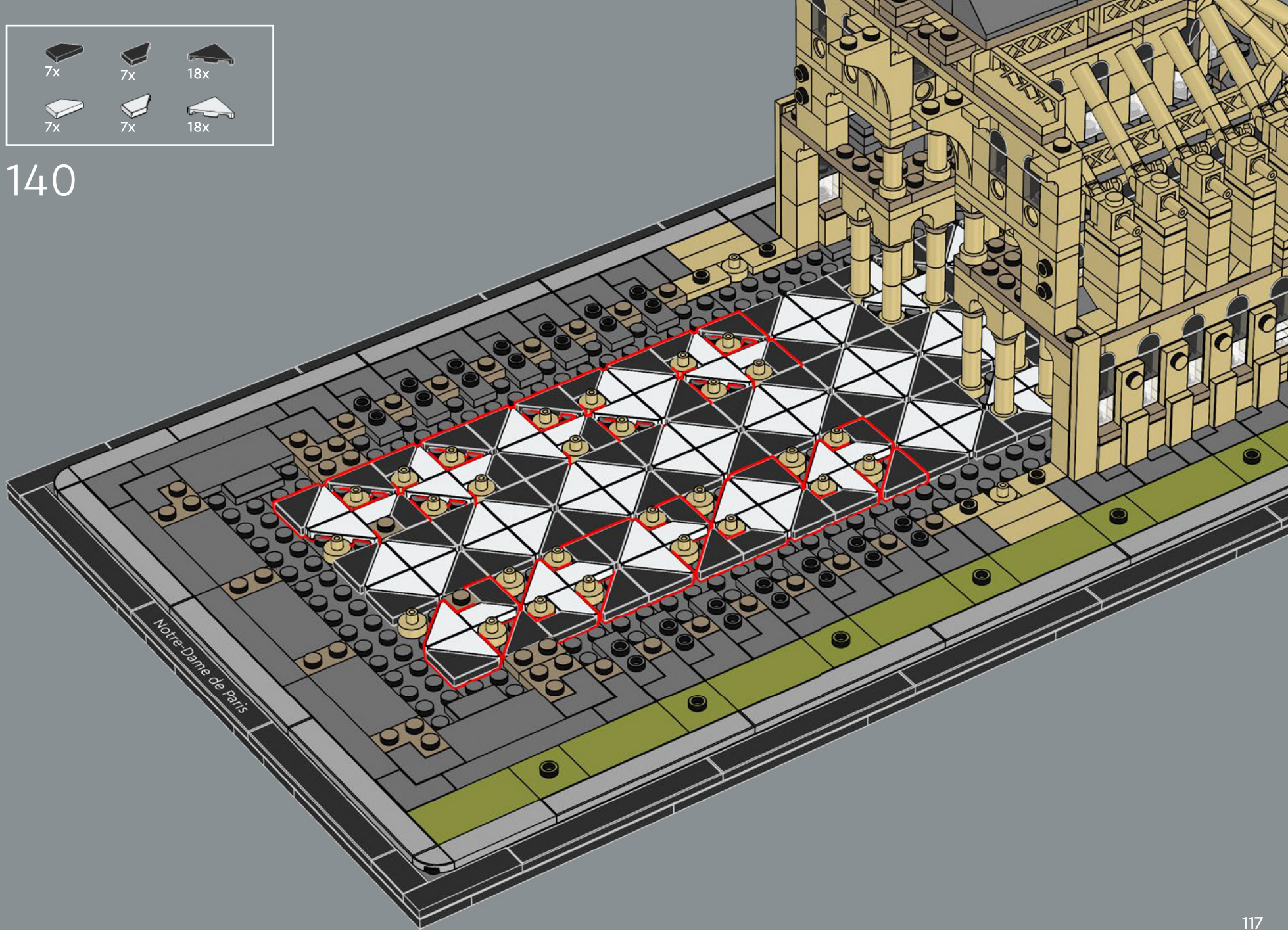



141

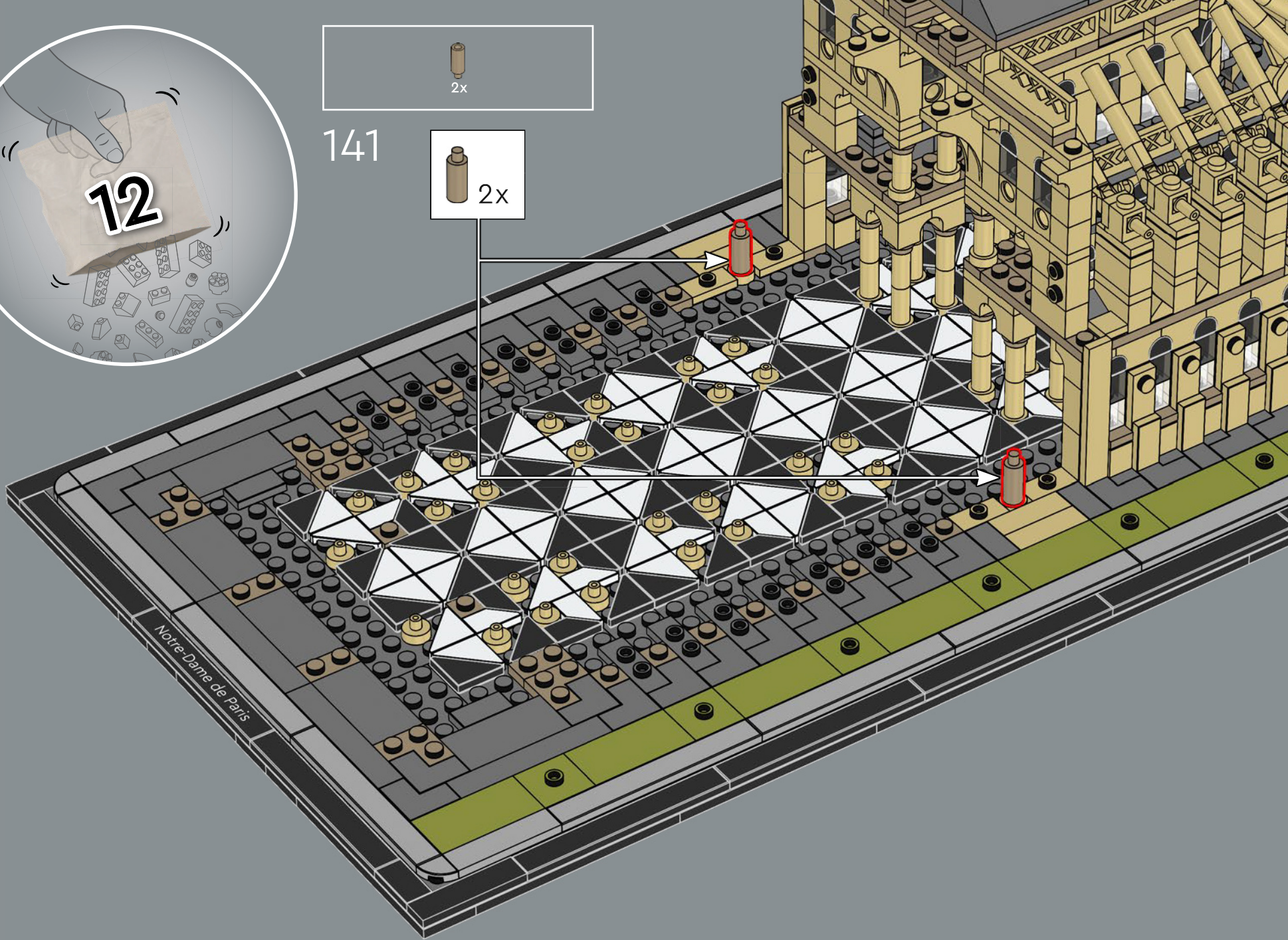
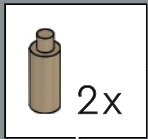

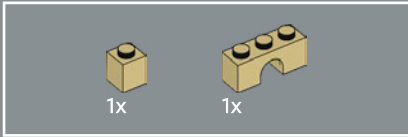
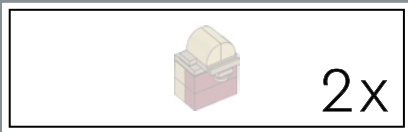

142

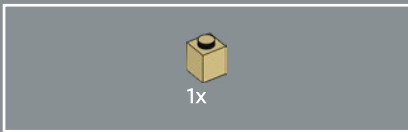
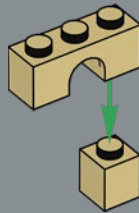

143

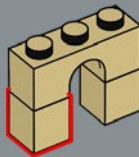

144

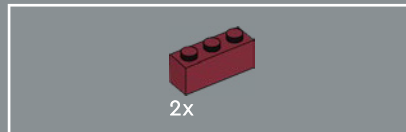
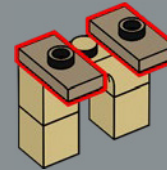

145

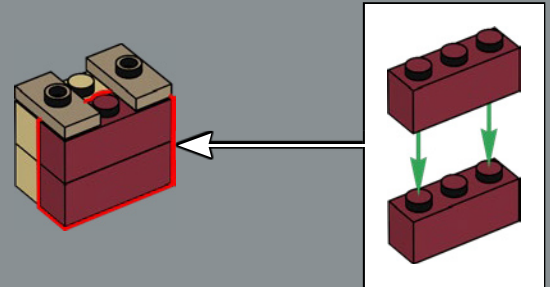

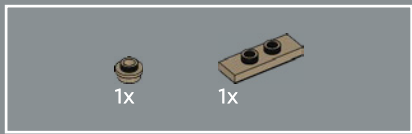

146

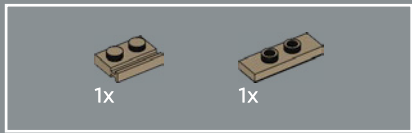
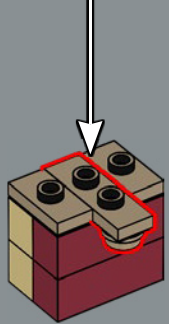
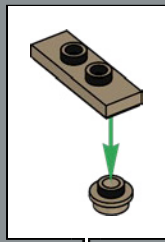

147

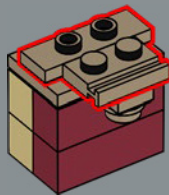

148

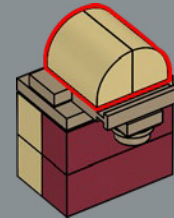

2x

149

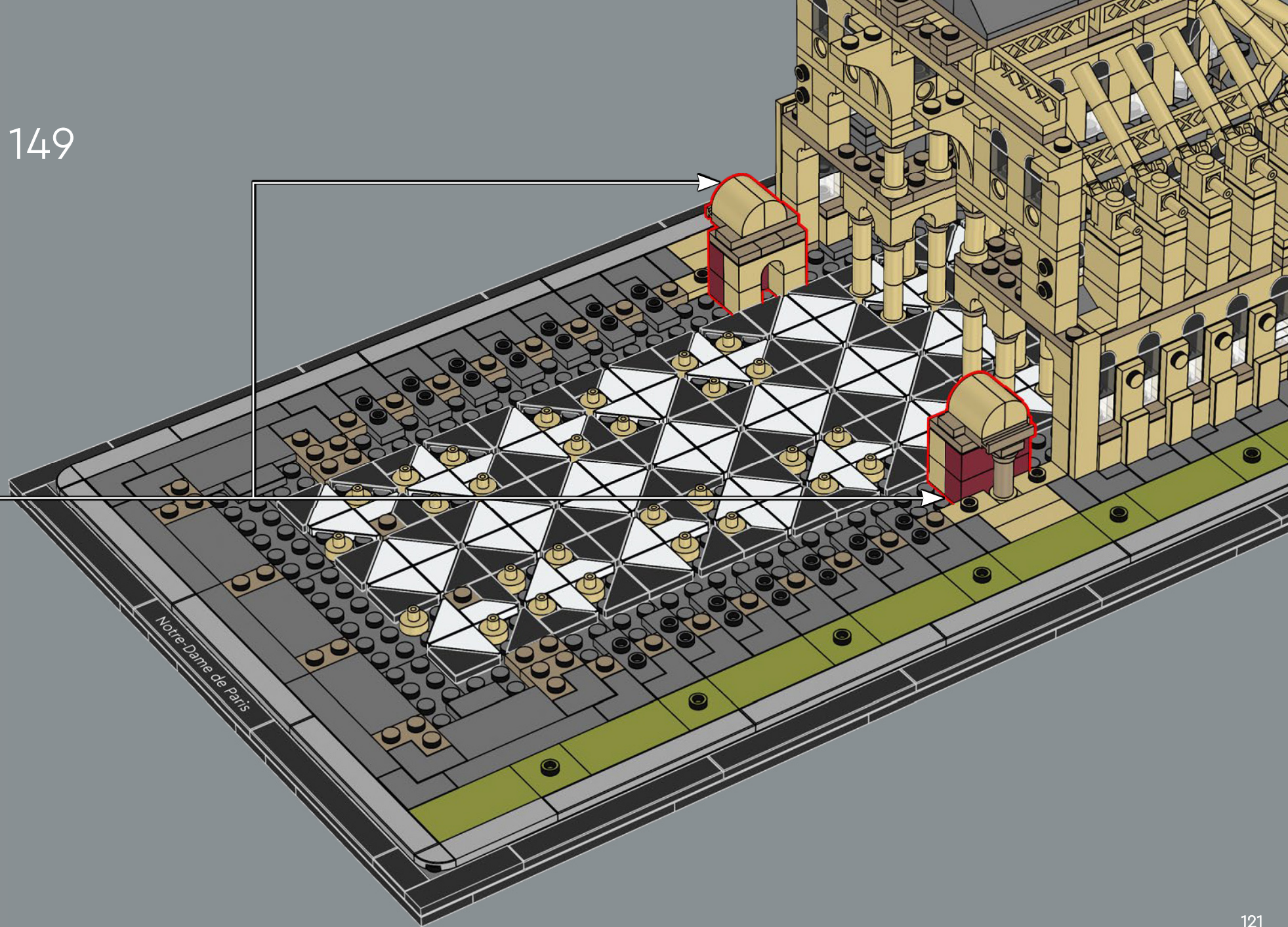

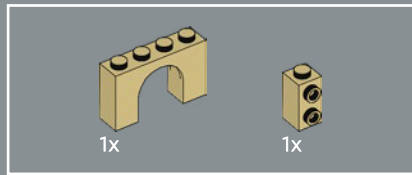
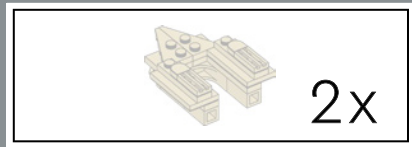

150

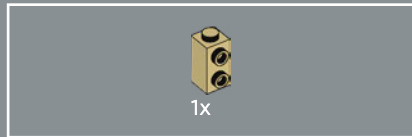
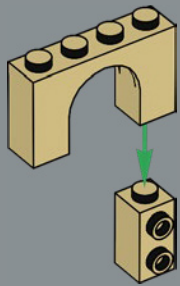

151

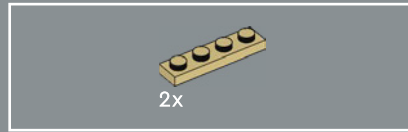
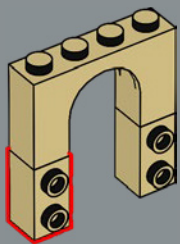

152

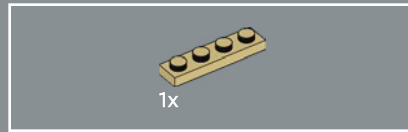
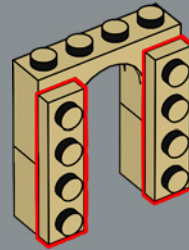

153

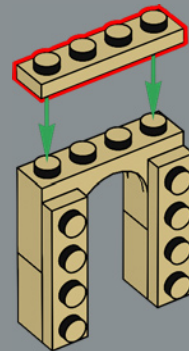

154

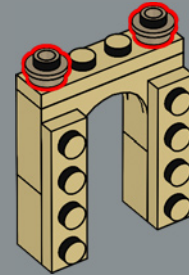

155

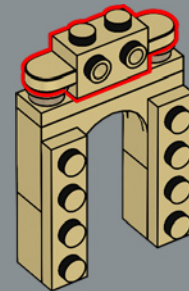

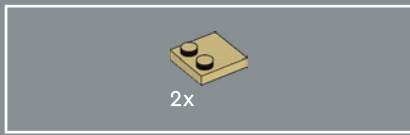

156

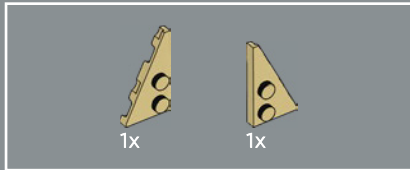
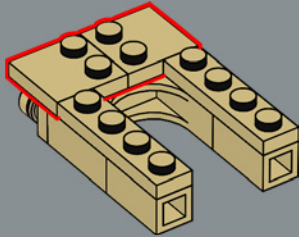

157

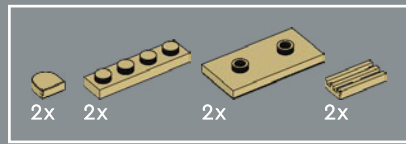
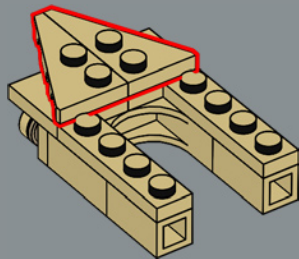

158

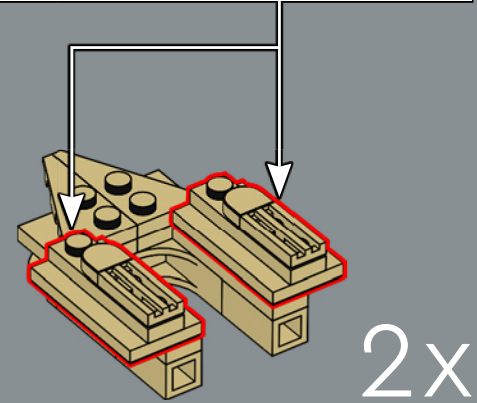
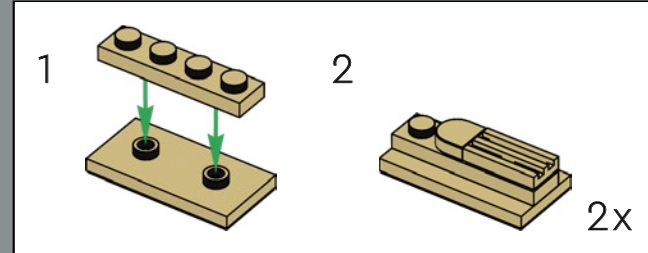

1182: Se aísla el coro de la parte en obras del edificio mediante un muro provisional. La construcción continúa de este a oeste en las naves transversal y principal.

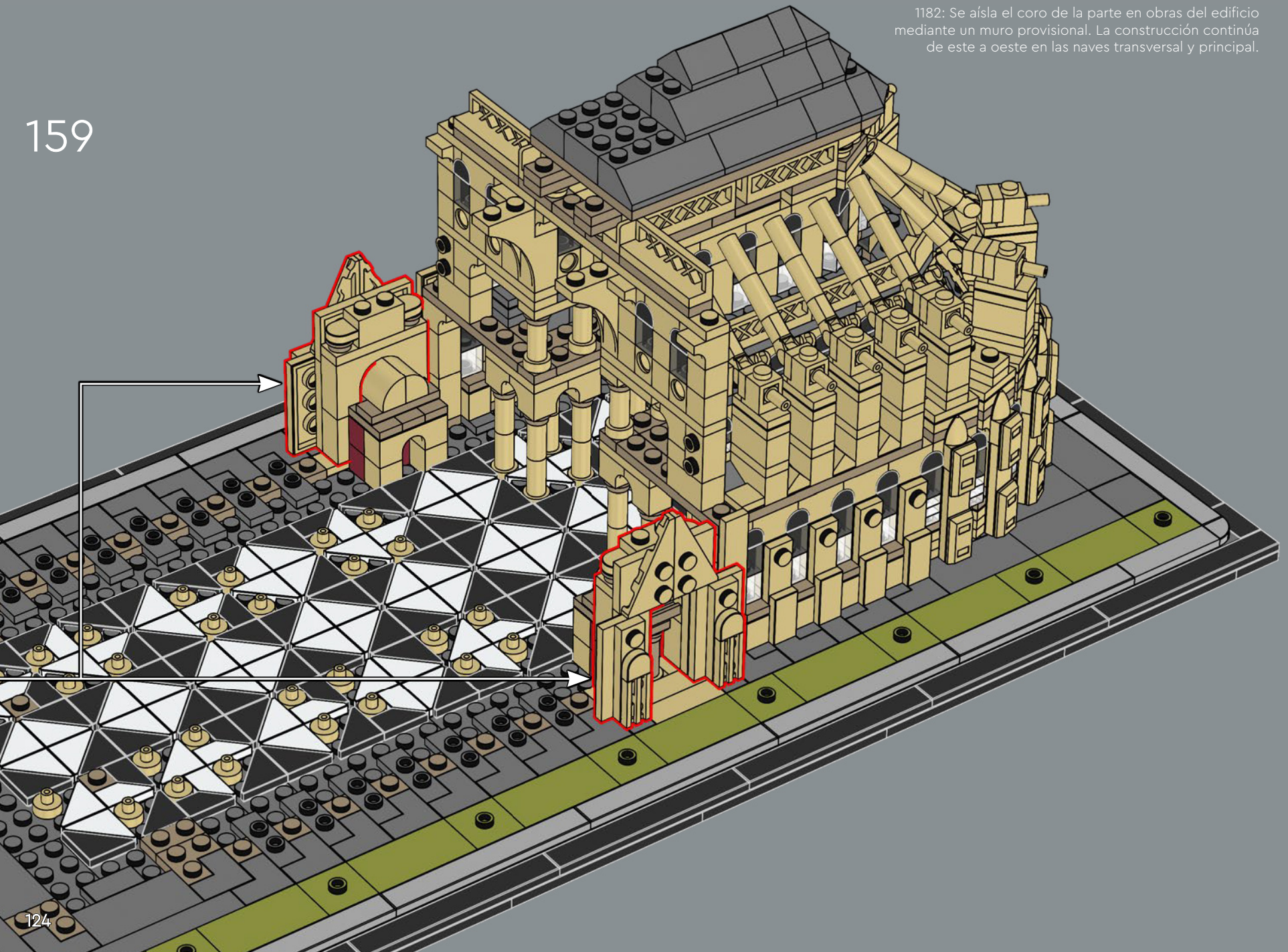

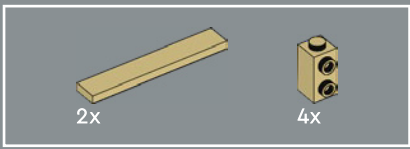

160

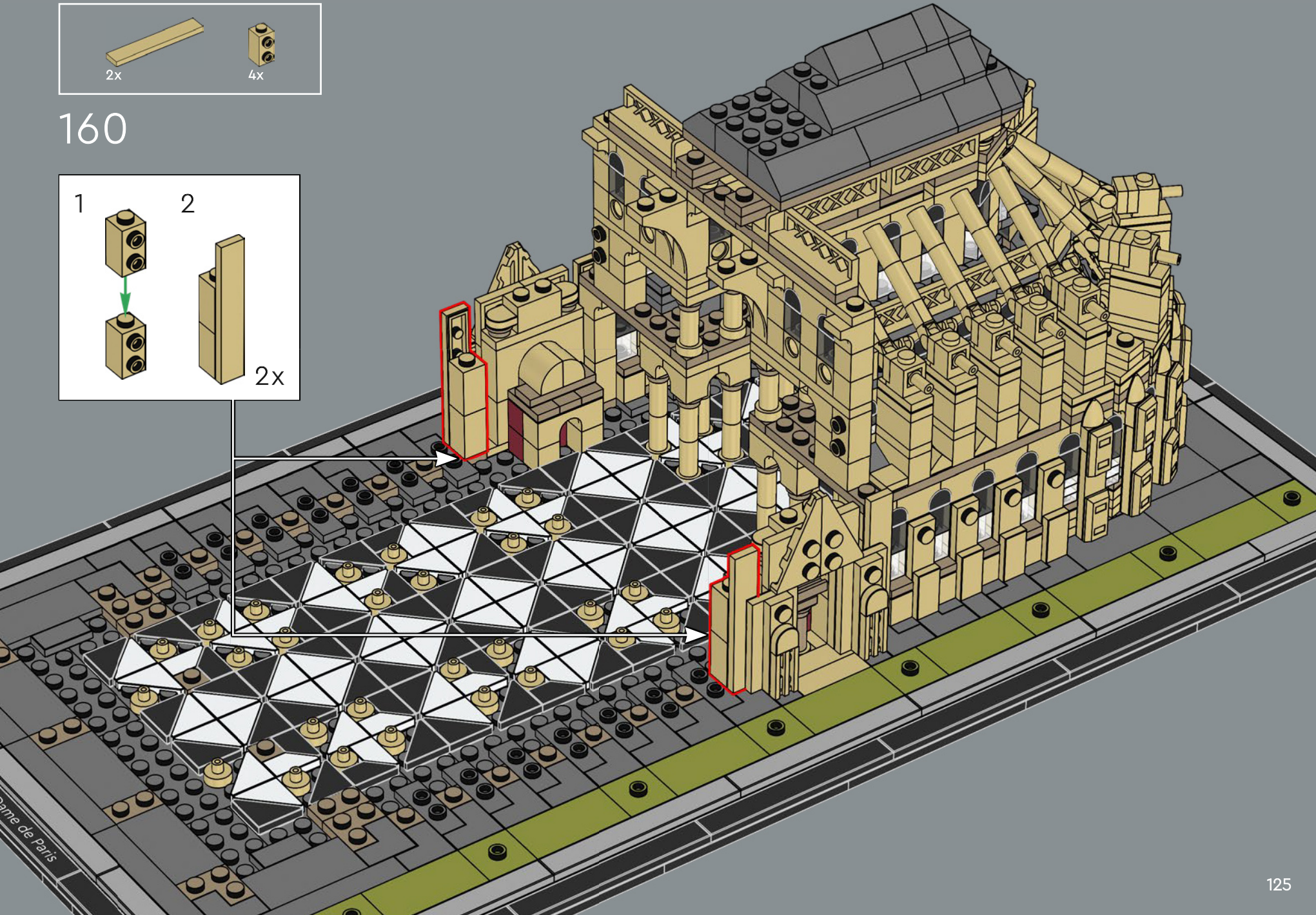
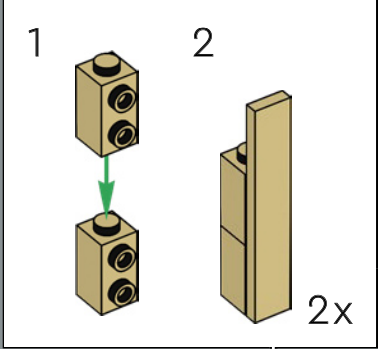

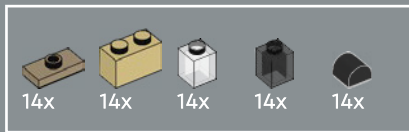

161

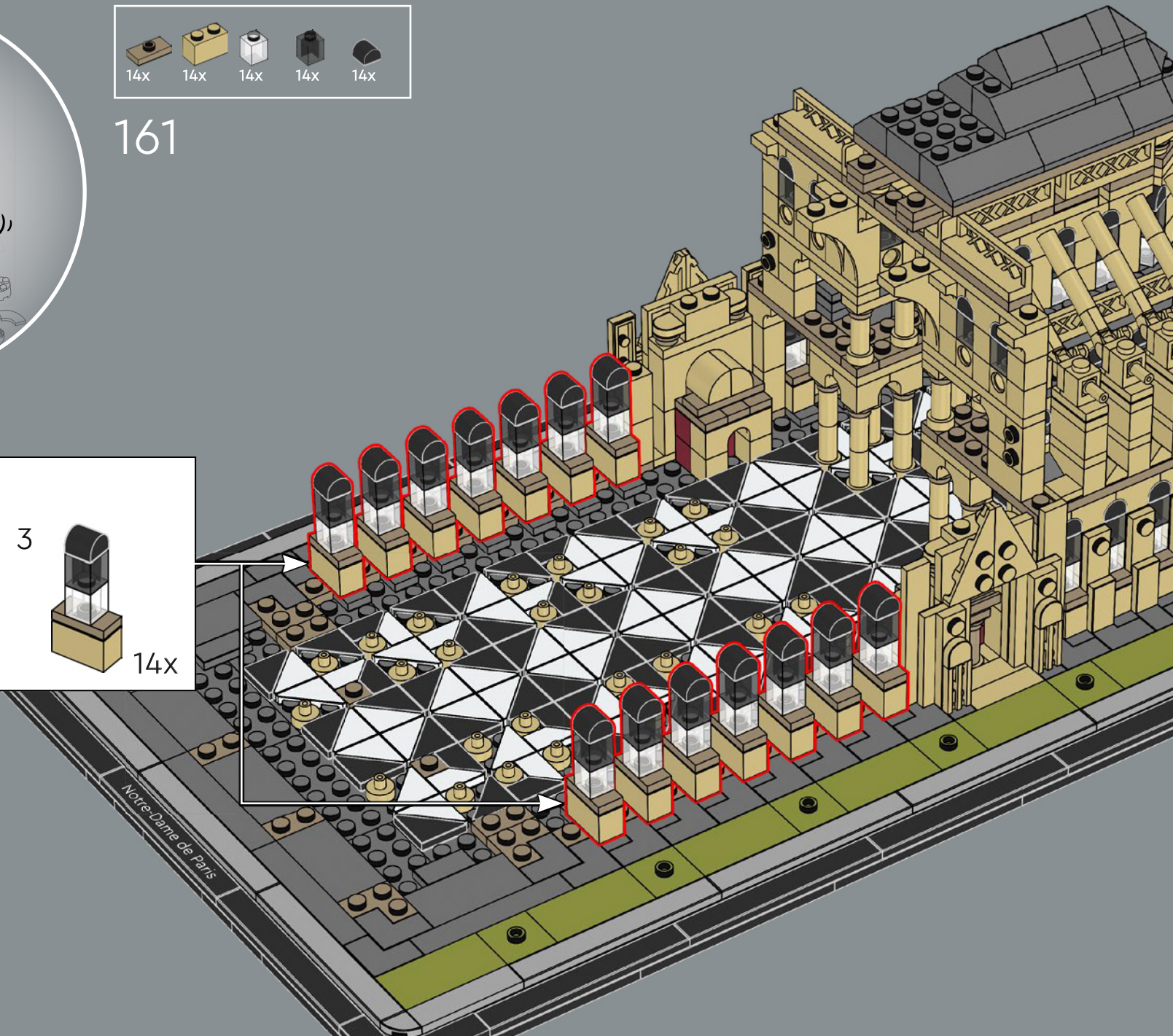
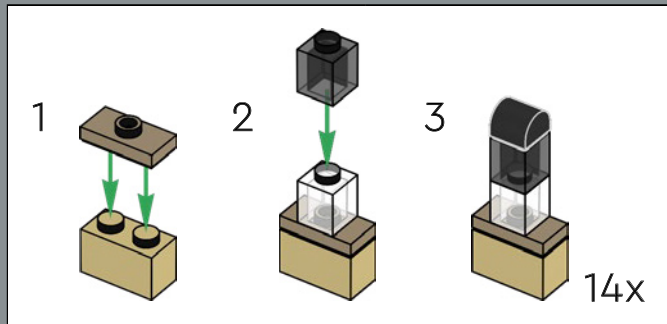

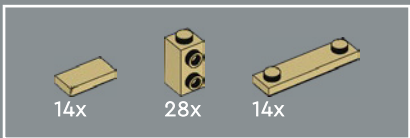

162

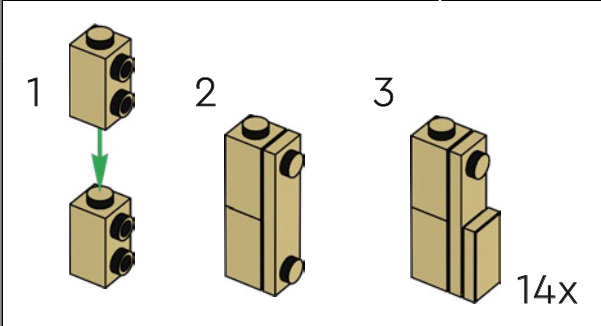
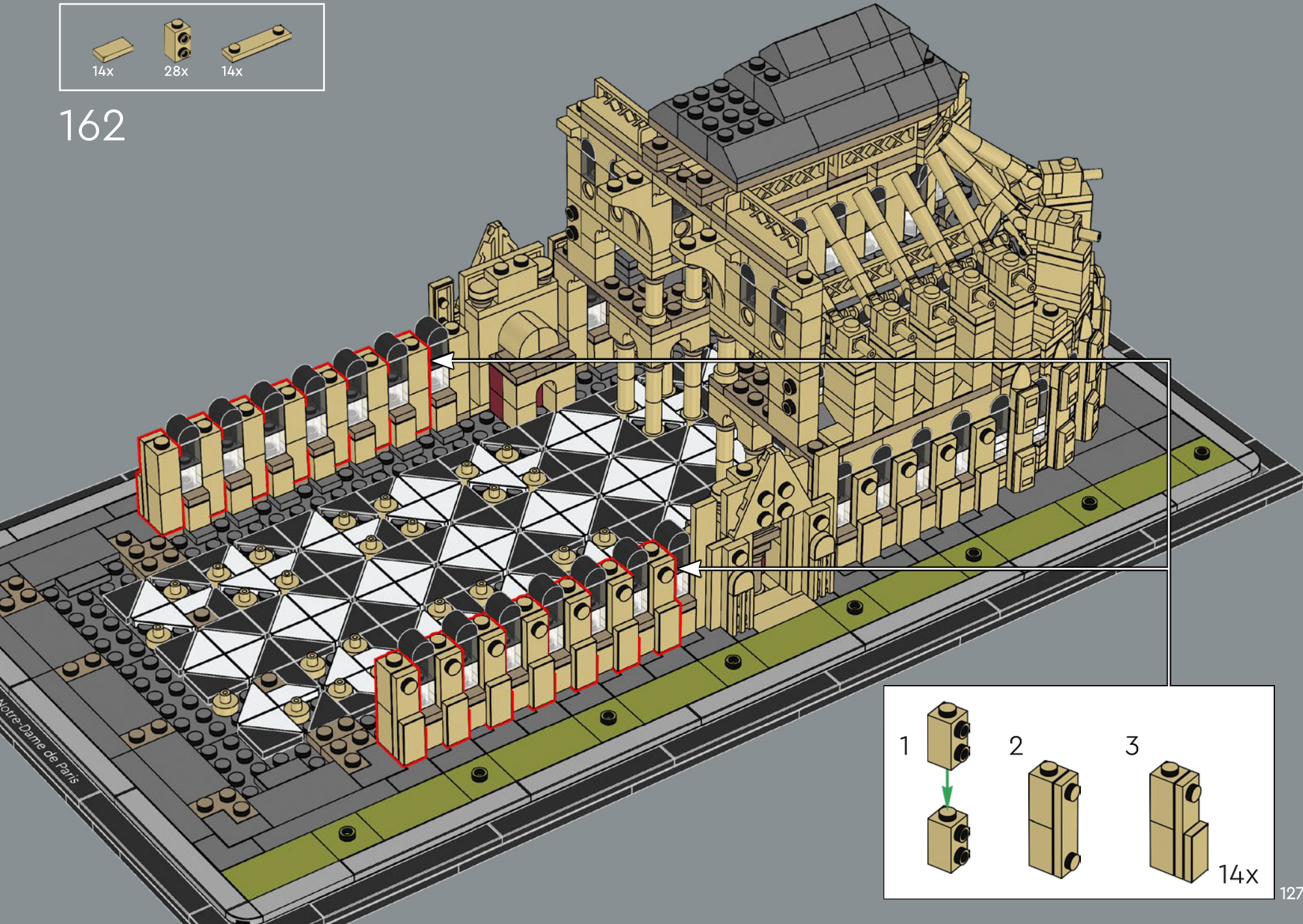



12x



4x

163





164

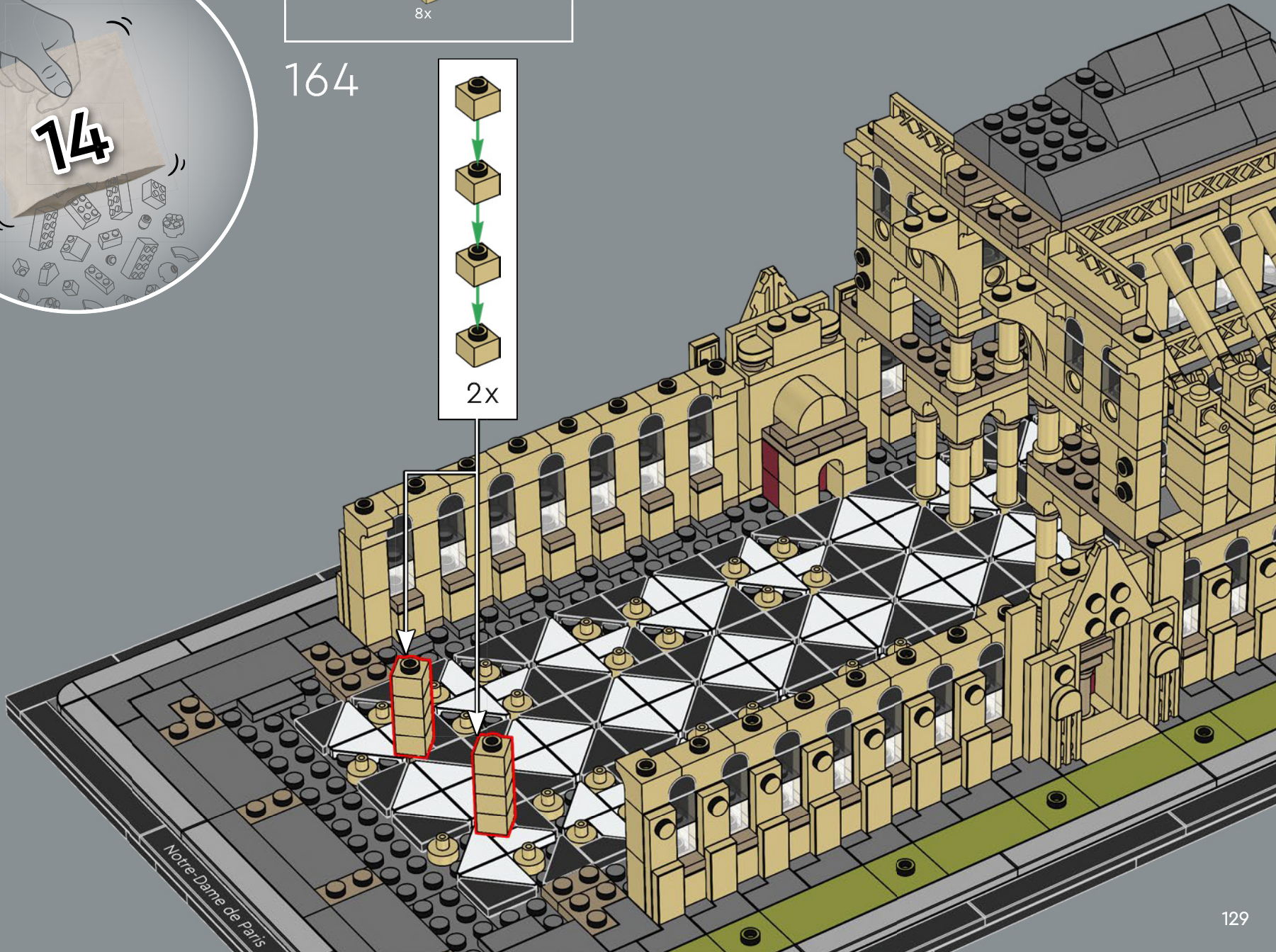
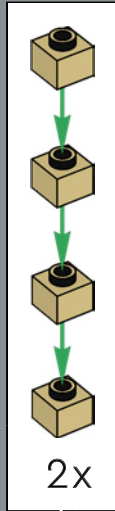



56x

165



28x

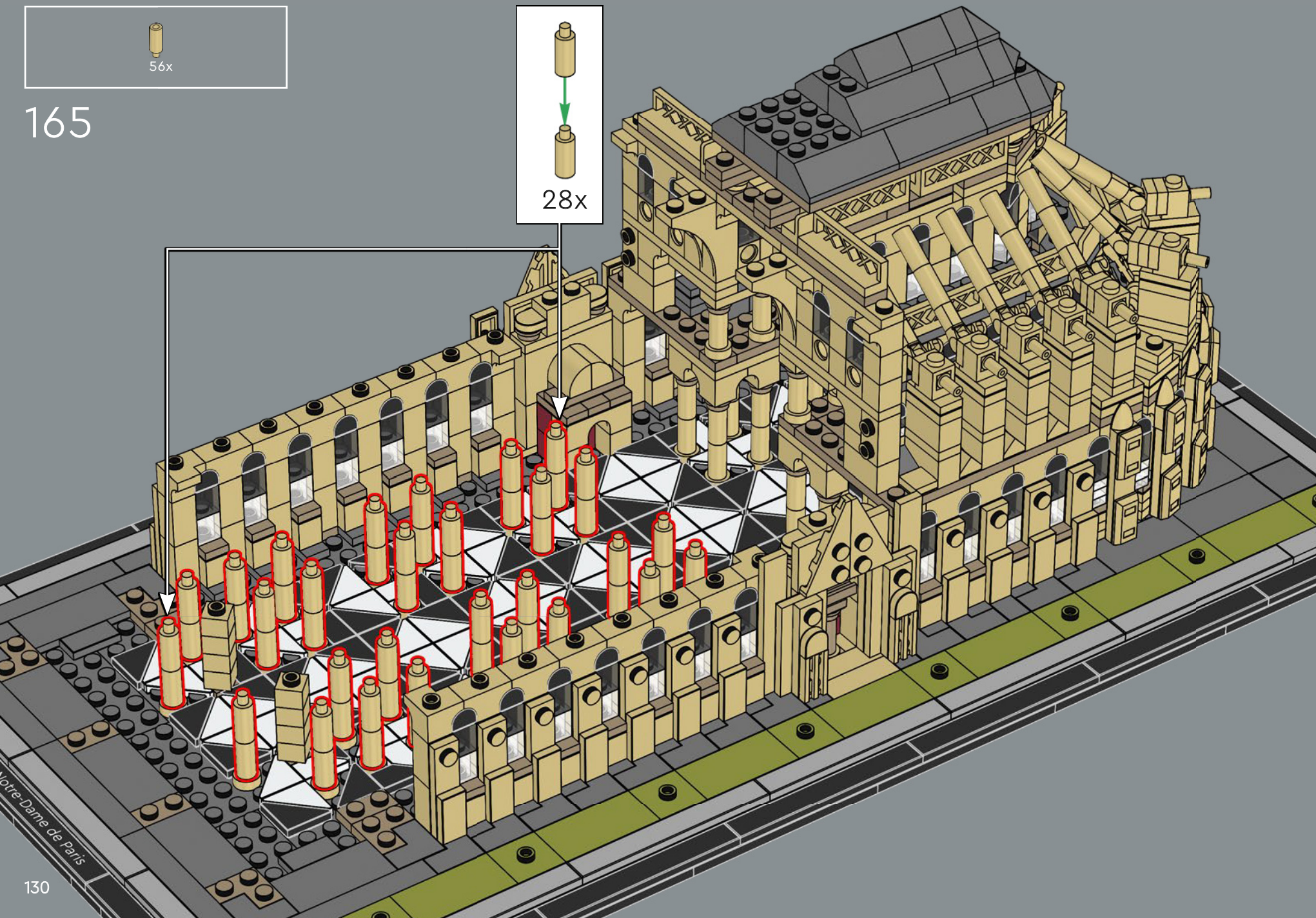

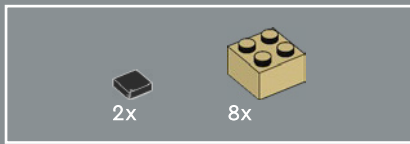

166

1208: Continúan los trabajos en la nave principal y se colocan los cimientos de las grandes torres del lado occidental.

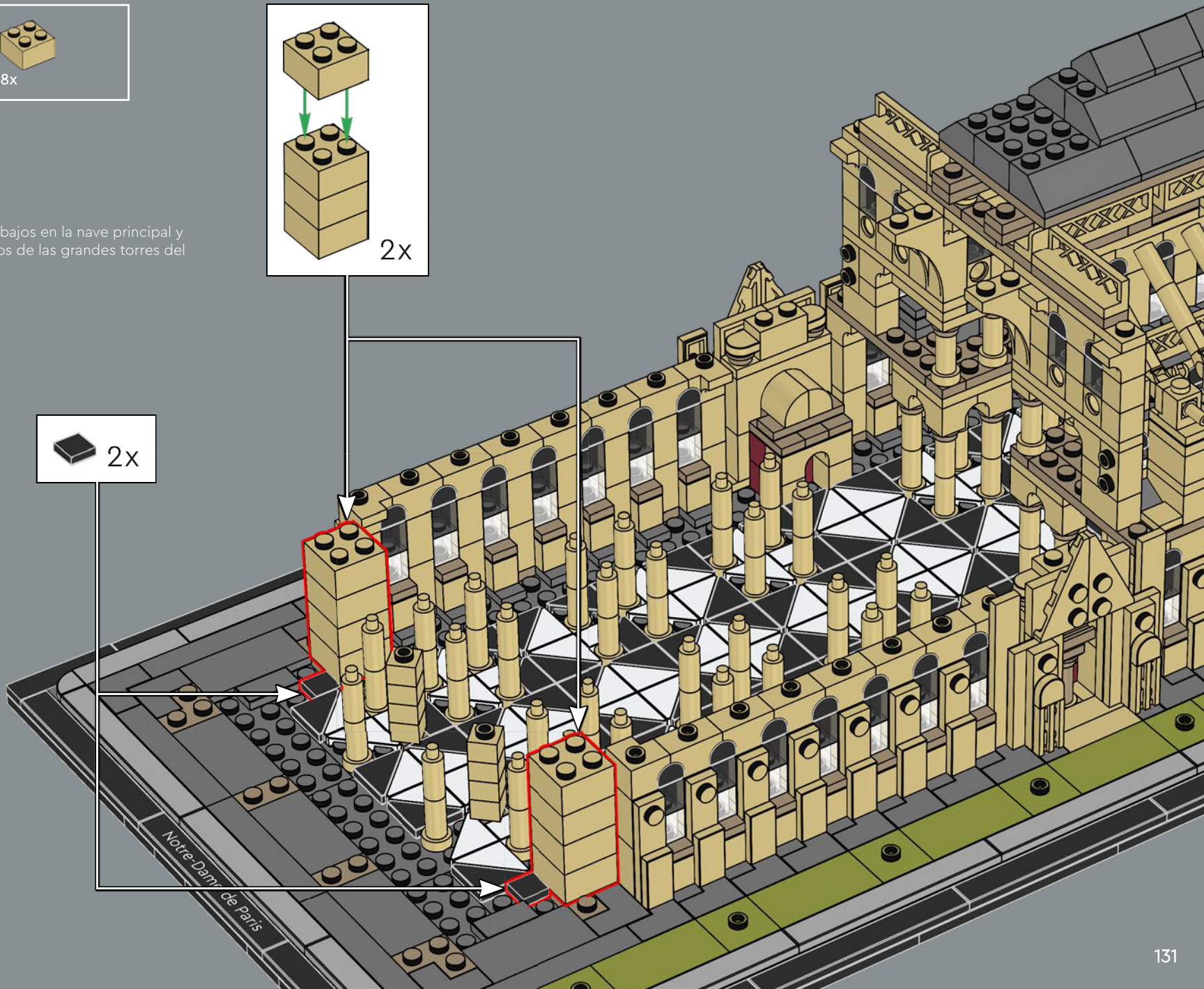
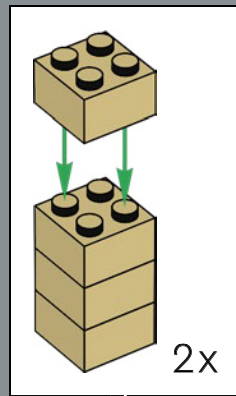

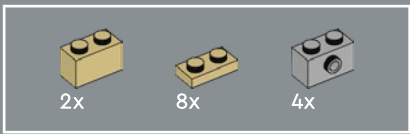

167

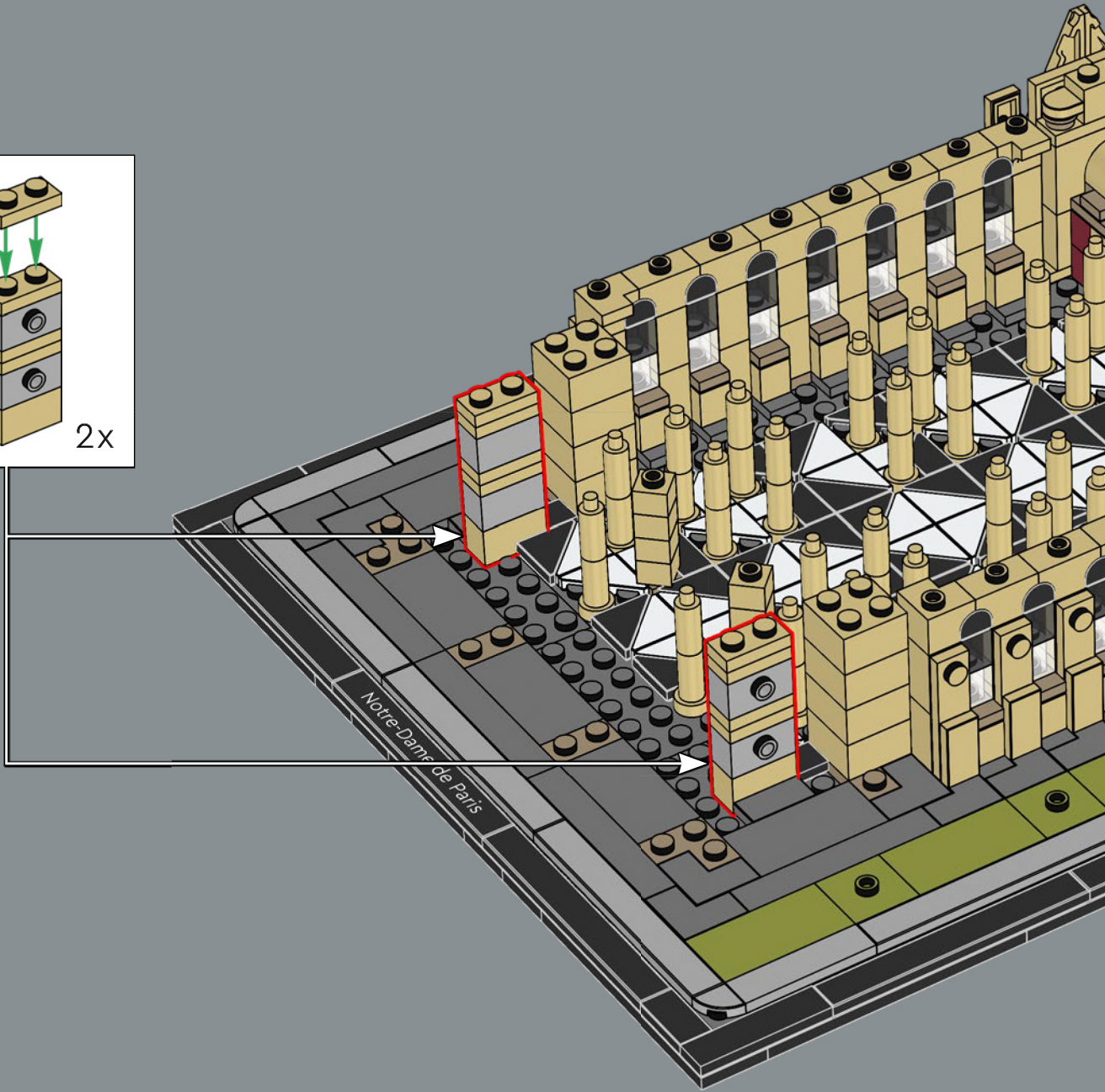
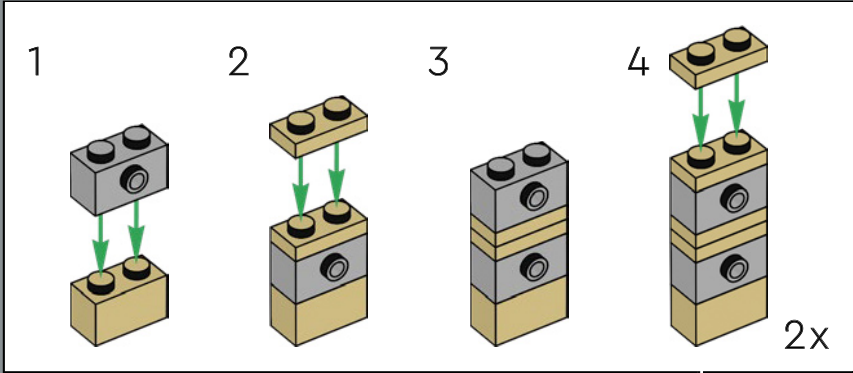

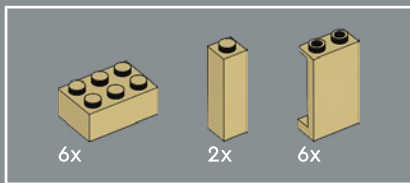

168

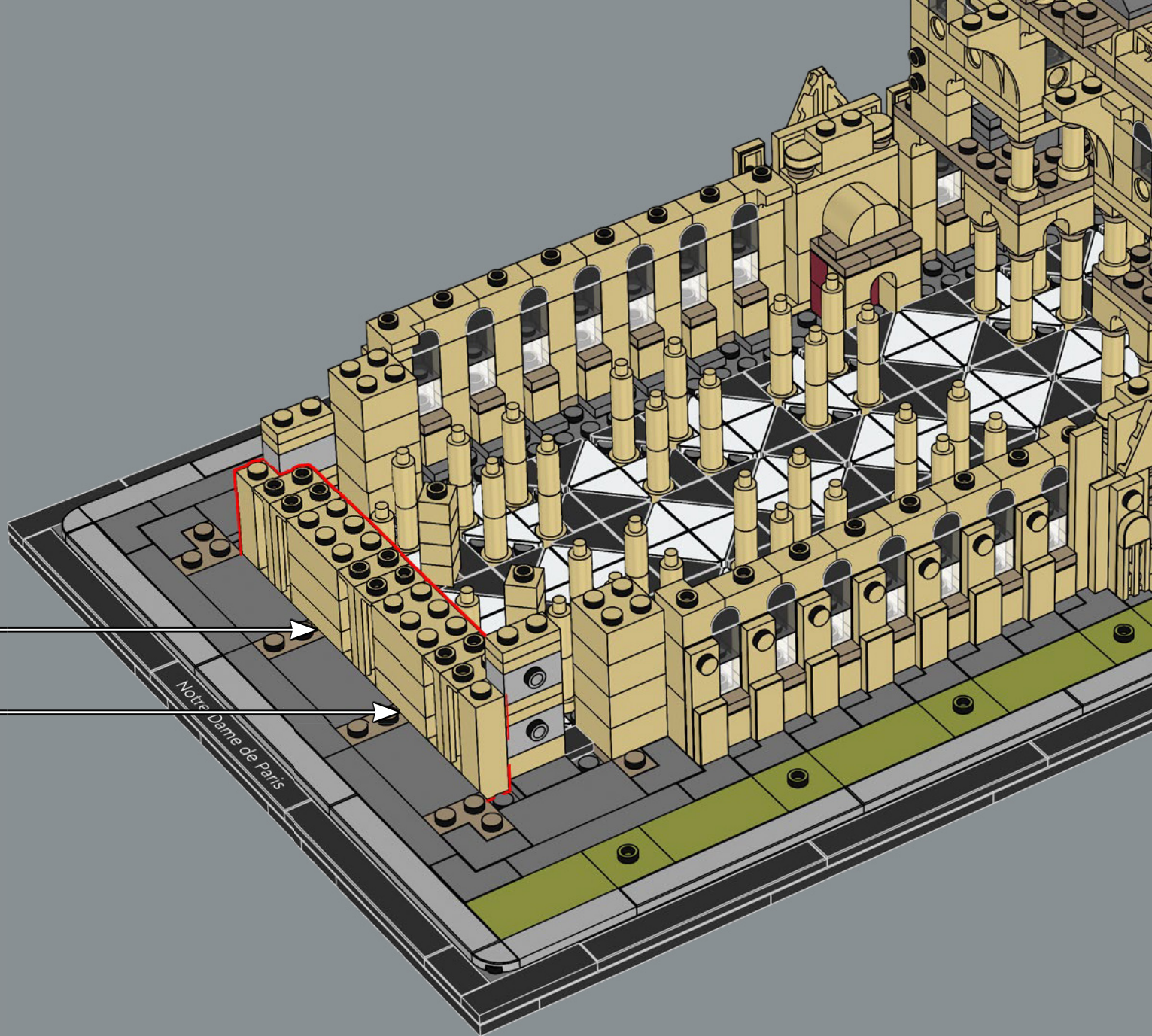
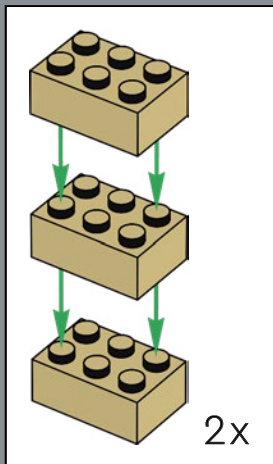

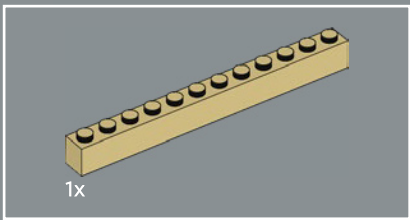

169

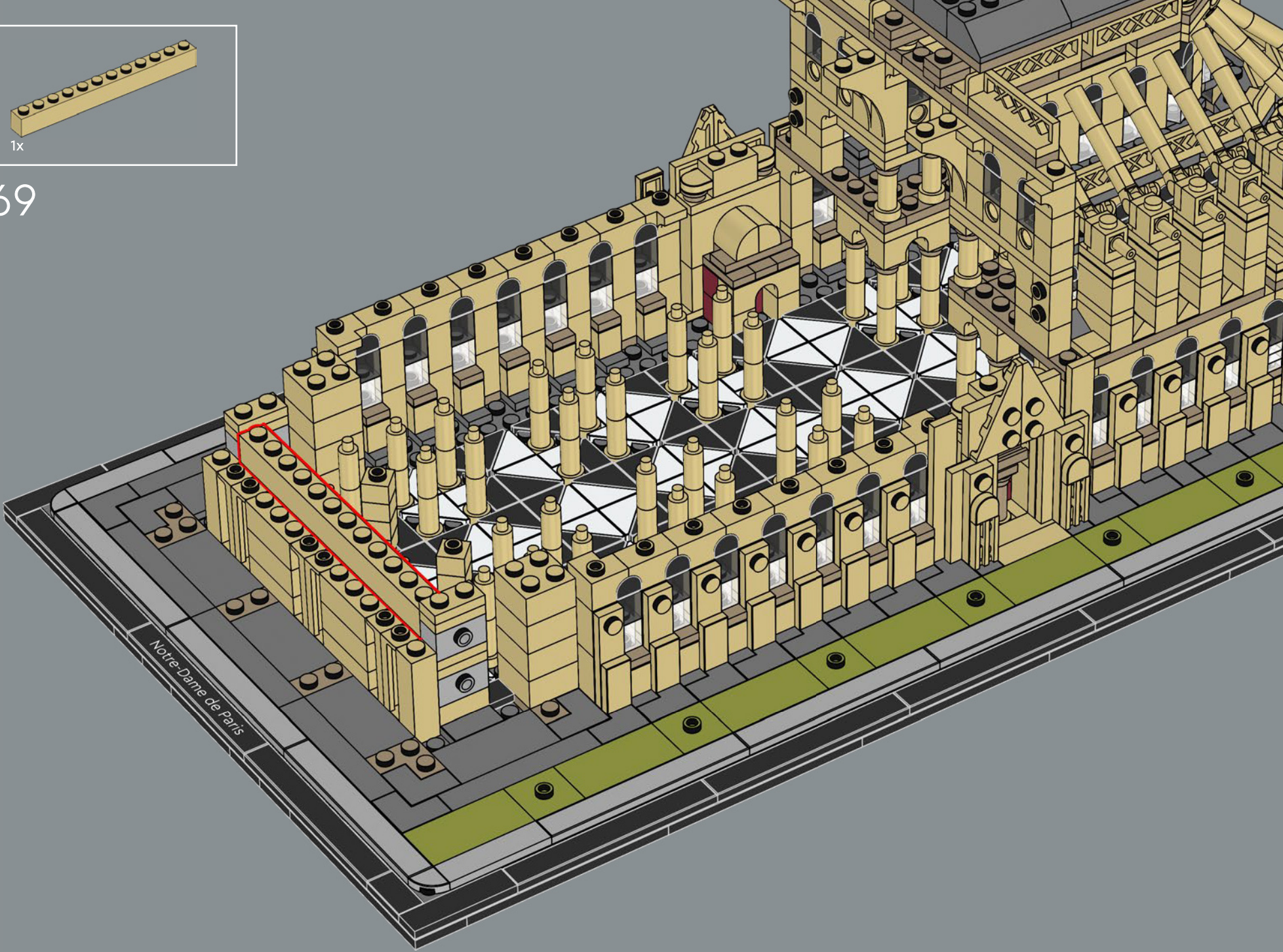

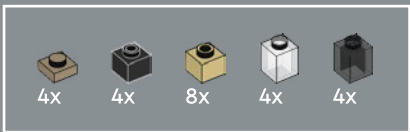

170

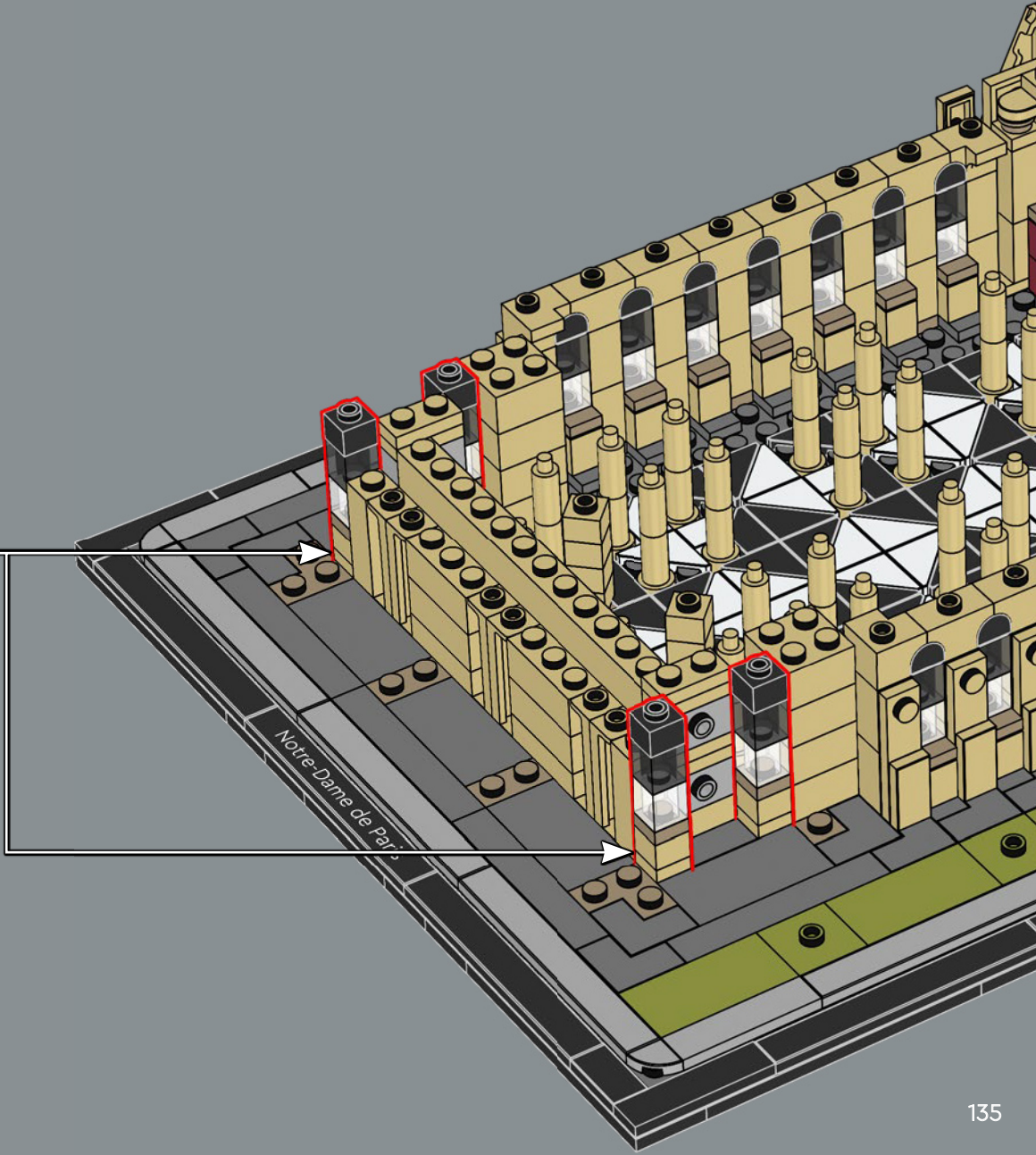
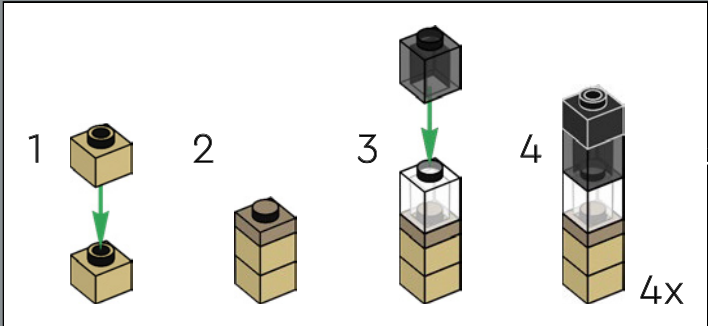

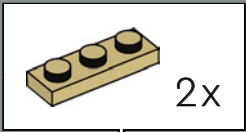
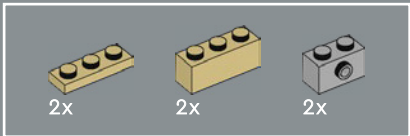

171



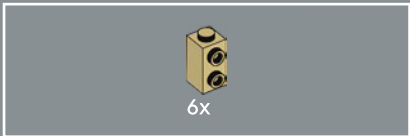

172

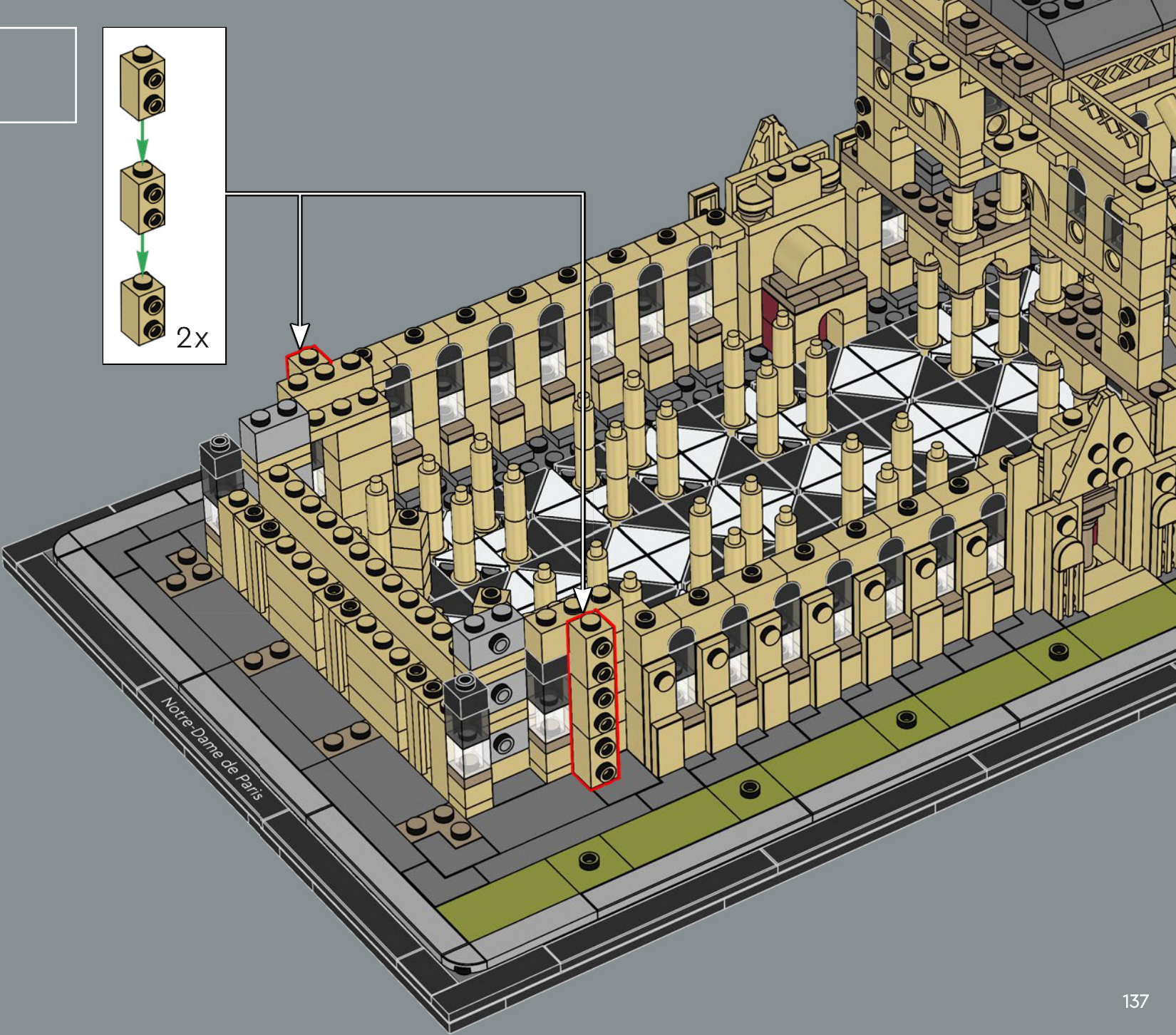
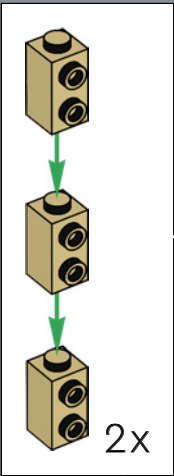

TÉCNICAS DE CONSTRUCCIÓN Y CARACTERÍSTICAS

✂ En 1208 se completó la construcción de la nave transversal, con sus grandes y singulares rosetones en las fachadas que presentan tamaños y diseños distintos. El rosetón septentrional original tiene un diámetro de 13,5 m, todo un hito para su época. Cada uno de los elementos arquitectónicos de la catedral cumple una función, tanto en el sentido decorativo como en el práctico. Los tres rosetones del modelo LEGO® son una abstracción de los originales: todos tienen el mismo tamaño y diseño, y puedes utilizarlos indistintamente en el modelo. En 1220 ya se había completado el cuerpo de la catedral a excepción de la parte superior de las torres.



Las inconfundibles gárgolas tienen la función de evacuar el agua de lluvia para proteger la catedral de los daños que podría causar una escorrentía excesiva. Esta característica también se reproduce en el modelo.



173

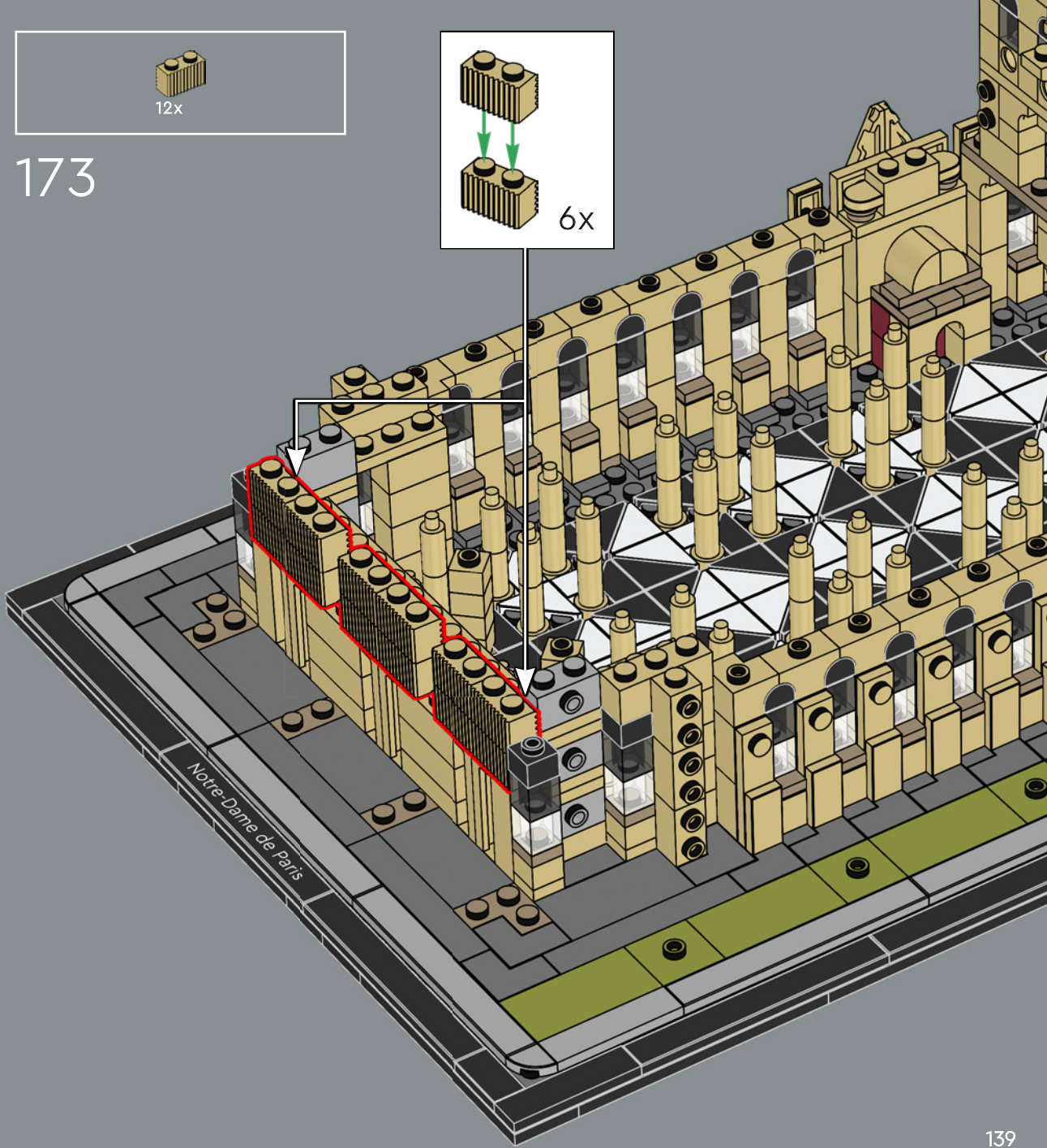
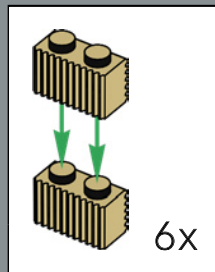

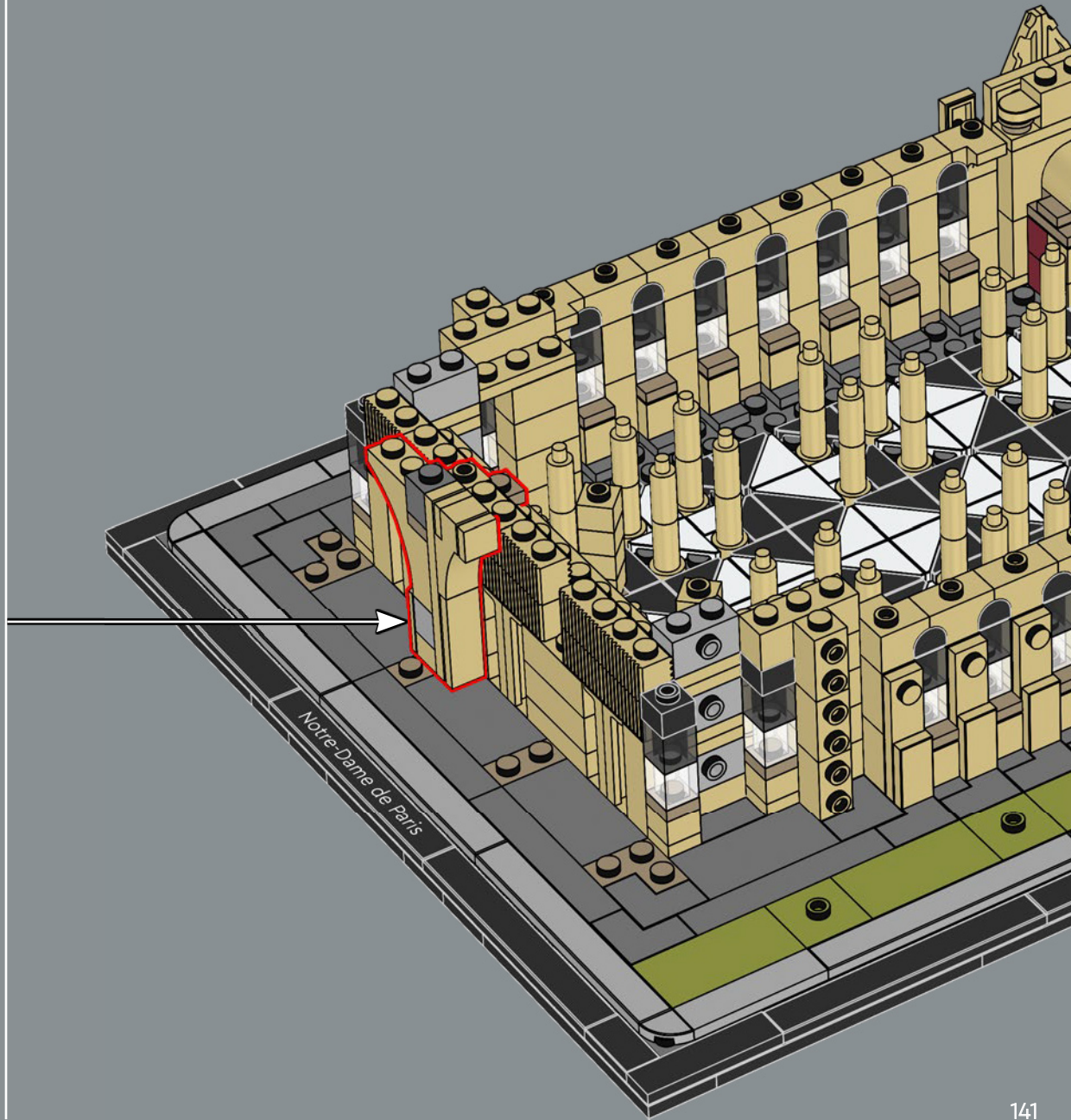
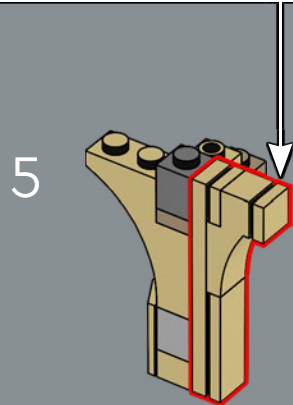
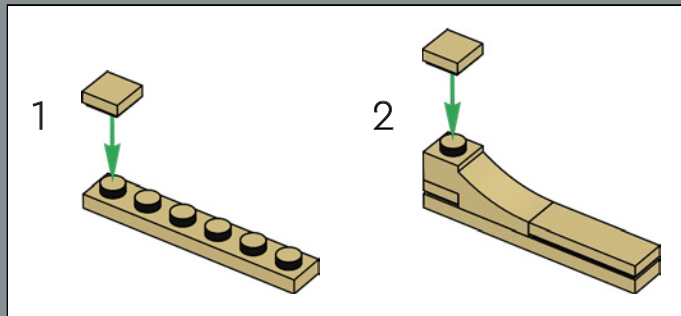

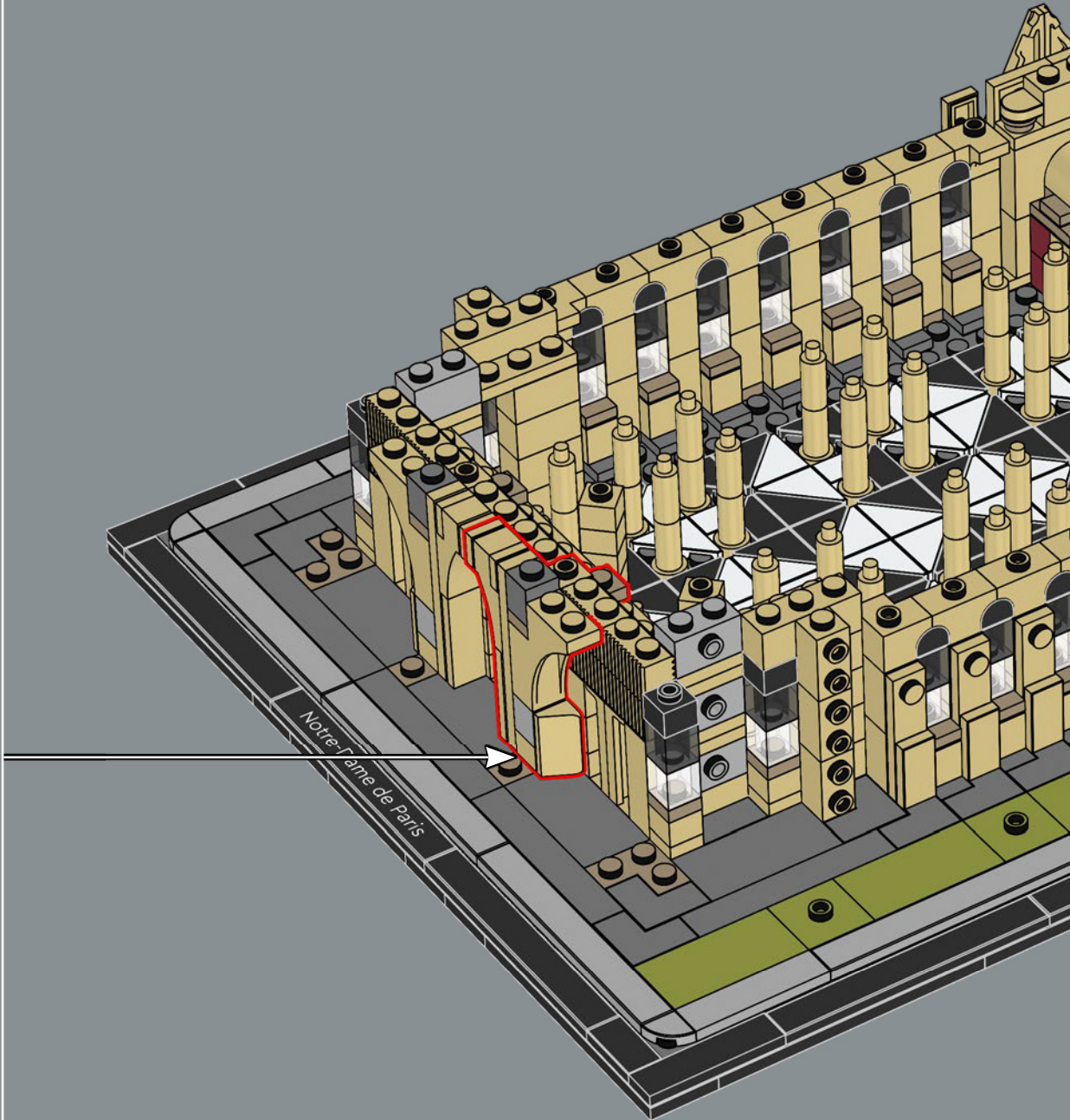
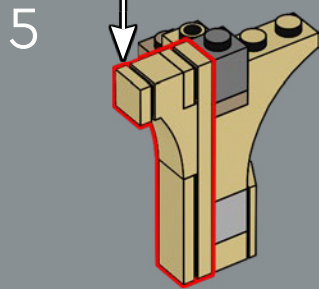
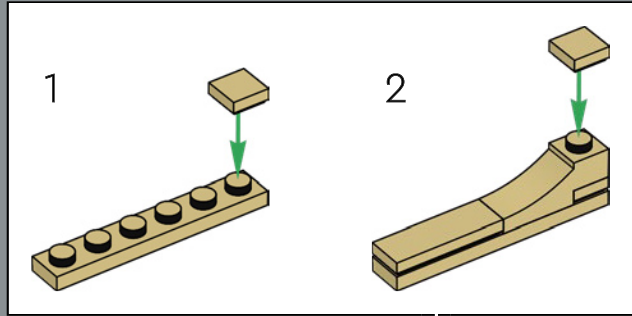

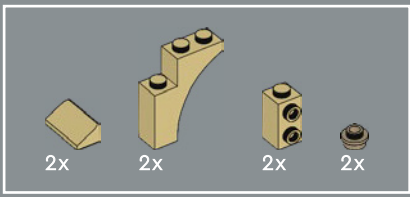

176

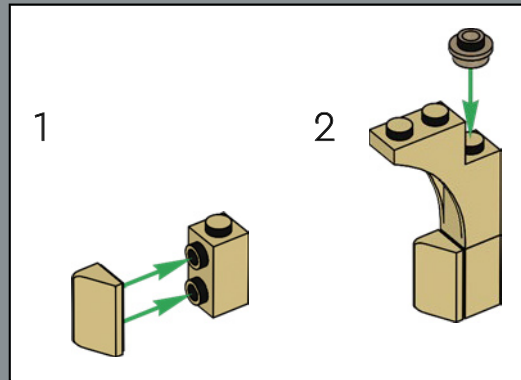
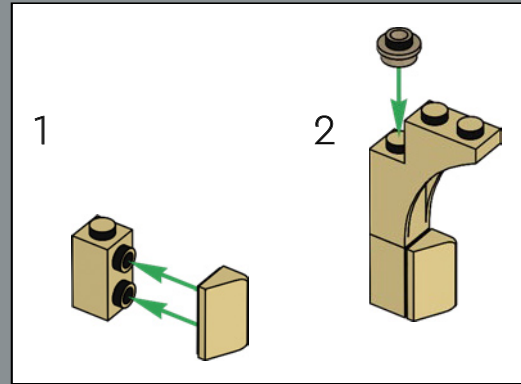

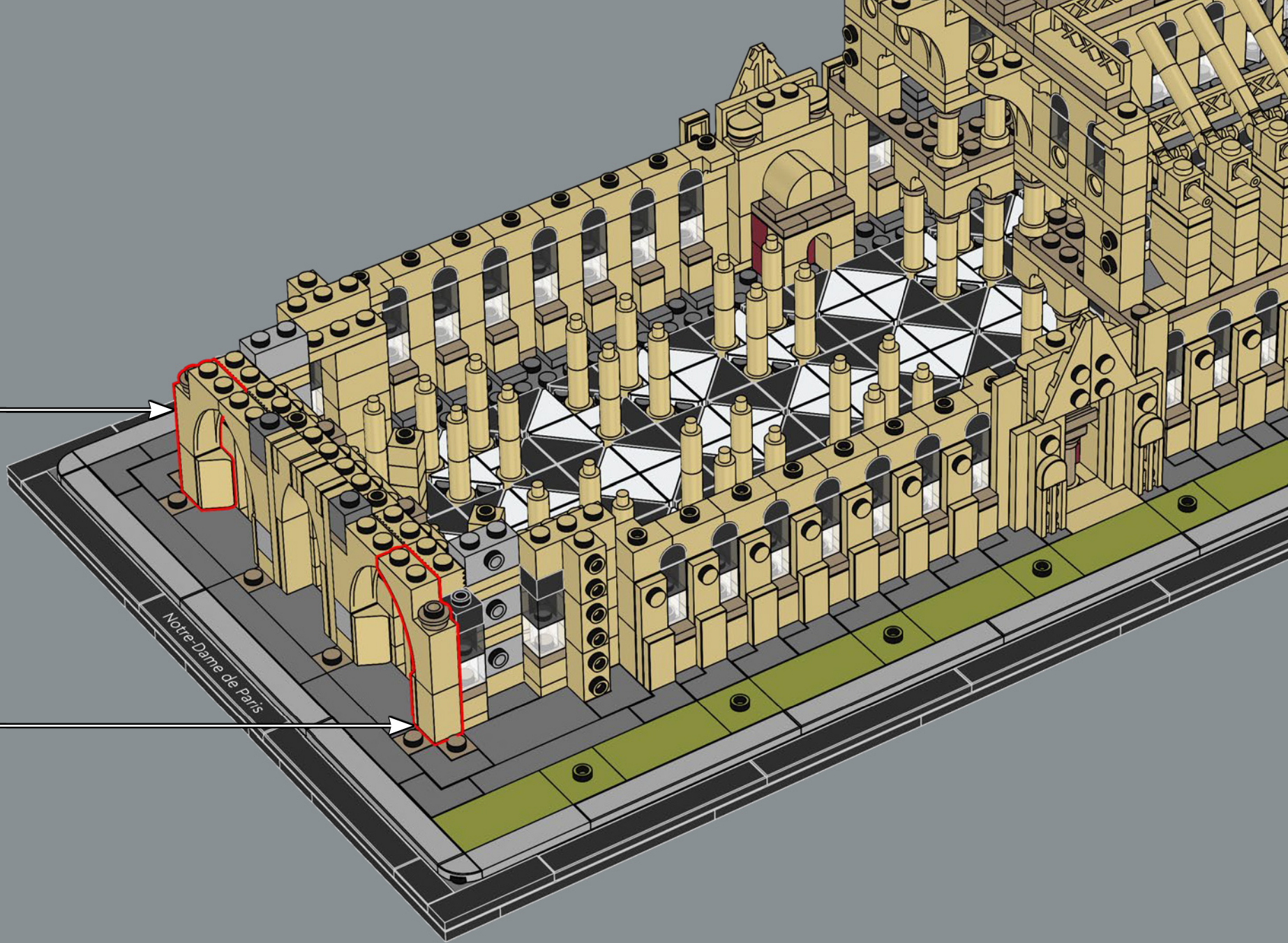

Notre-Dame de Paris

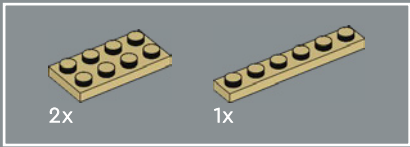

177



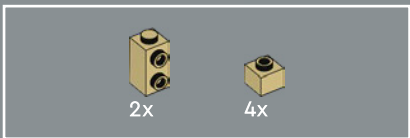

178

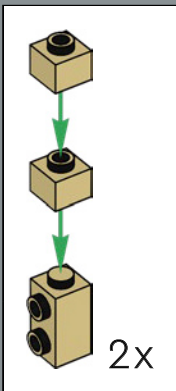

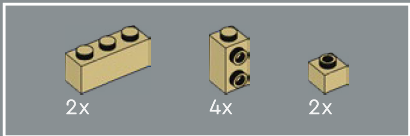

179

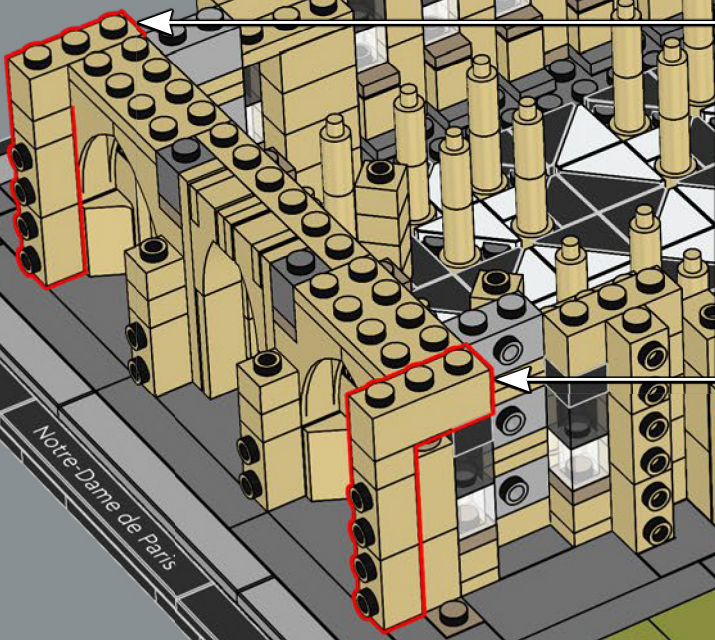
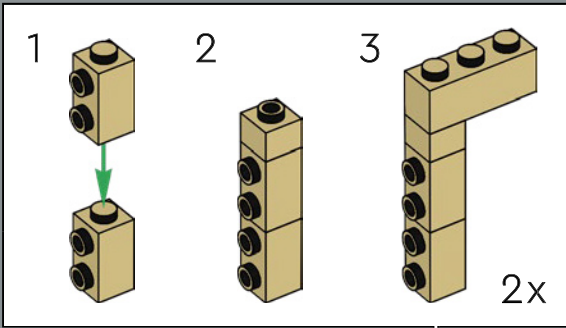

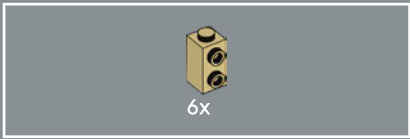

180

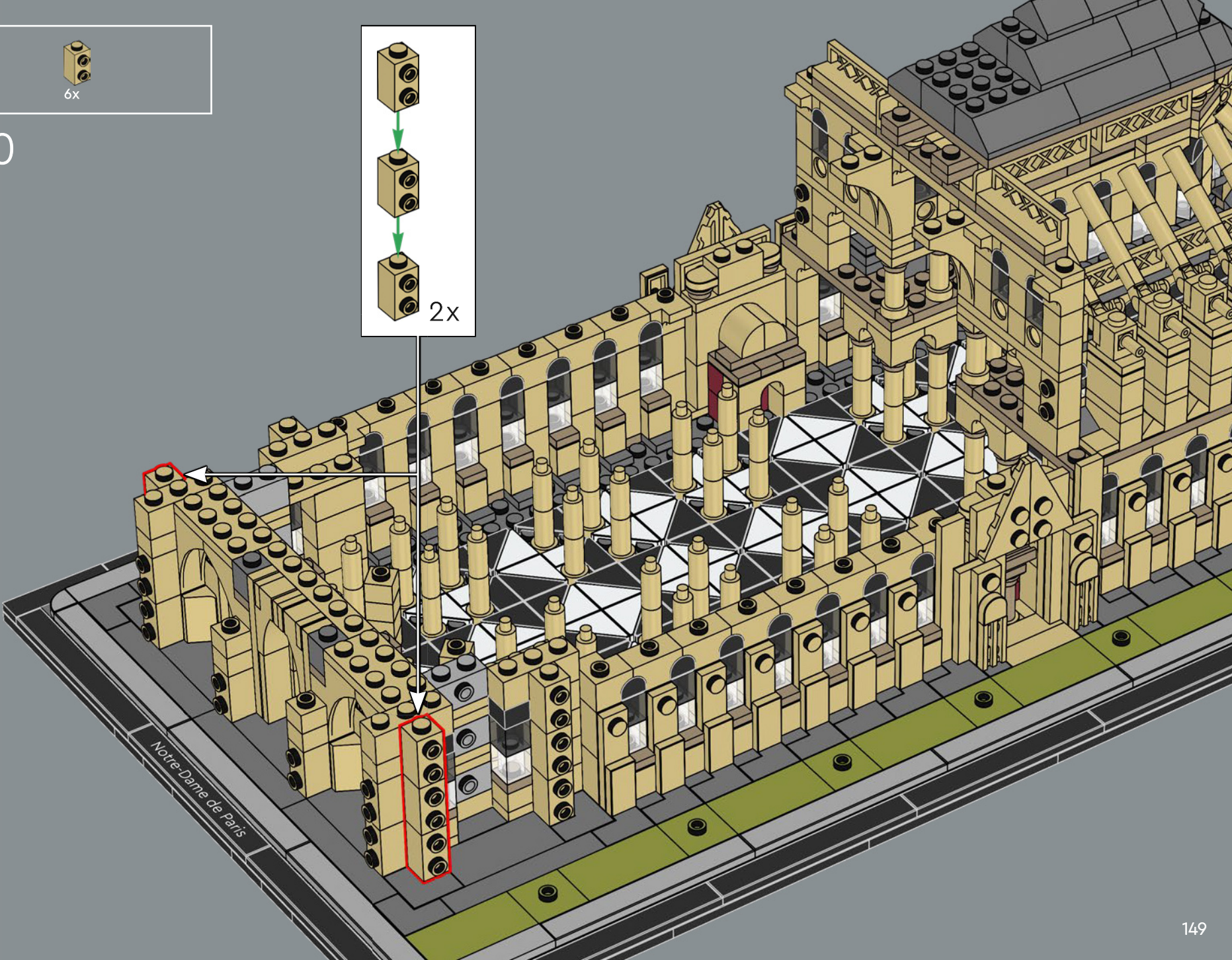
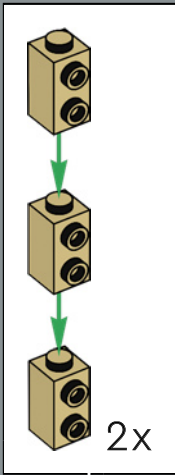

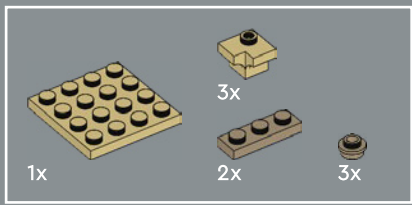

181

1

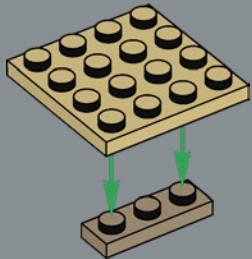

2

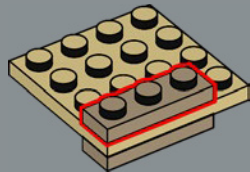

3

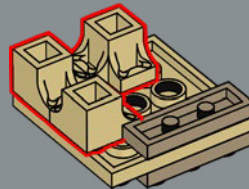

4

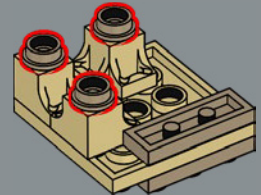

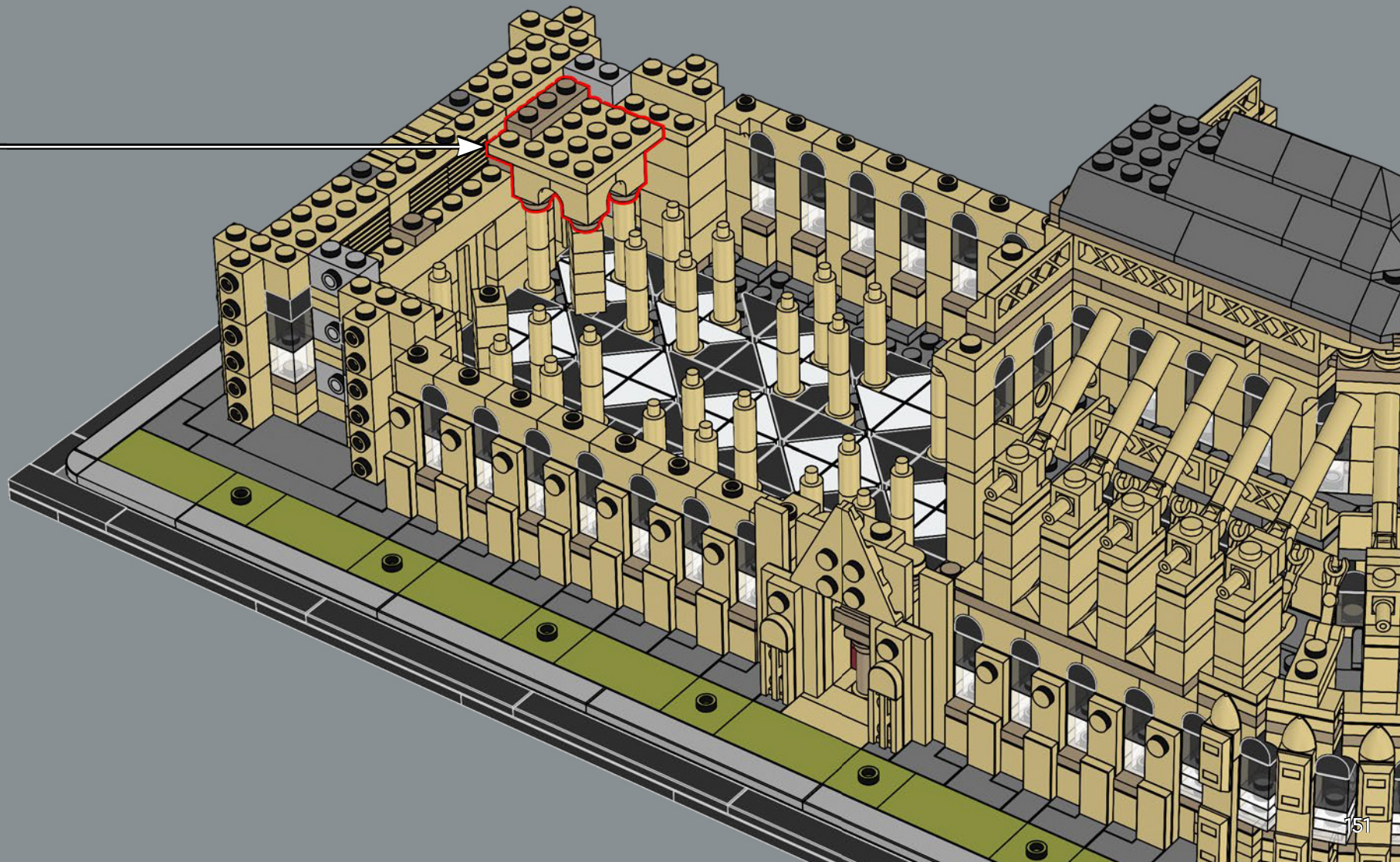

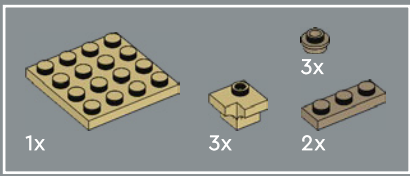

182

1

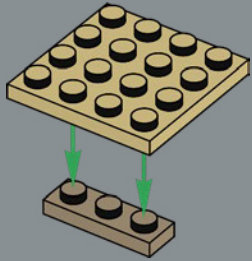

2

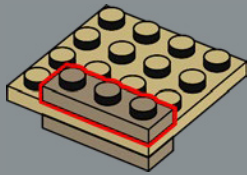

3

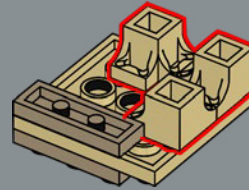

4

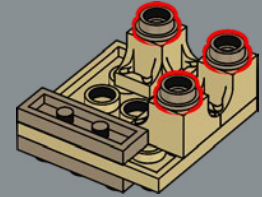



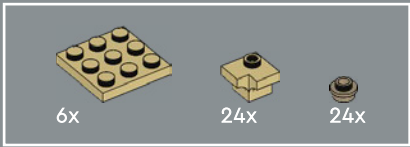

183

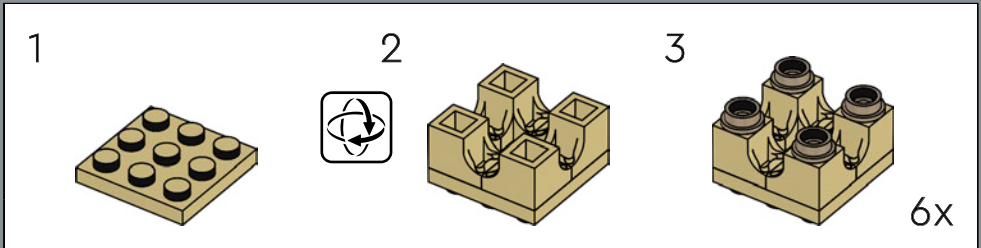

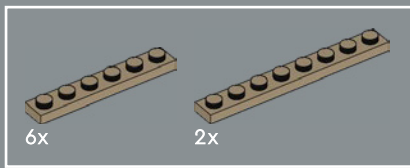



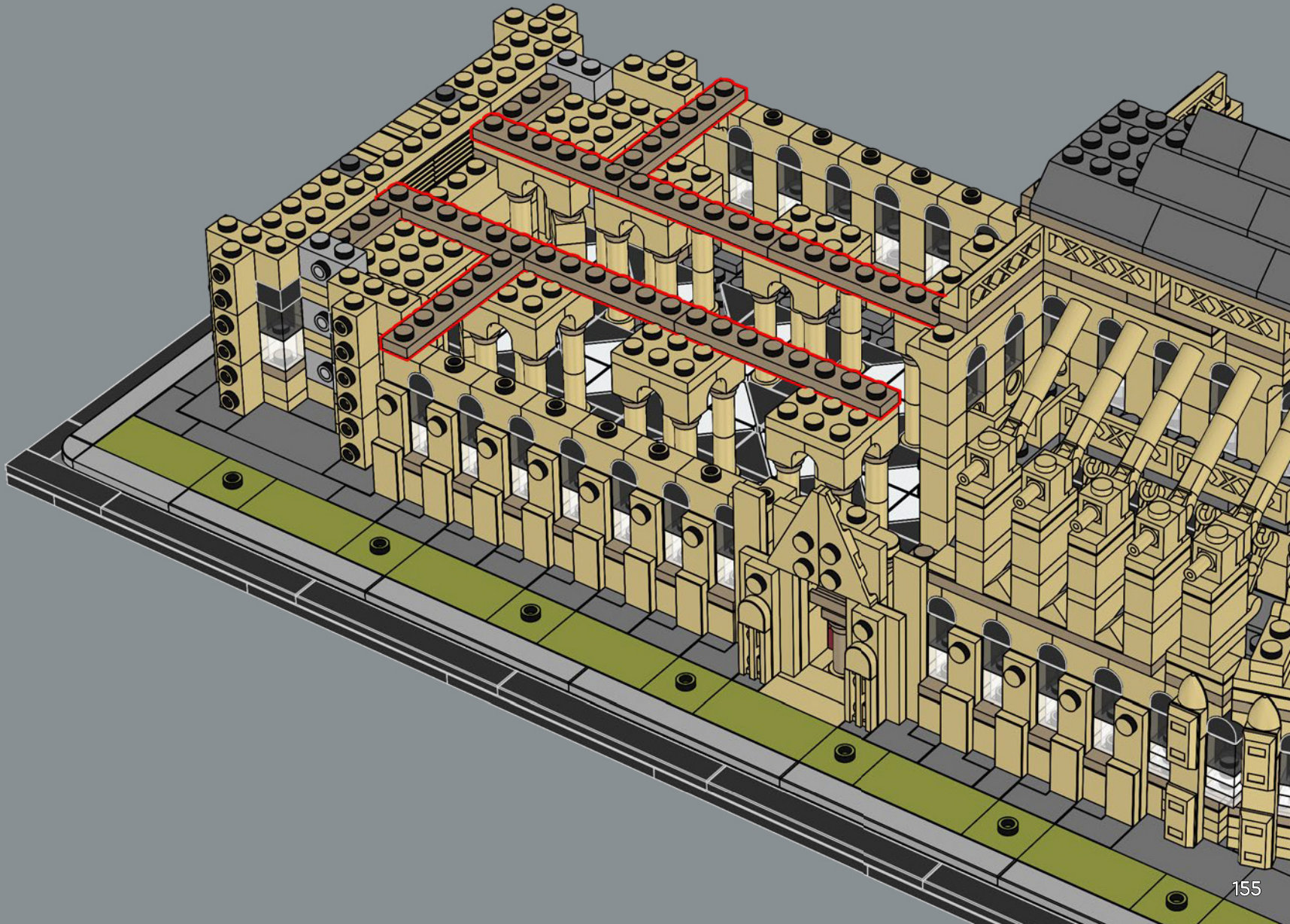

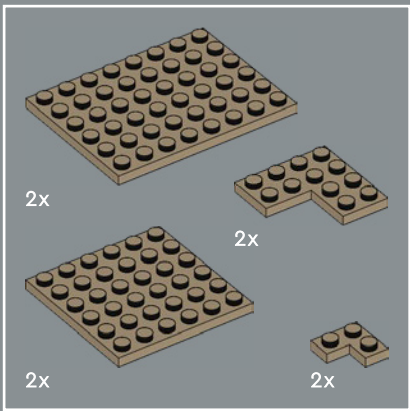
184



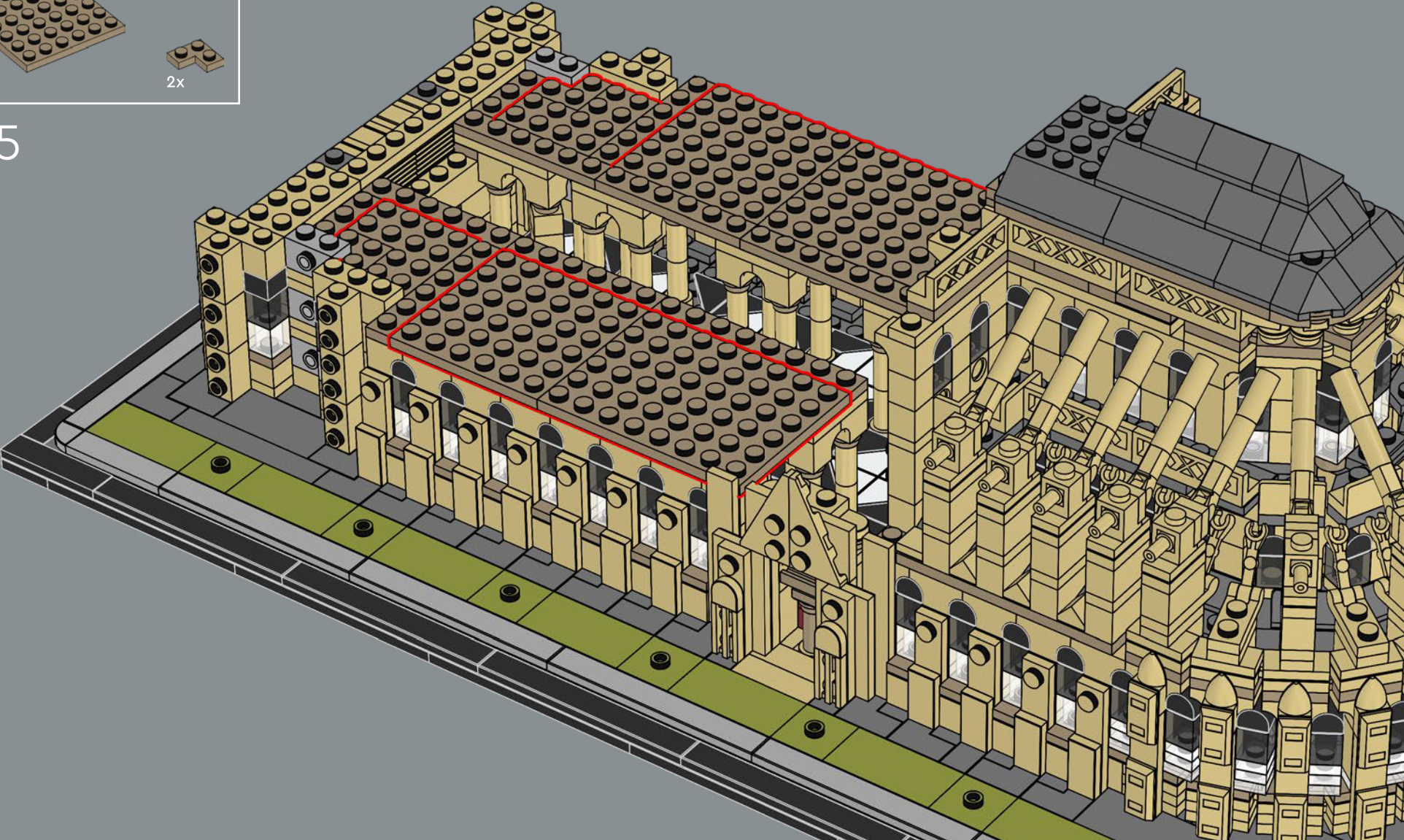

185



		
2x	2x	12x

186



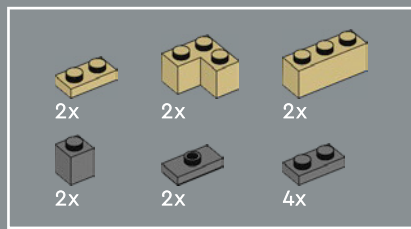

187

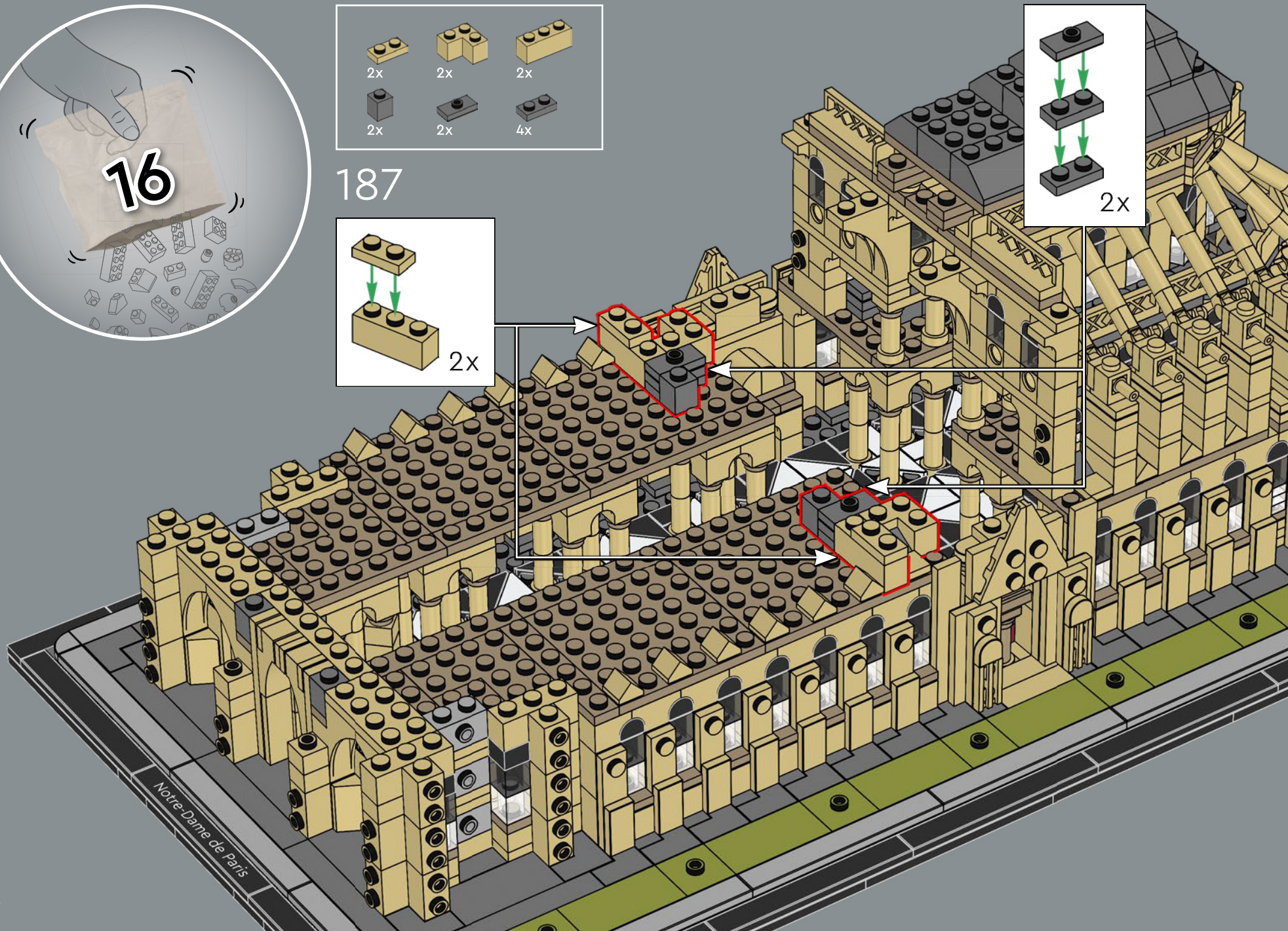
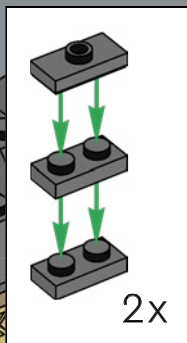
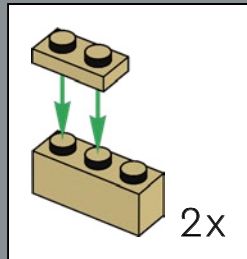

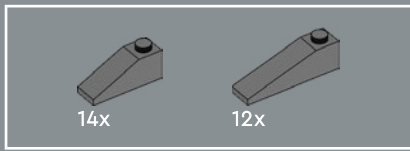

188

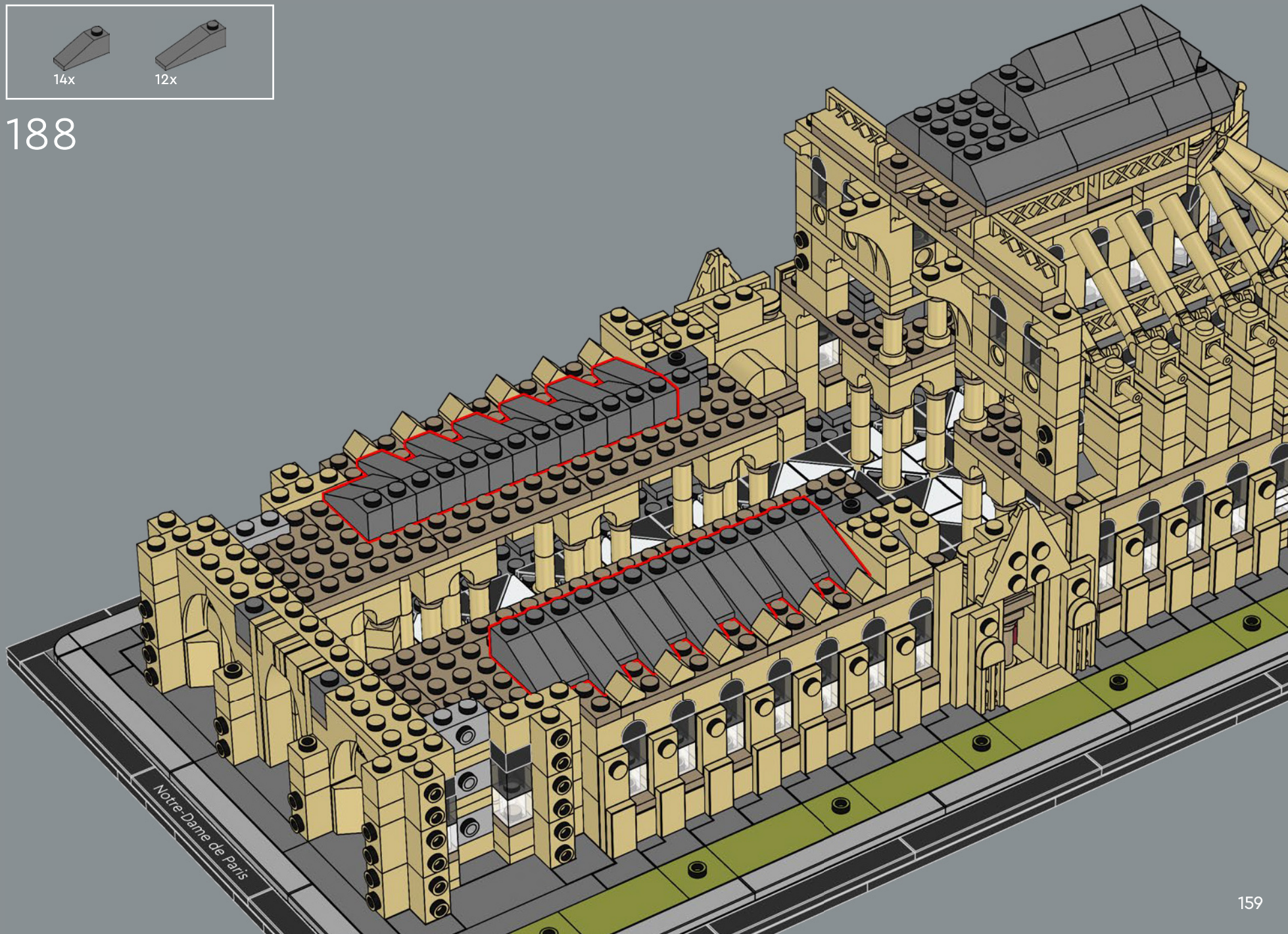

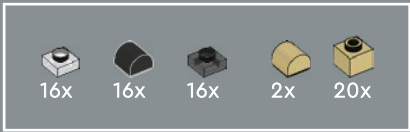

189

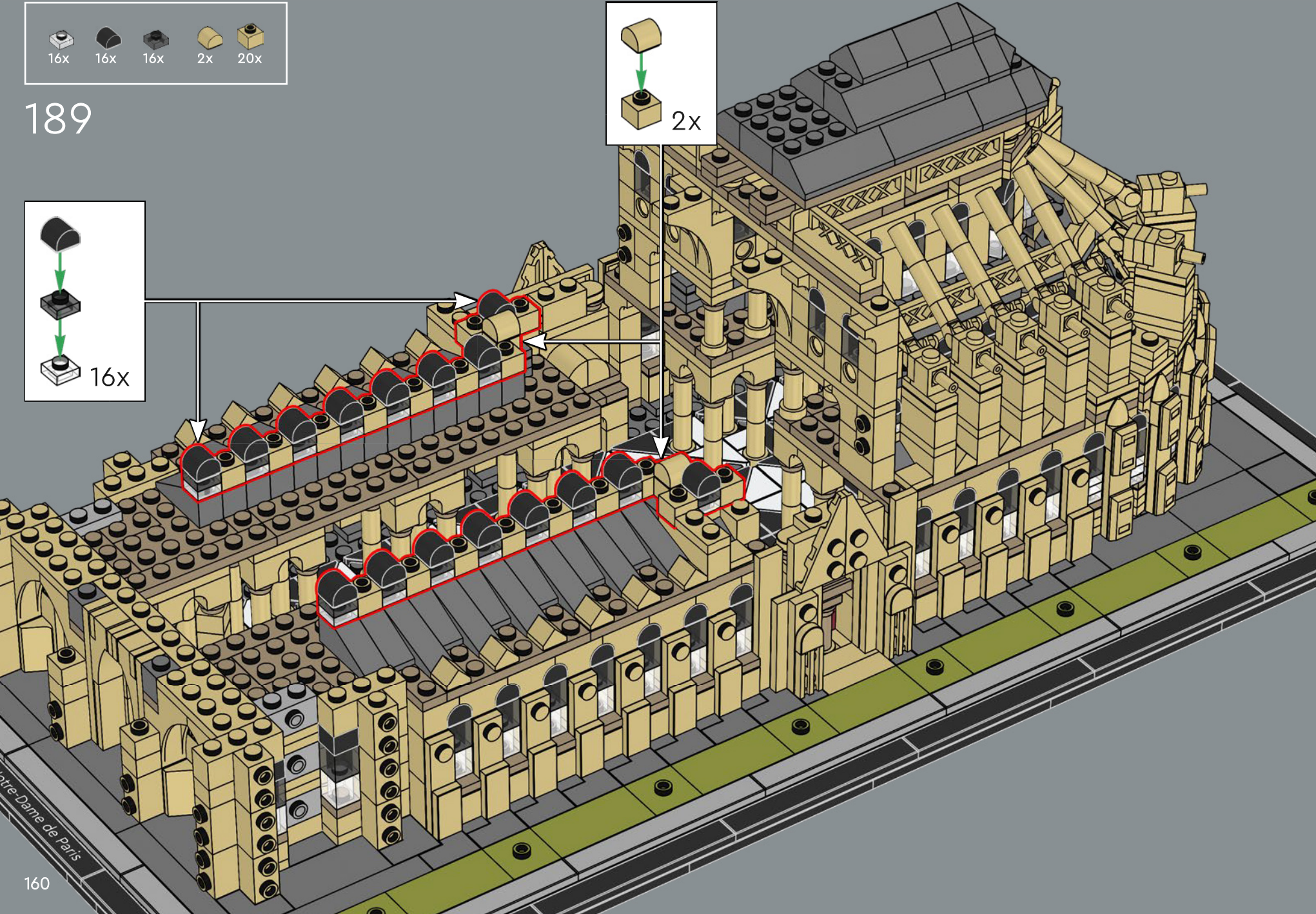
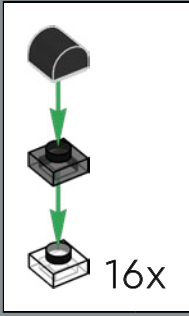
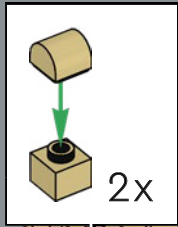

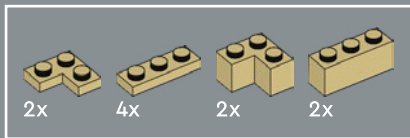

190

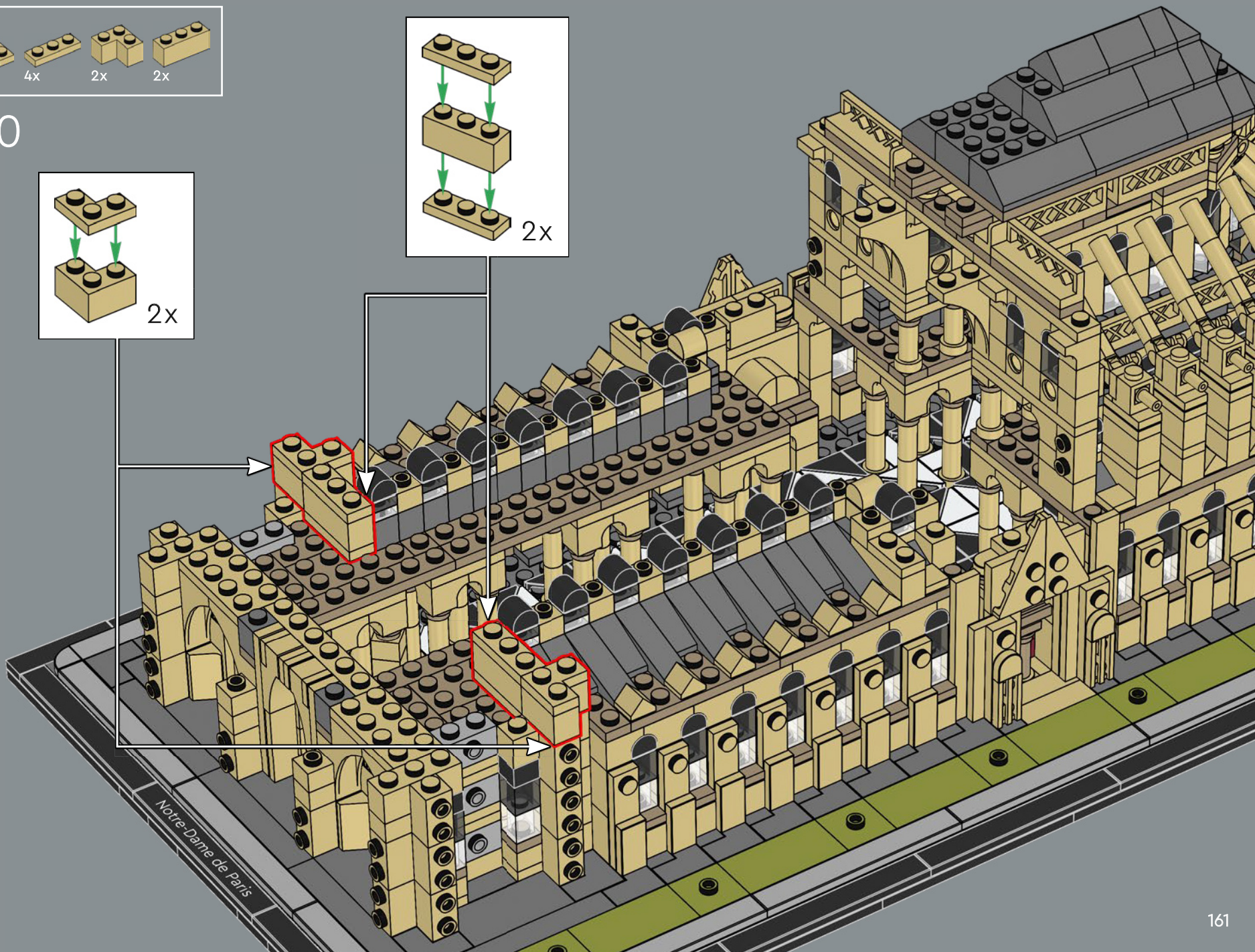
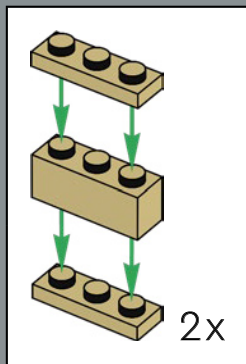
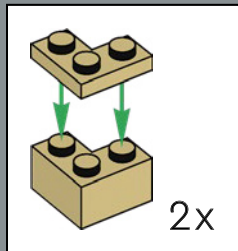

Notre-Dame de Paris



6x

191

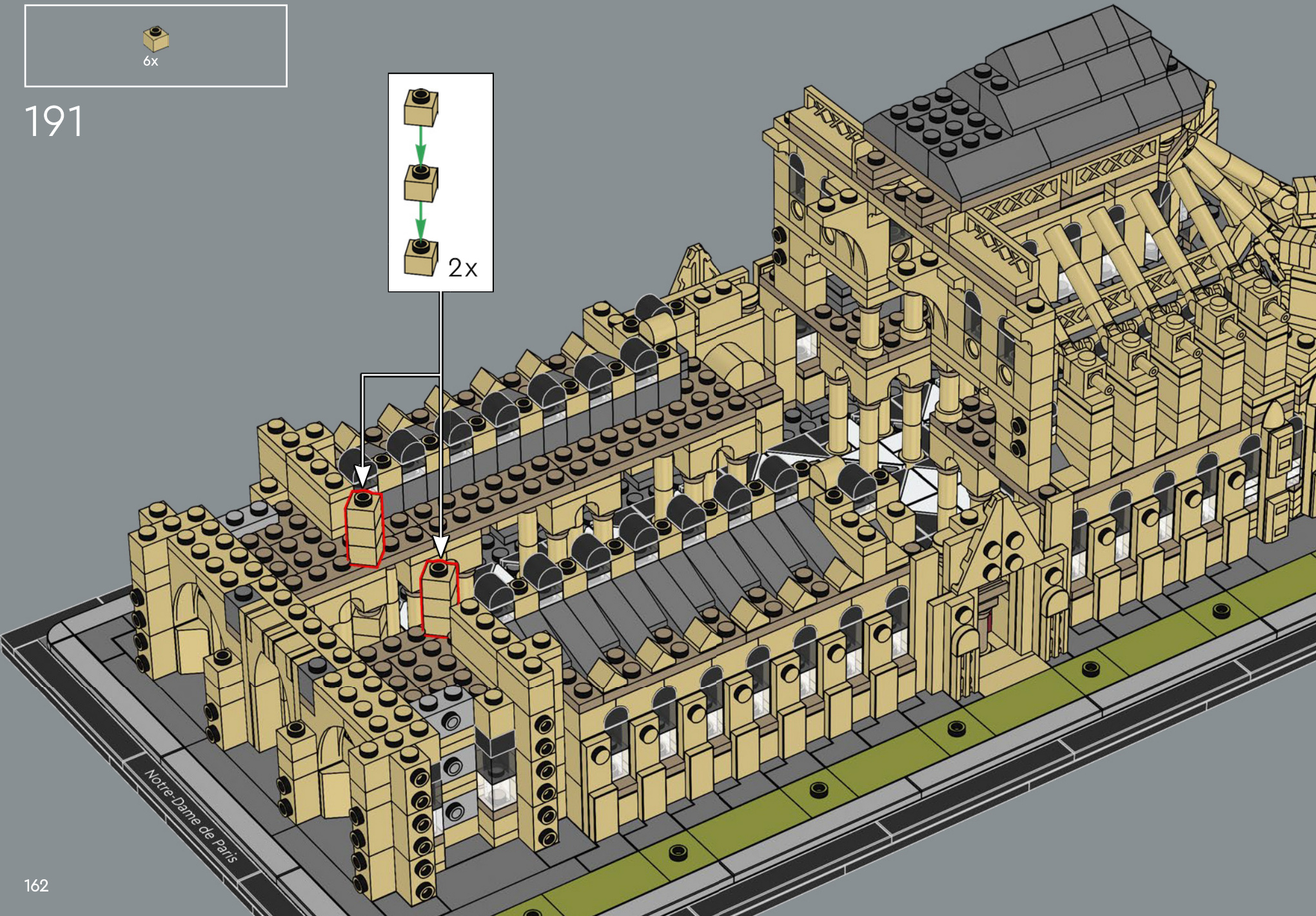
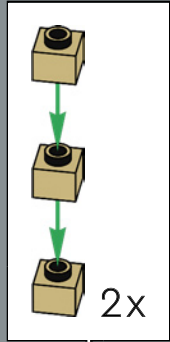

Notre-Dame de Paris

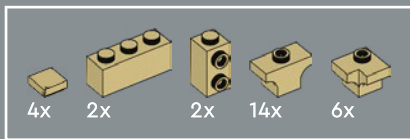

192

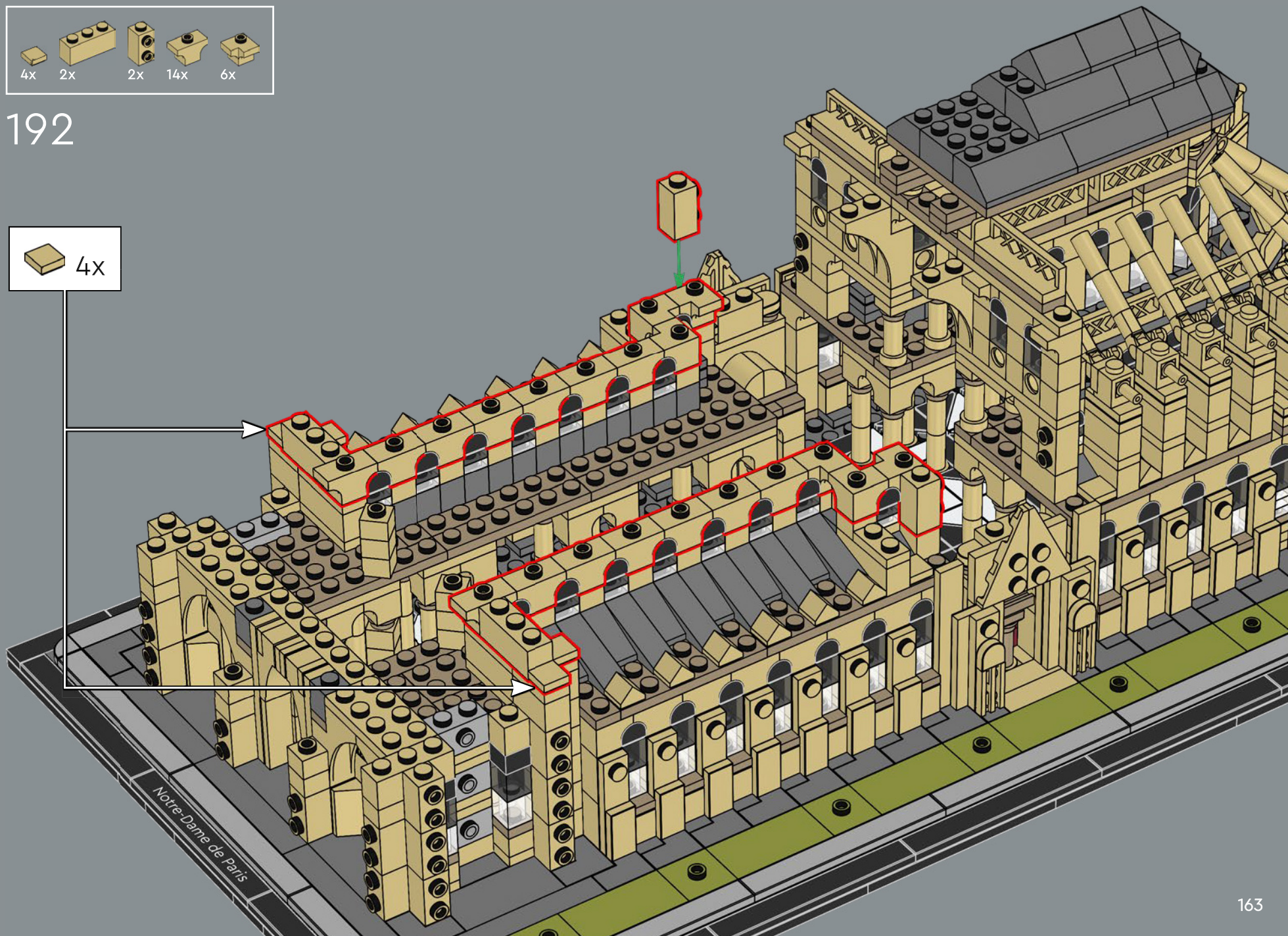

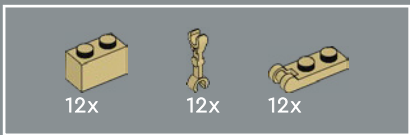

193

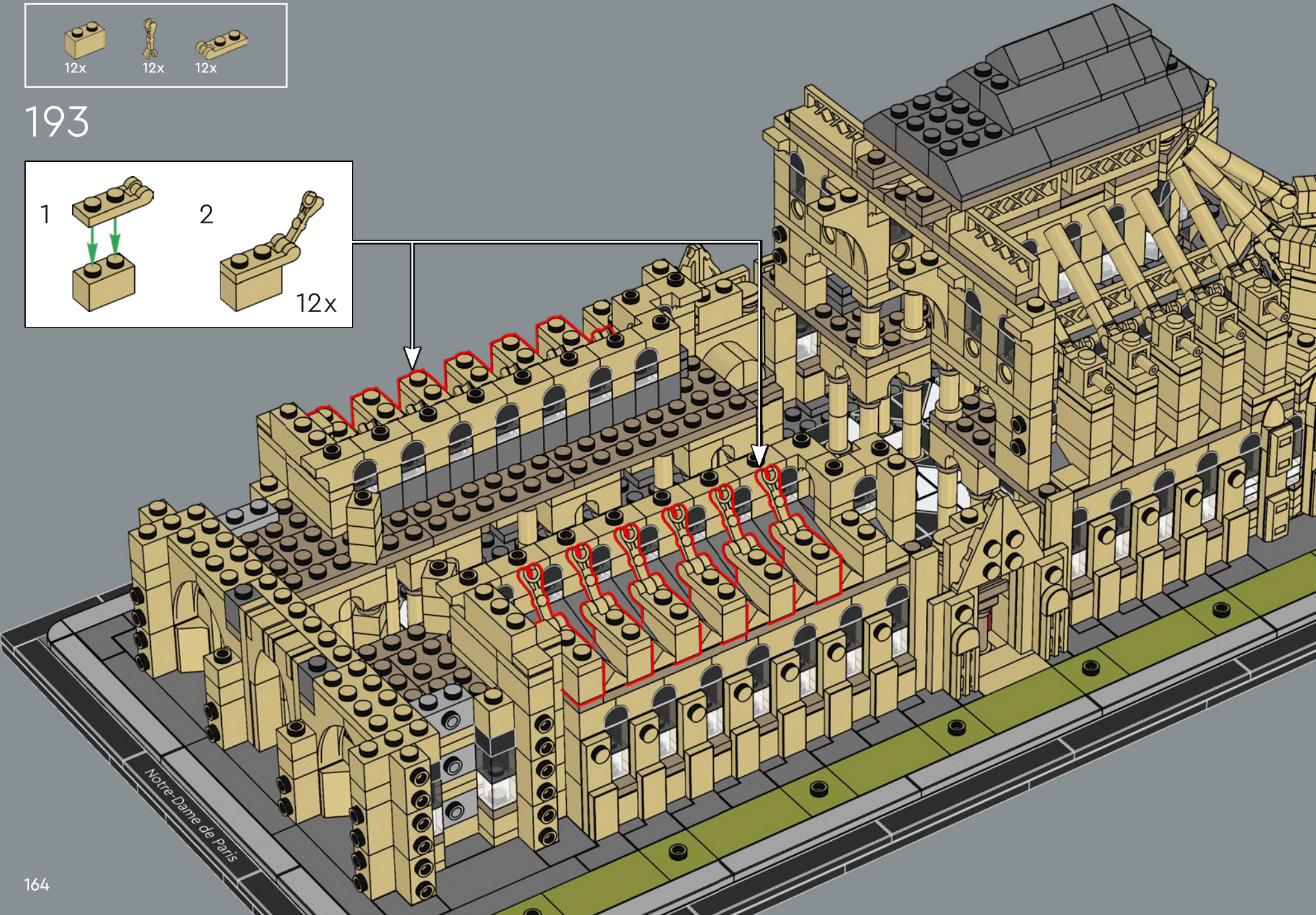
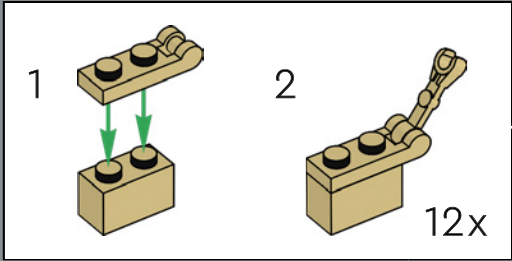



194

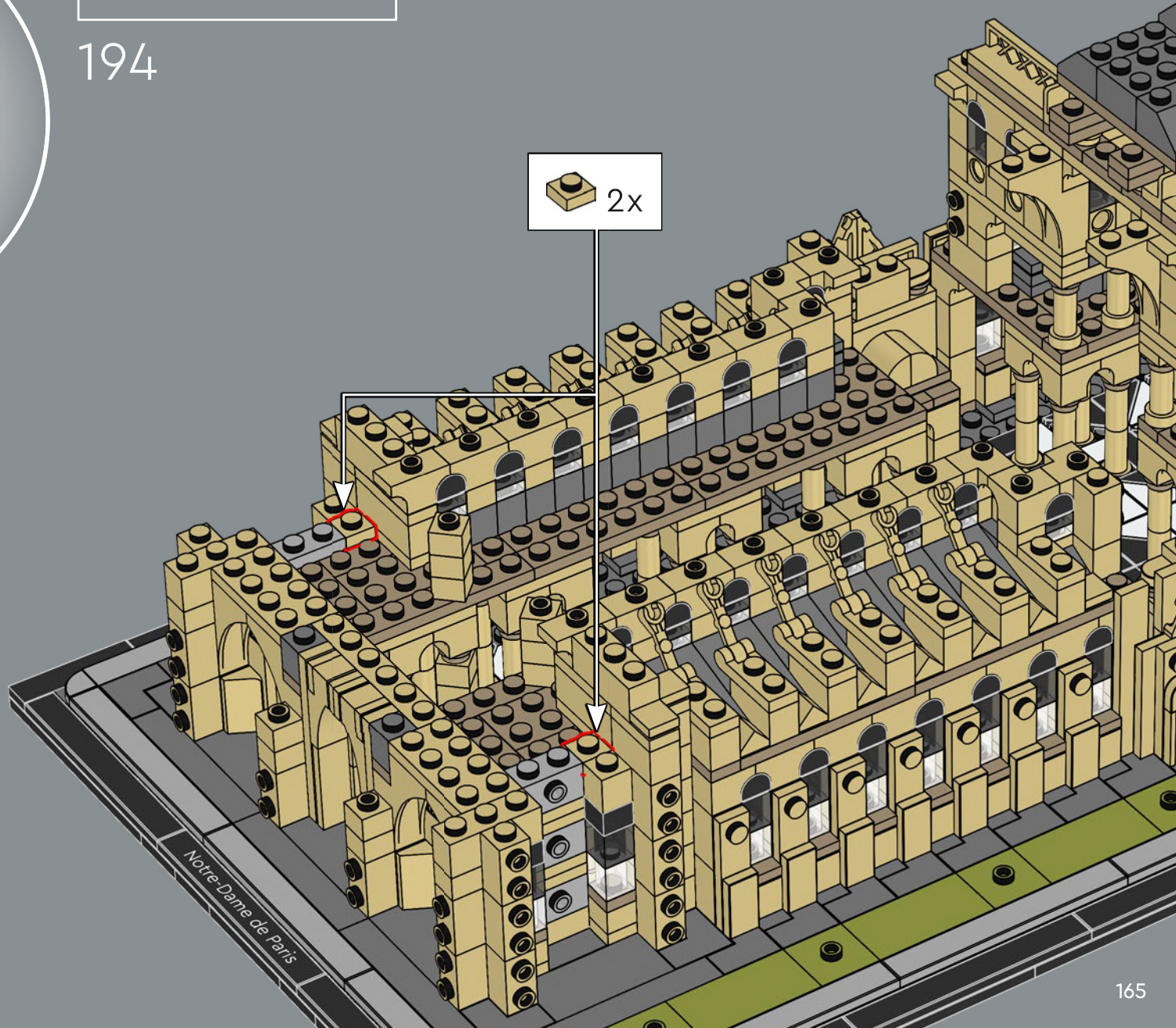

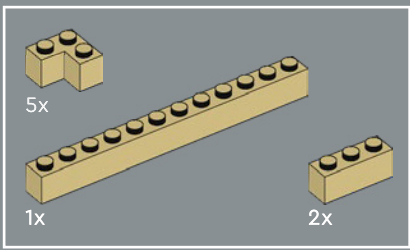

195

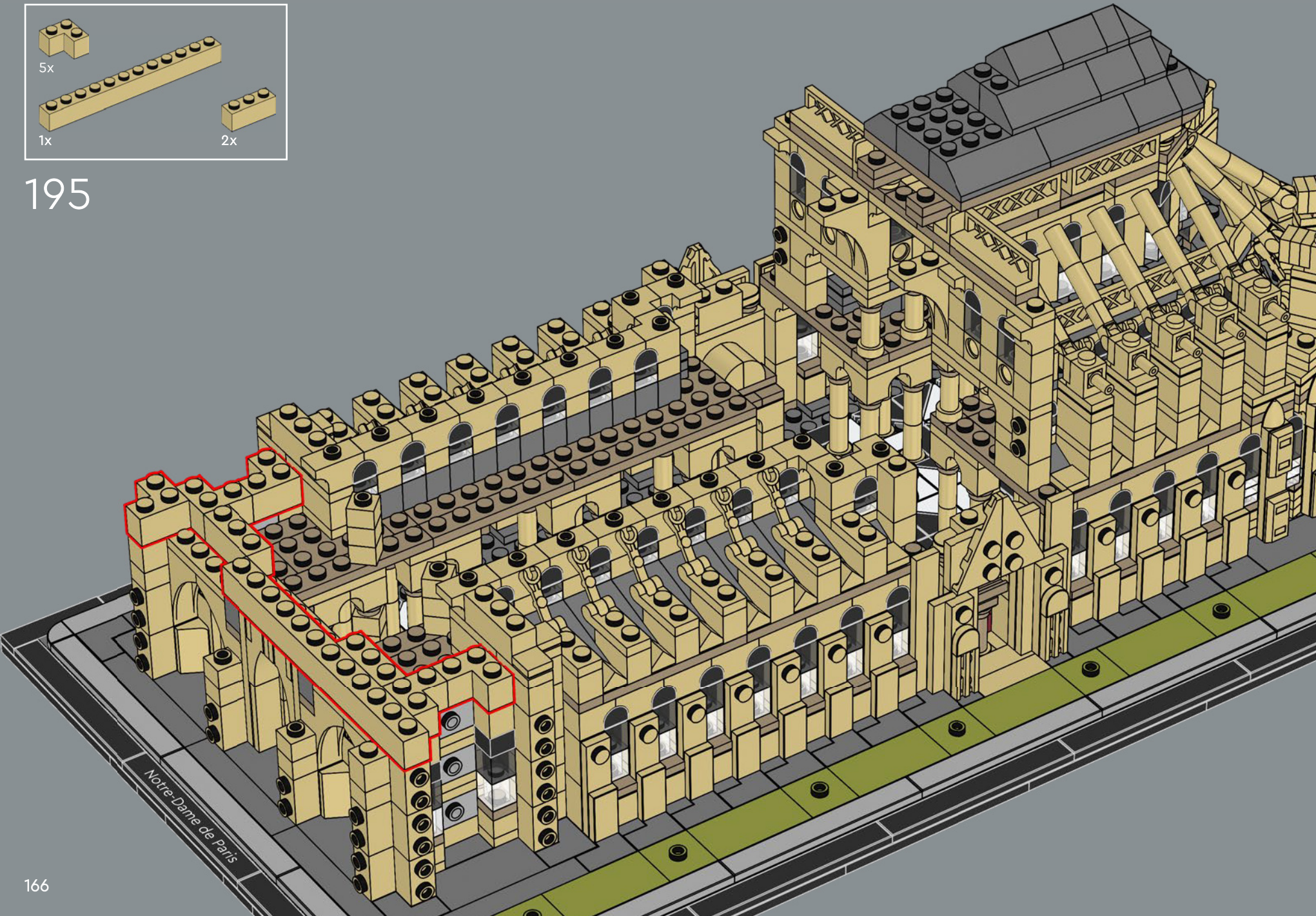

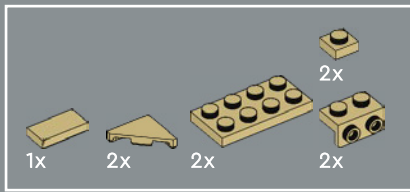

196

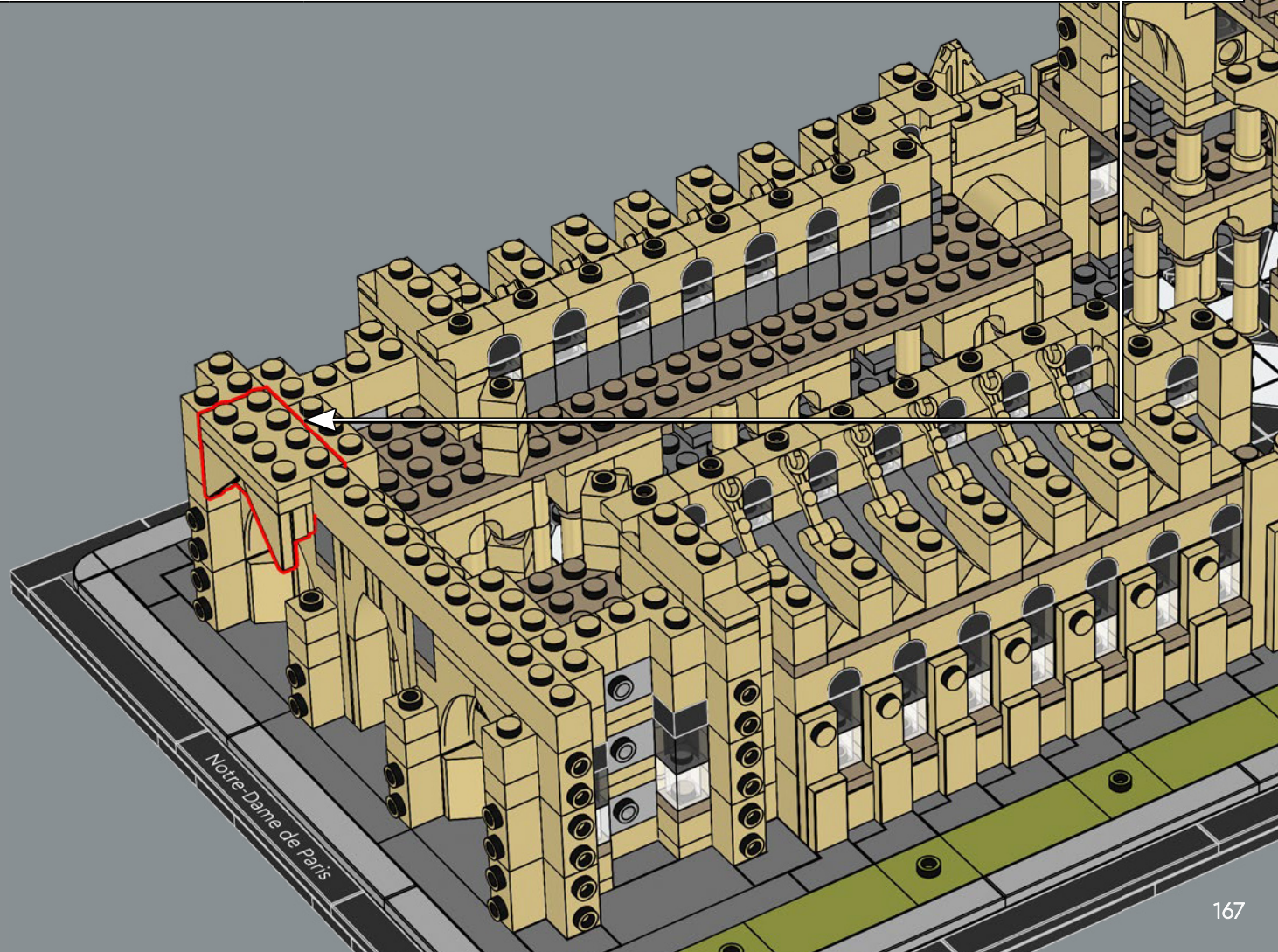
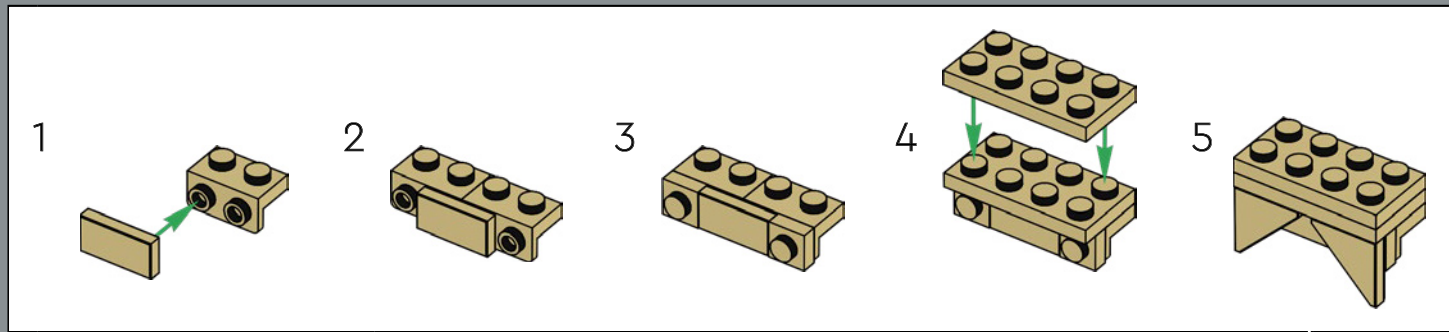

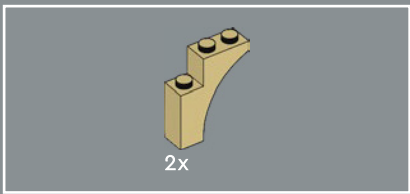

197

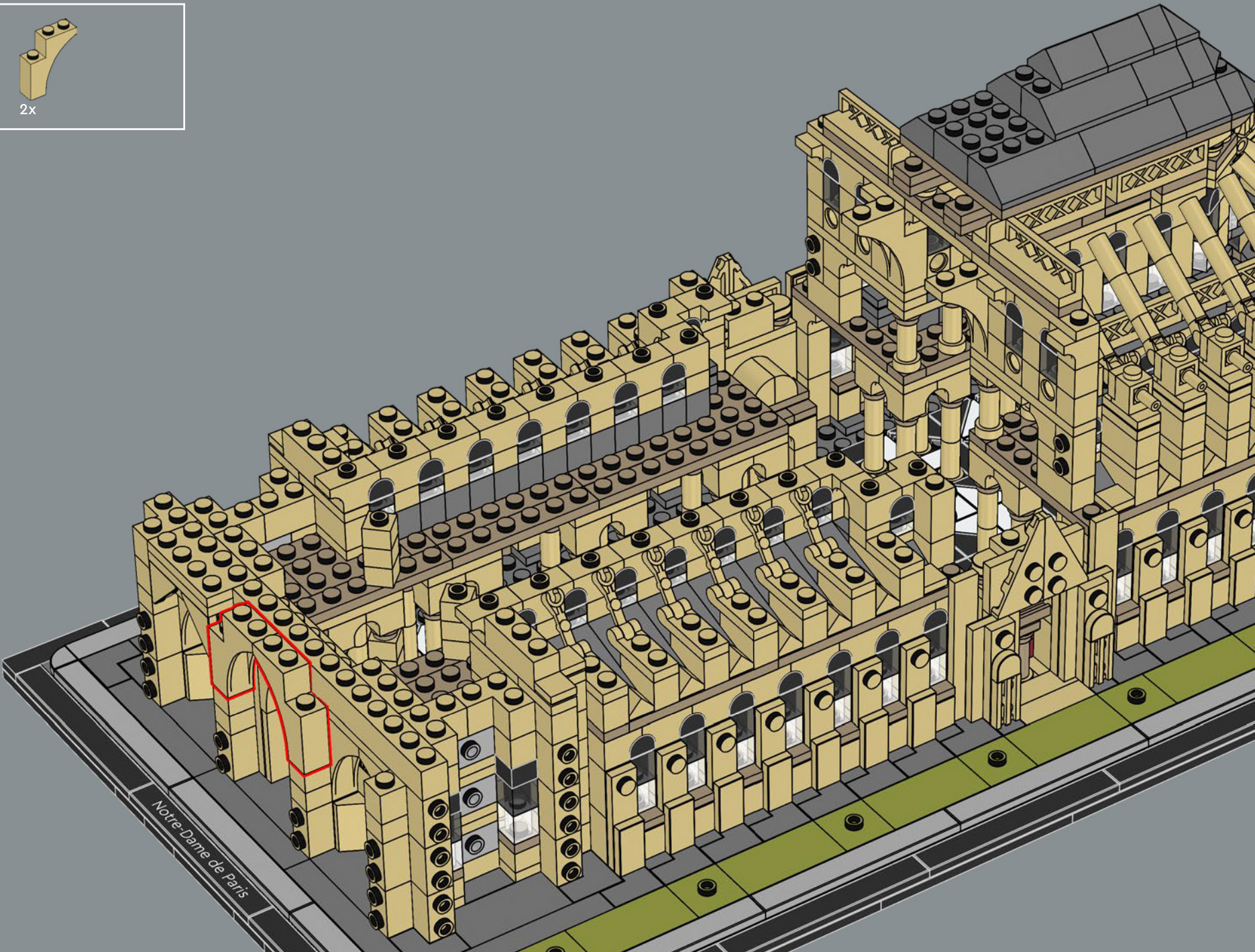

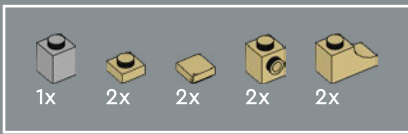

198

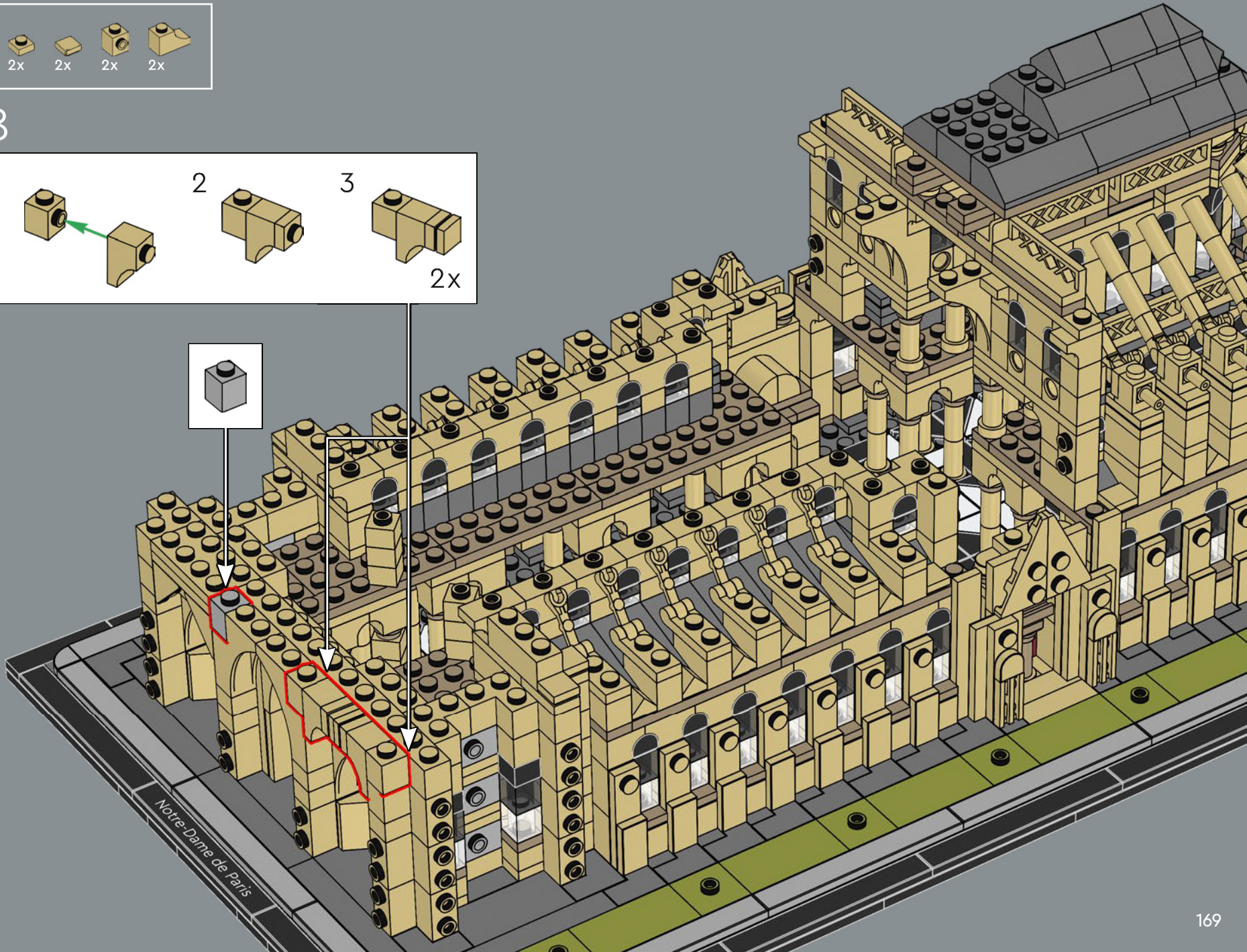
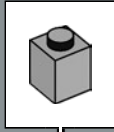
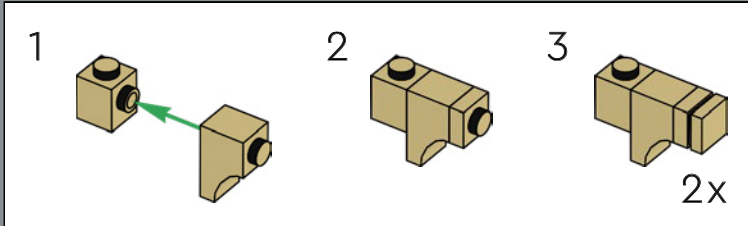

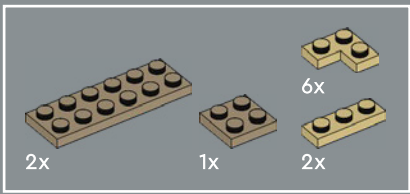

199



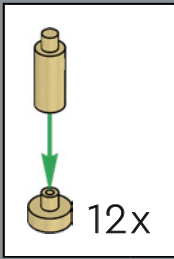

200

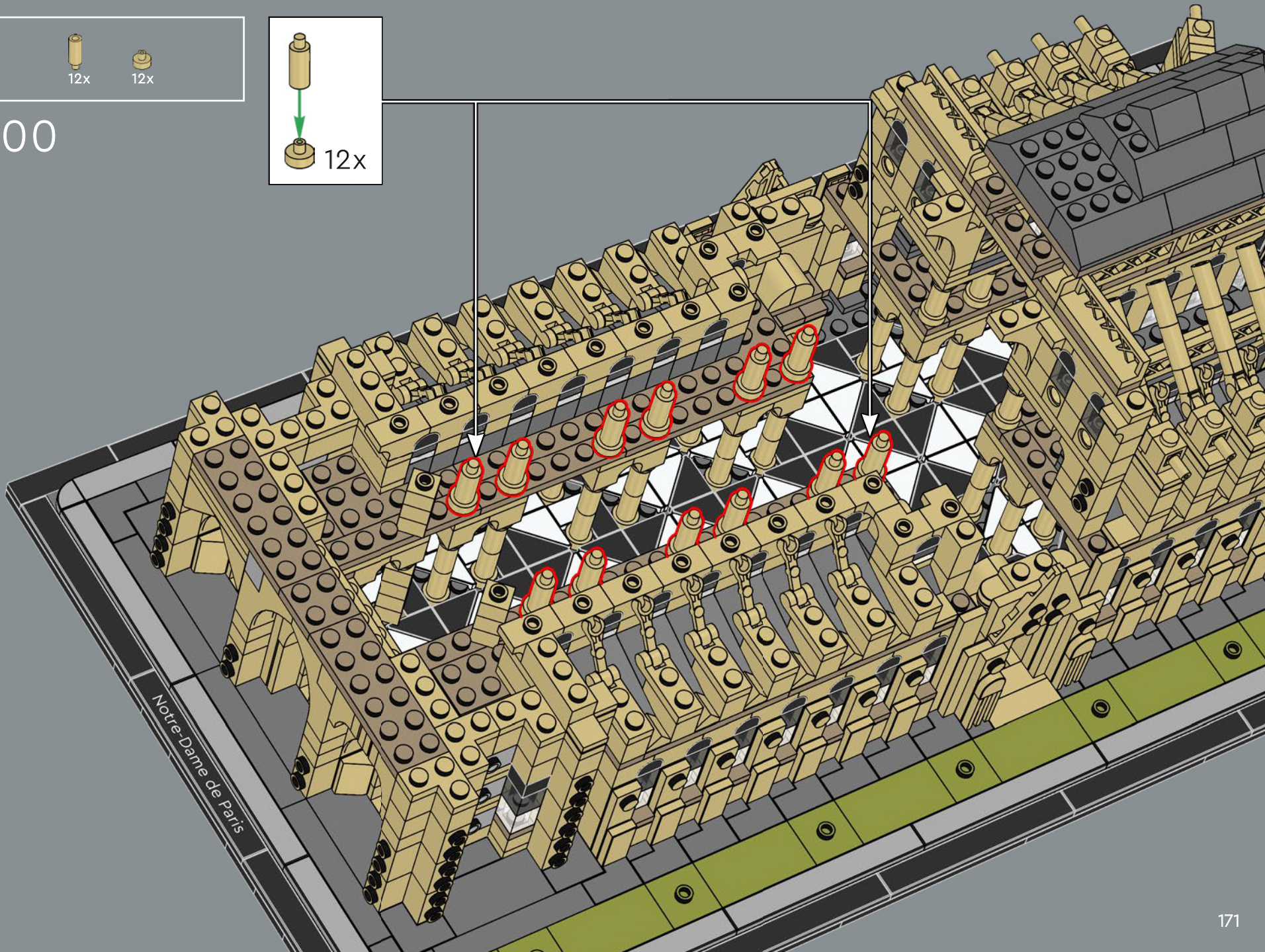

Notre-Dame de Paris

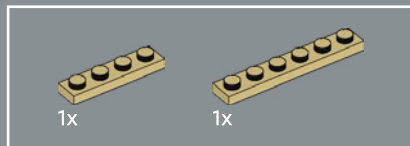
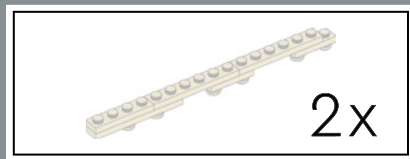

201

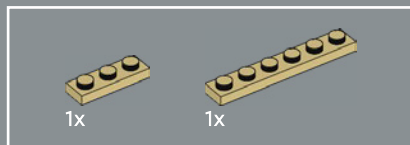
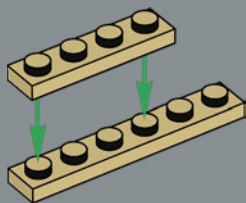

202

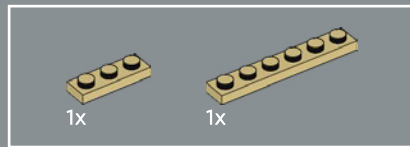
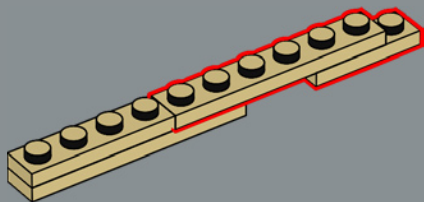

203

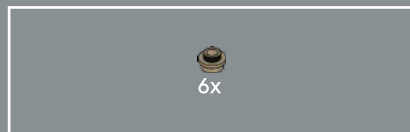
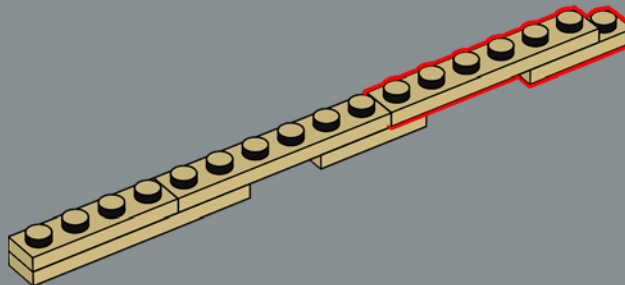

204

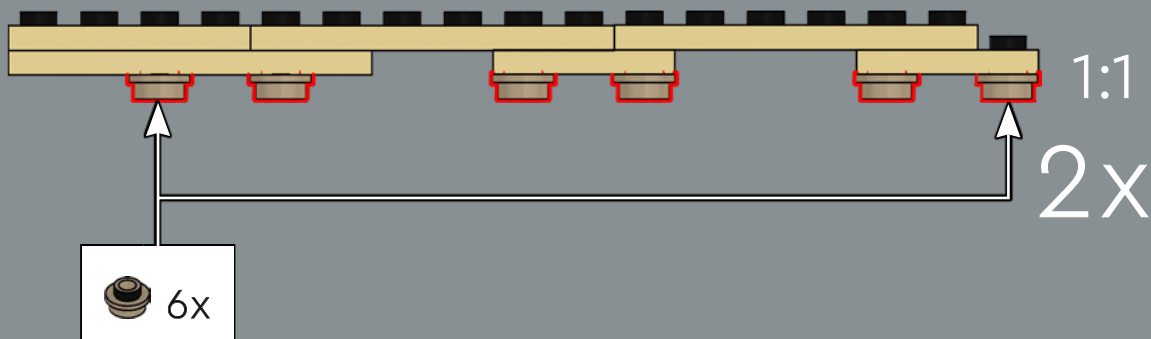

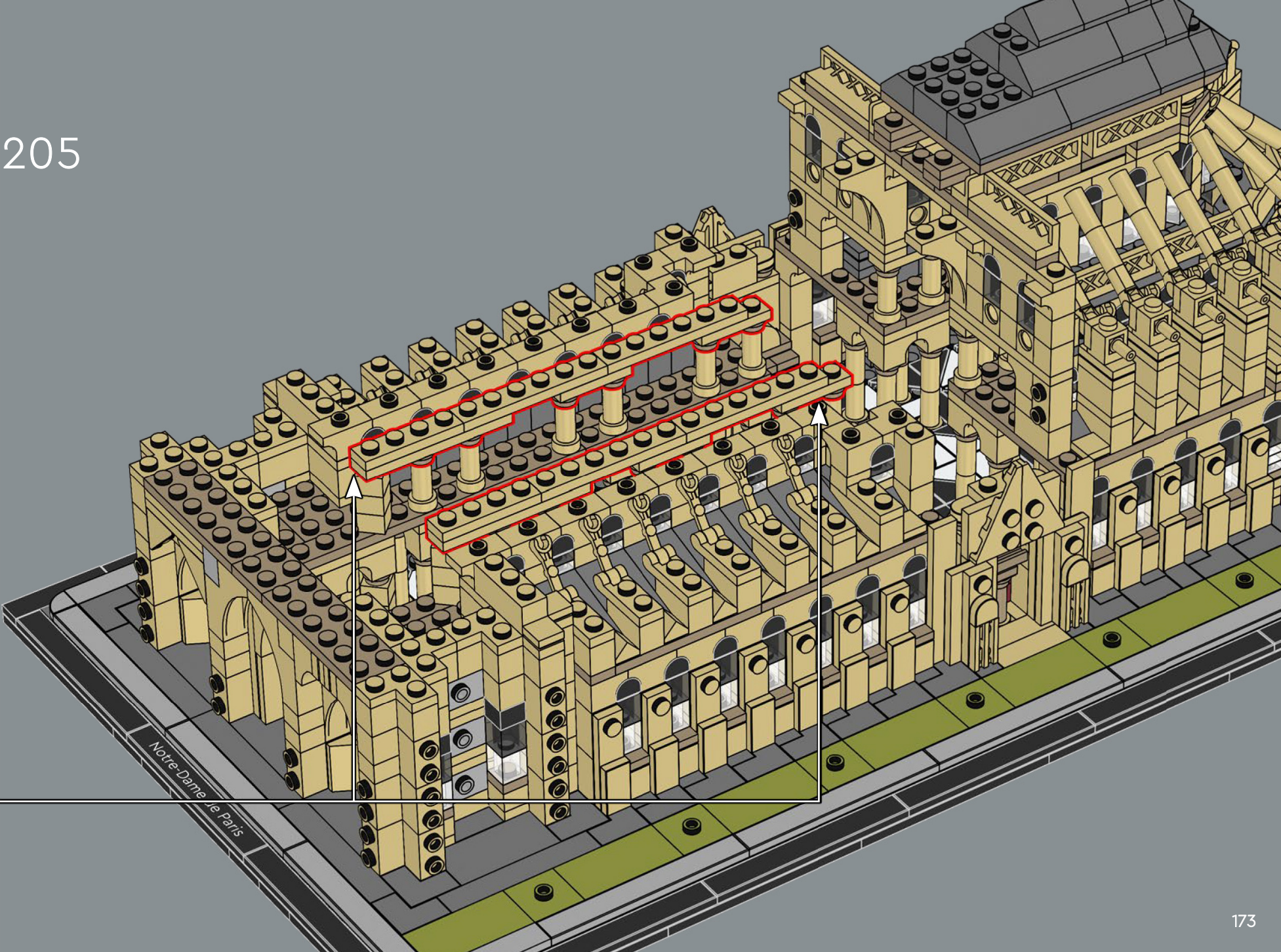

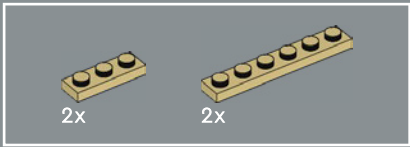

206

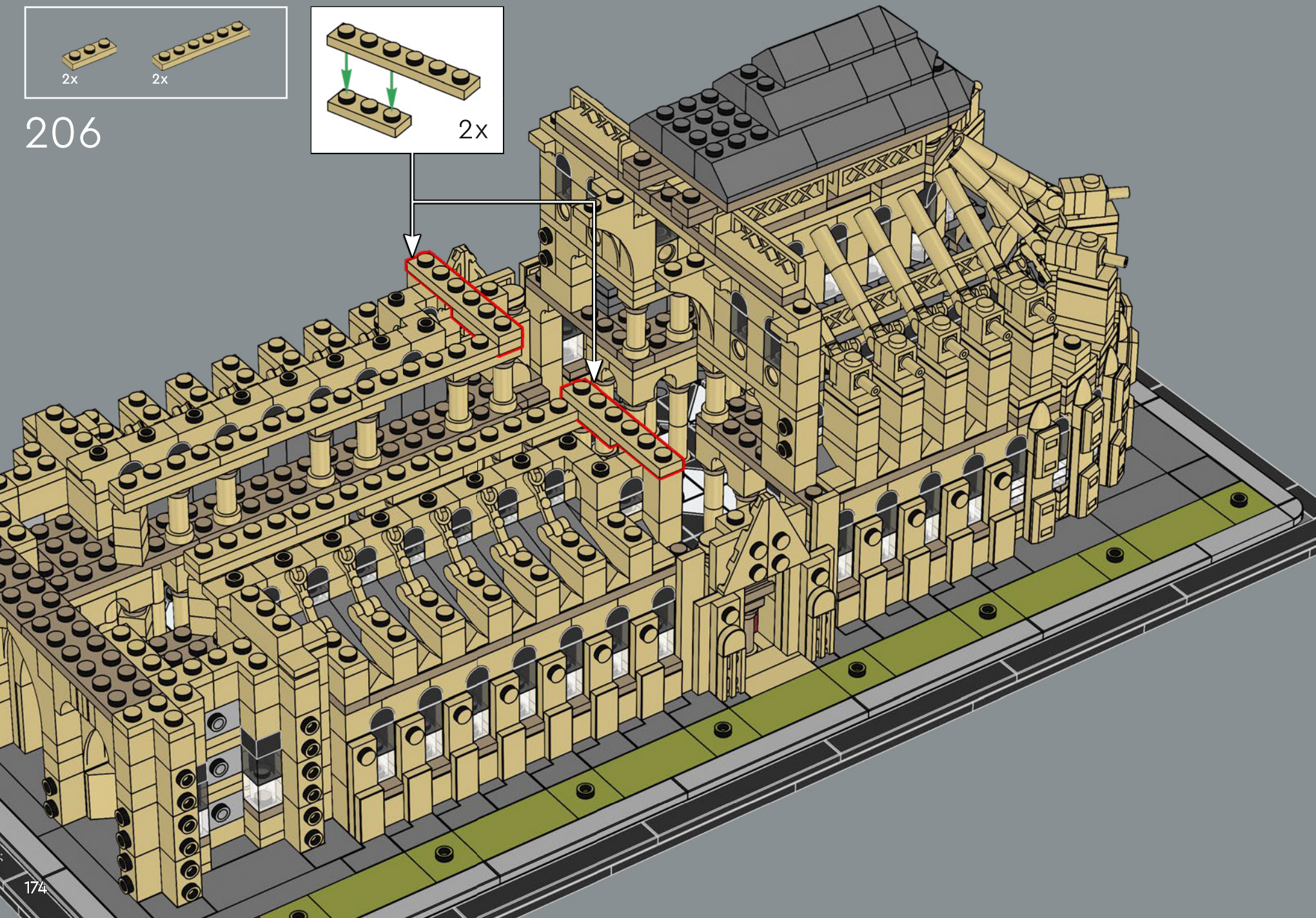
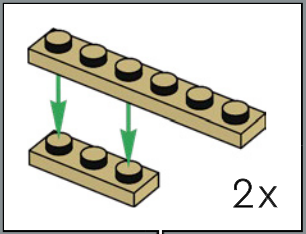

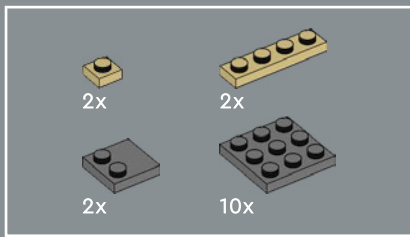

207





208

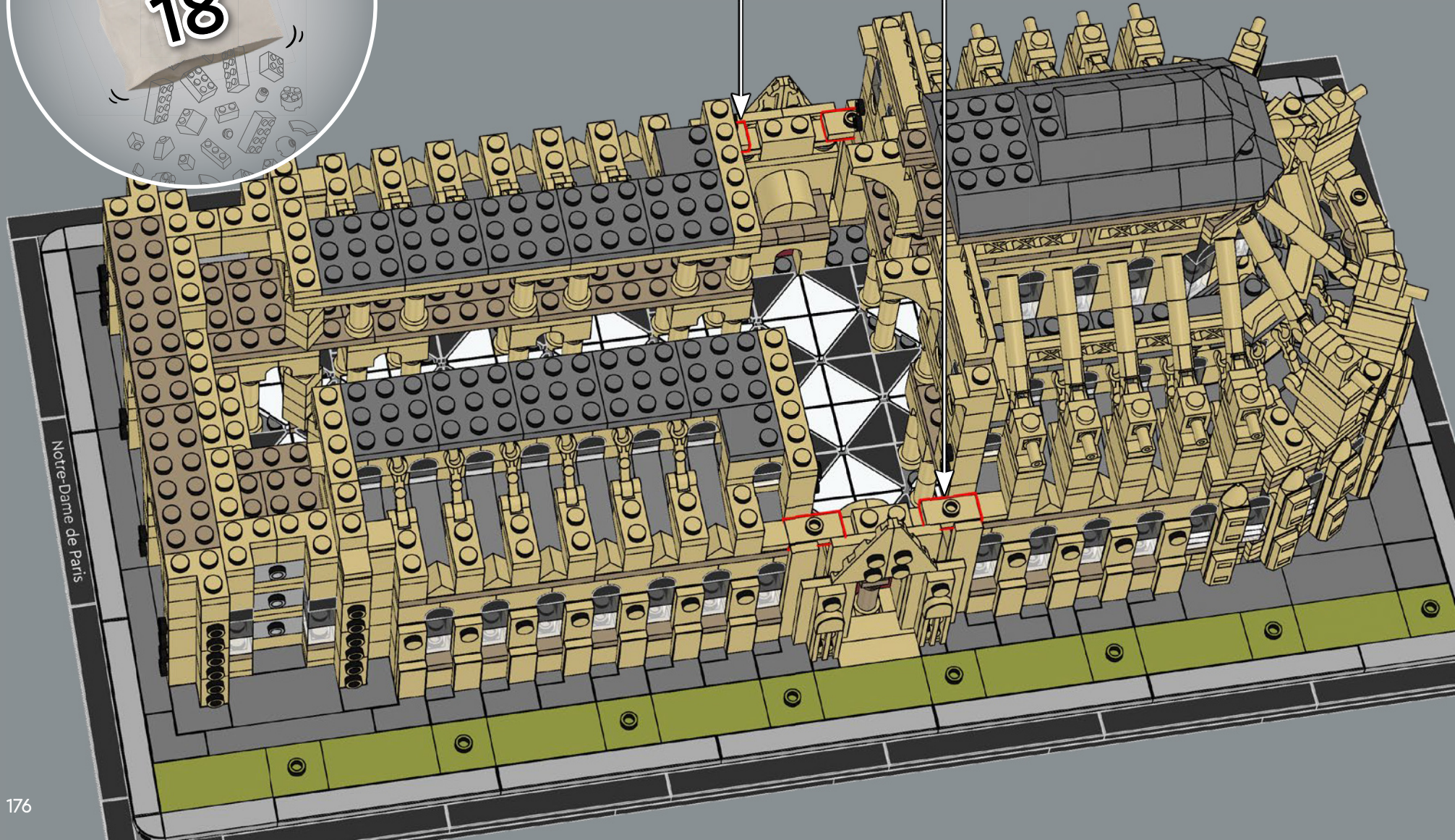
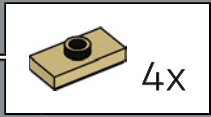

Notre-Dame de Paris

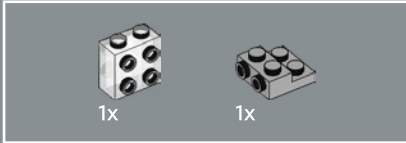
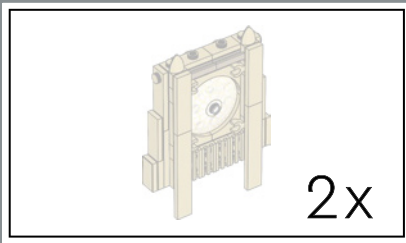

209

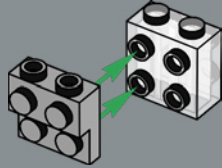

210

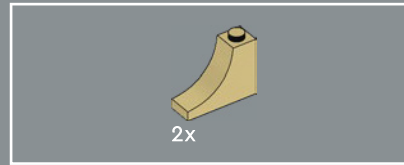
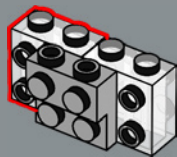

211

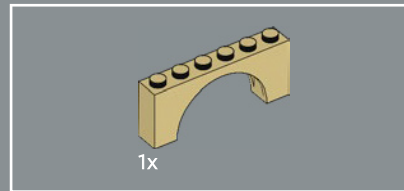
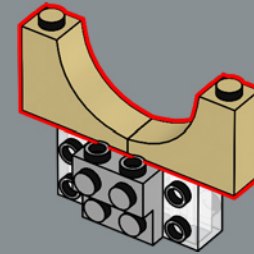

212

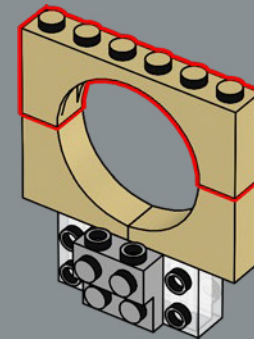

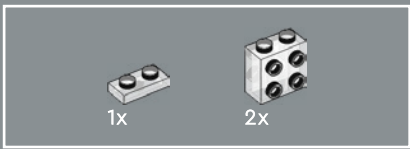

213

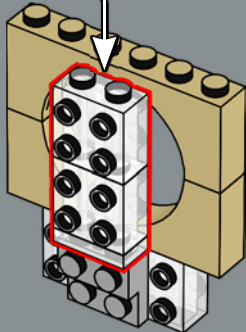
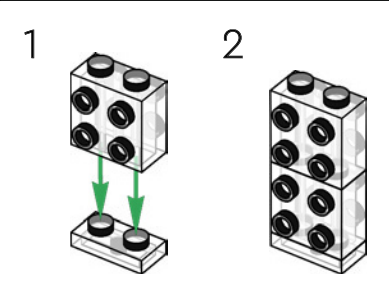

214

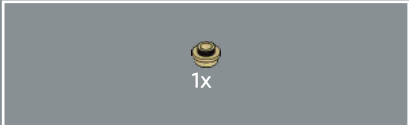
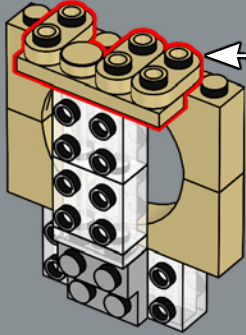
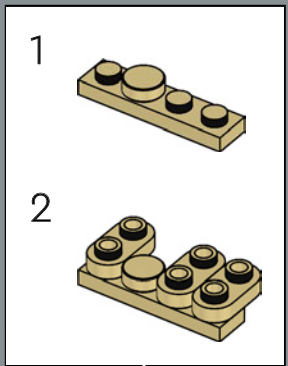

215

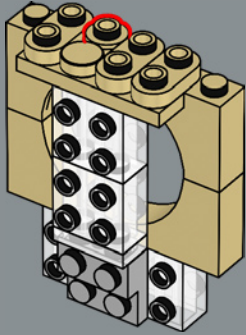

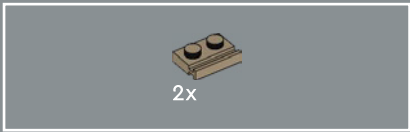

216

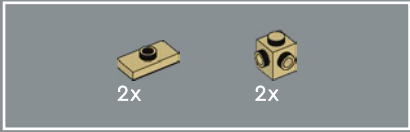
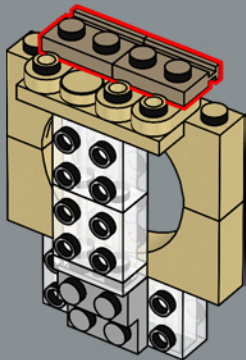

217

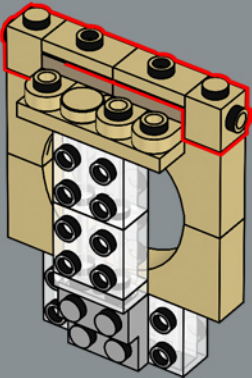

218

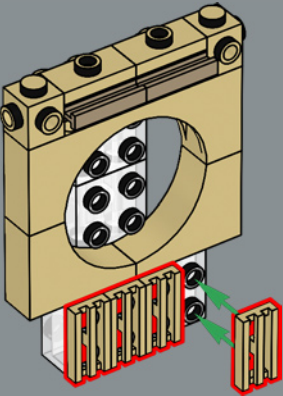

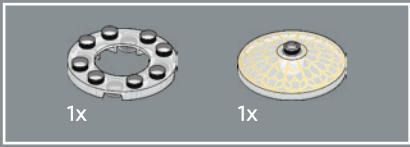

219

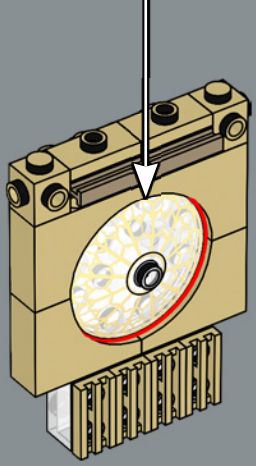
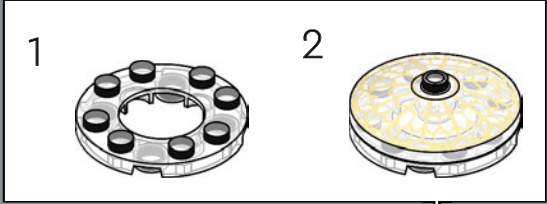

220

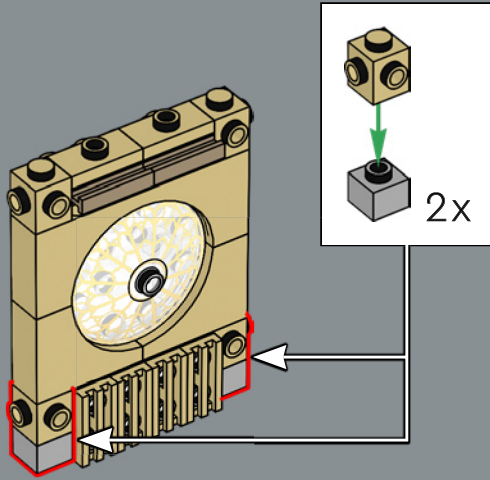

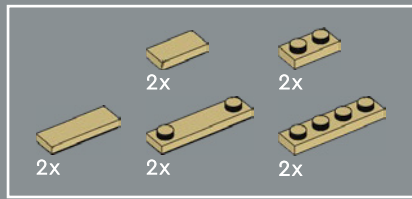

221

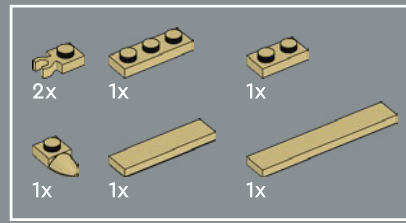
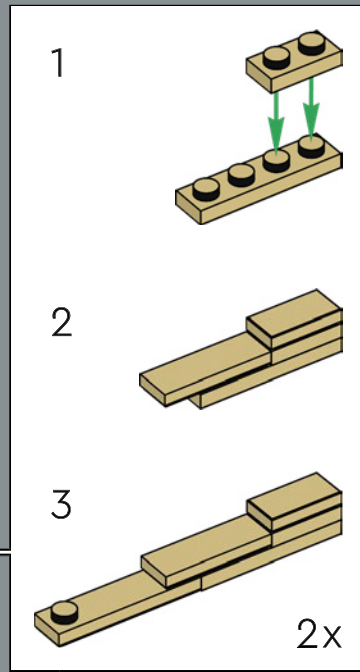
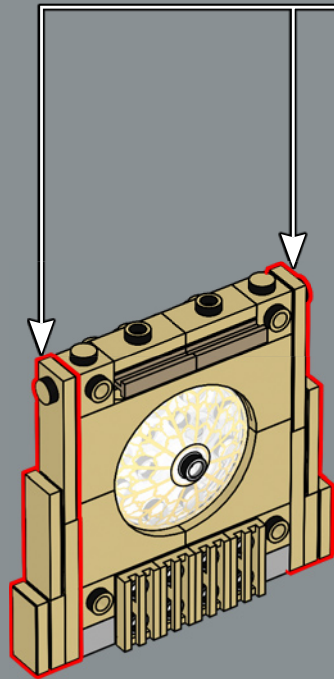

222

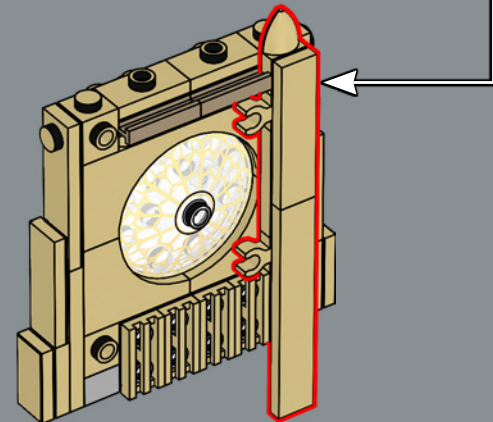
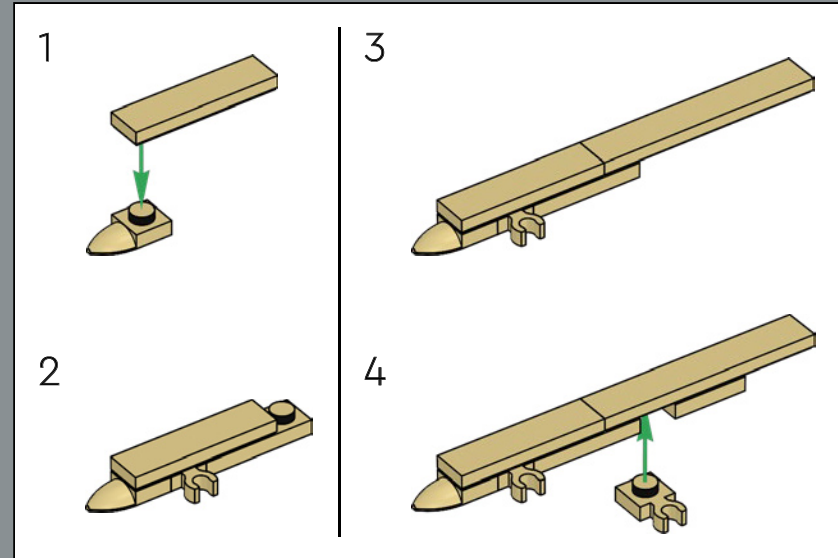

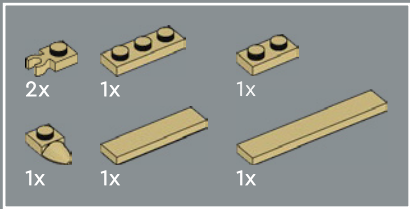

223

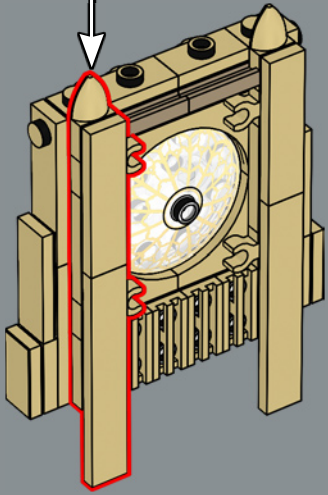
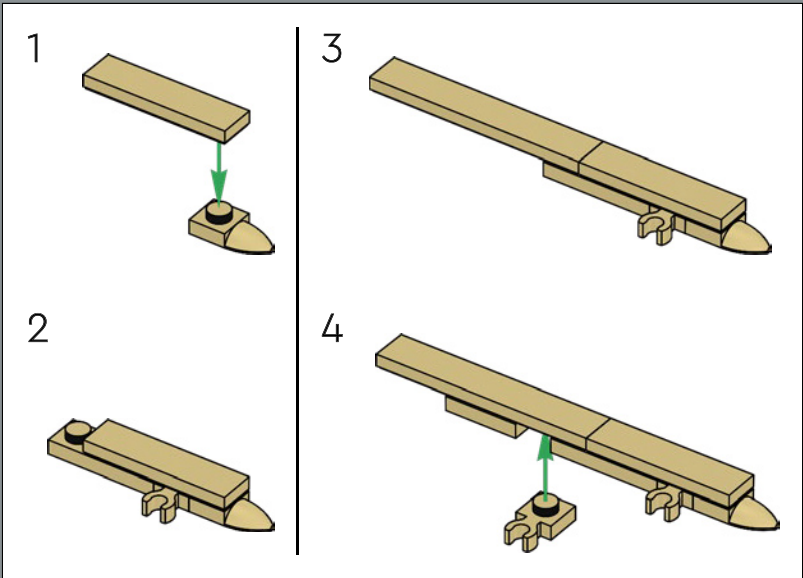

2x

224

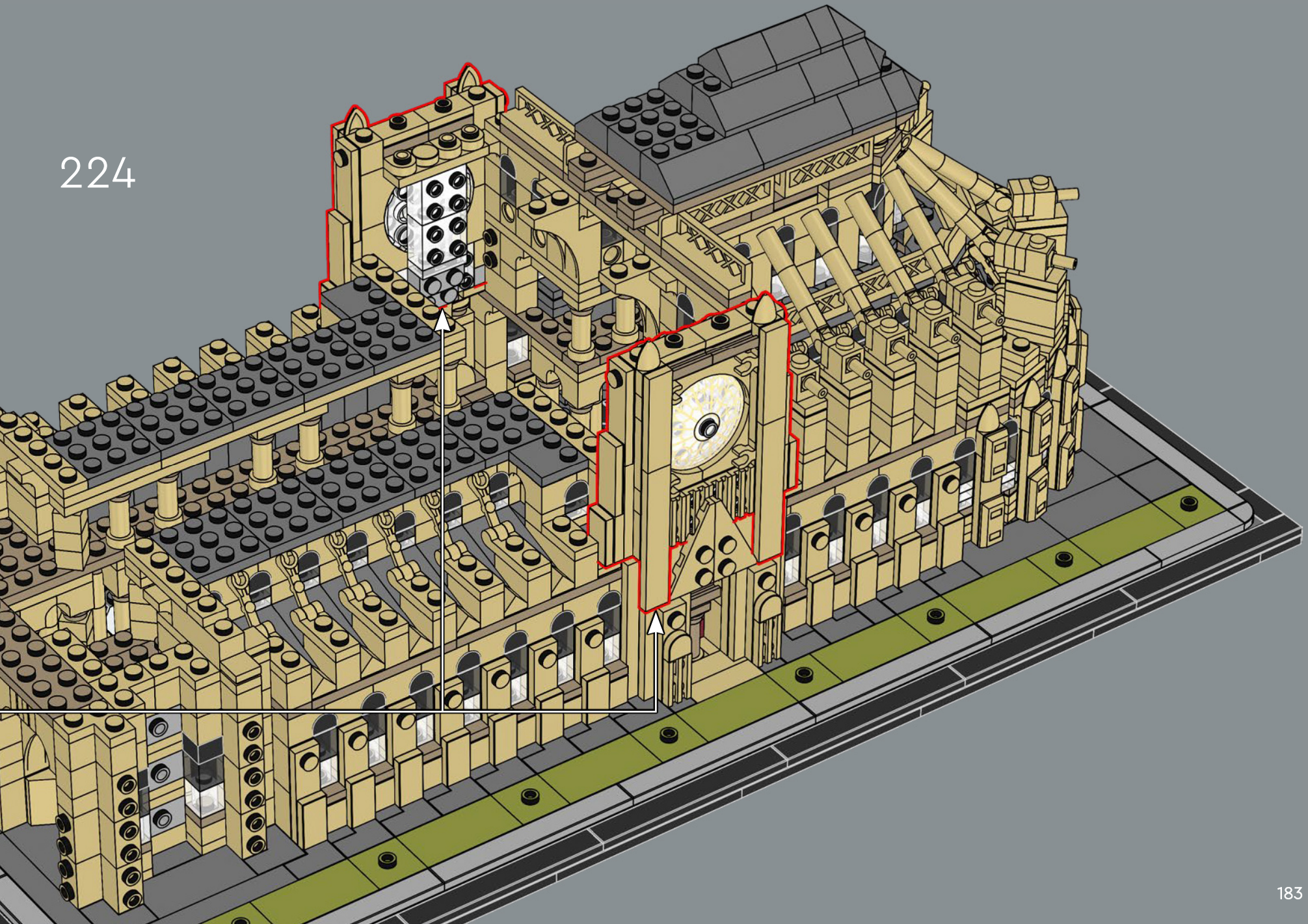

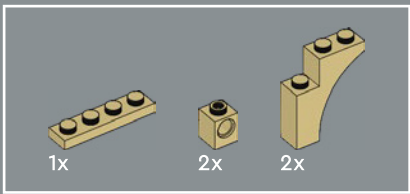

225

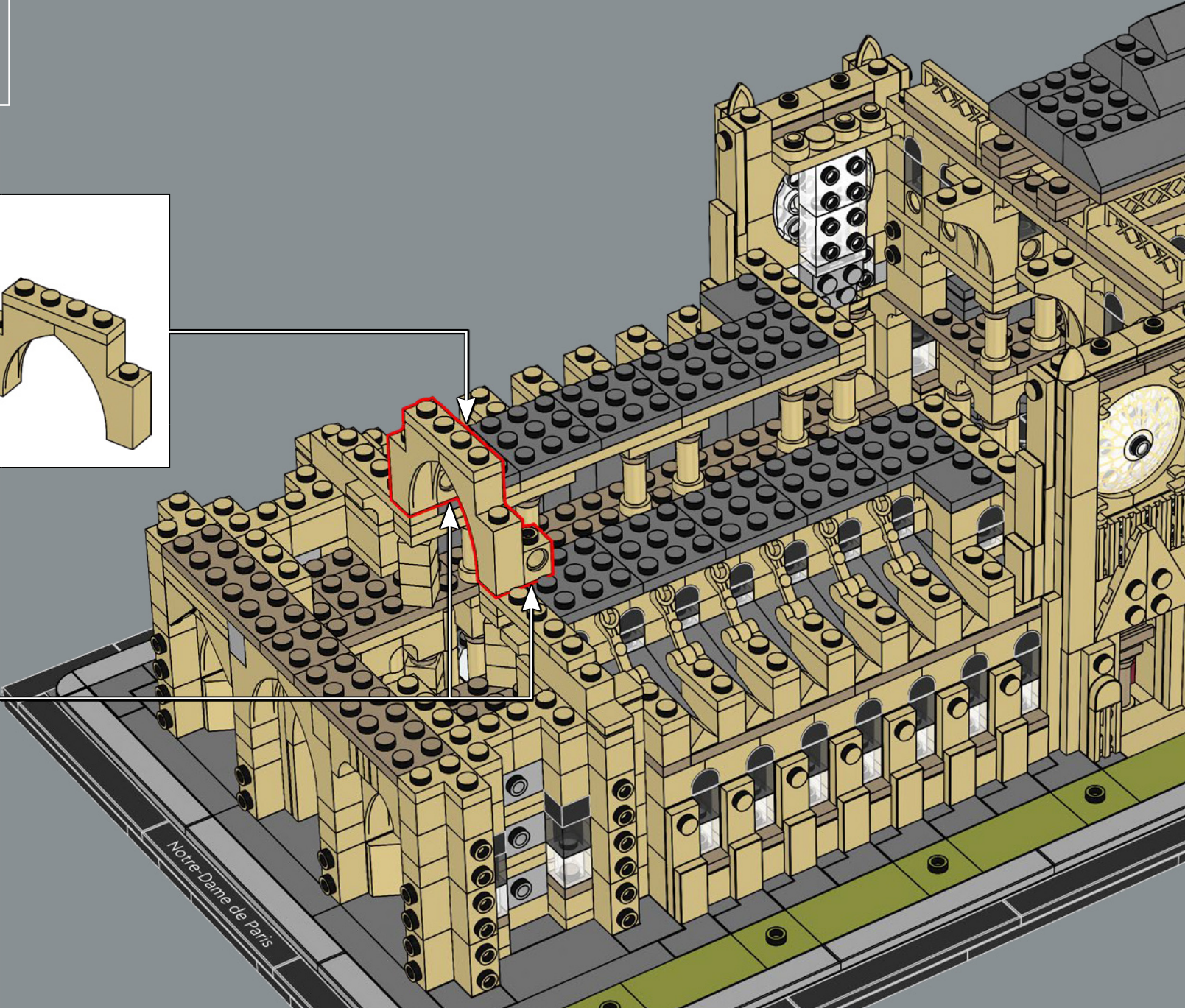
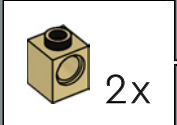
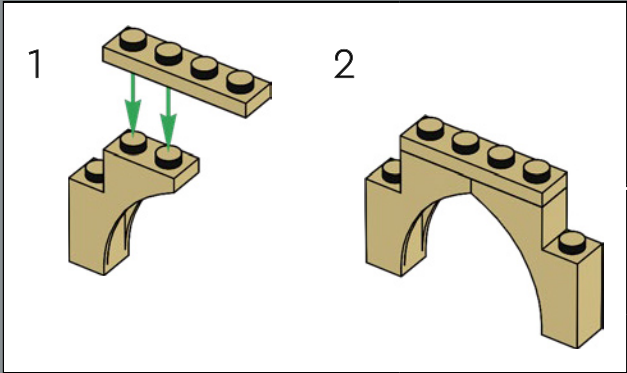

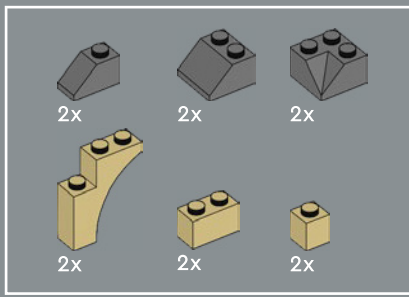

226

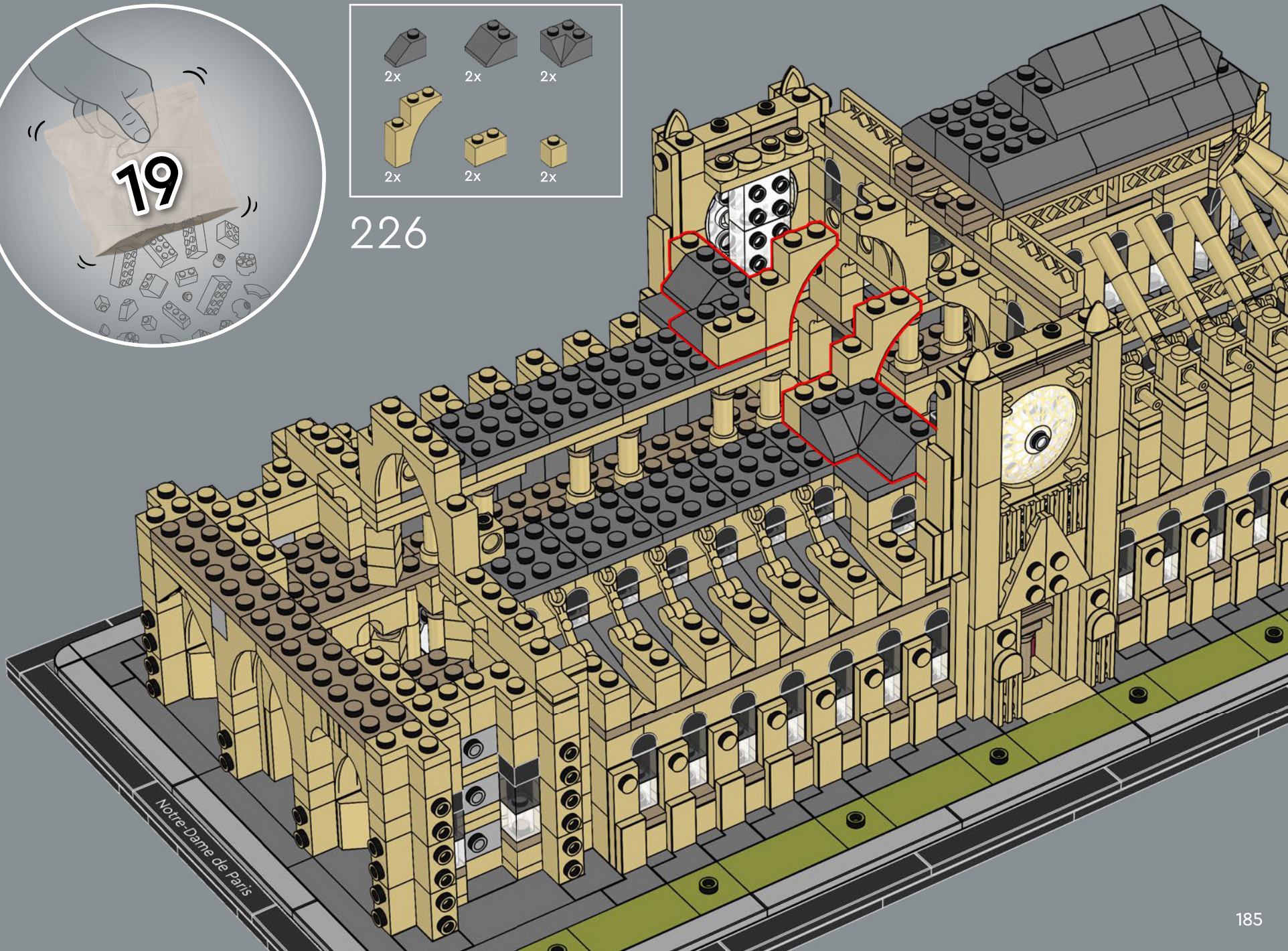

Notre-Dame de Paris



8x

227

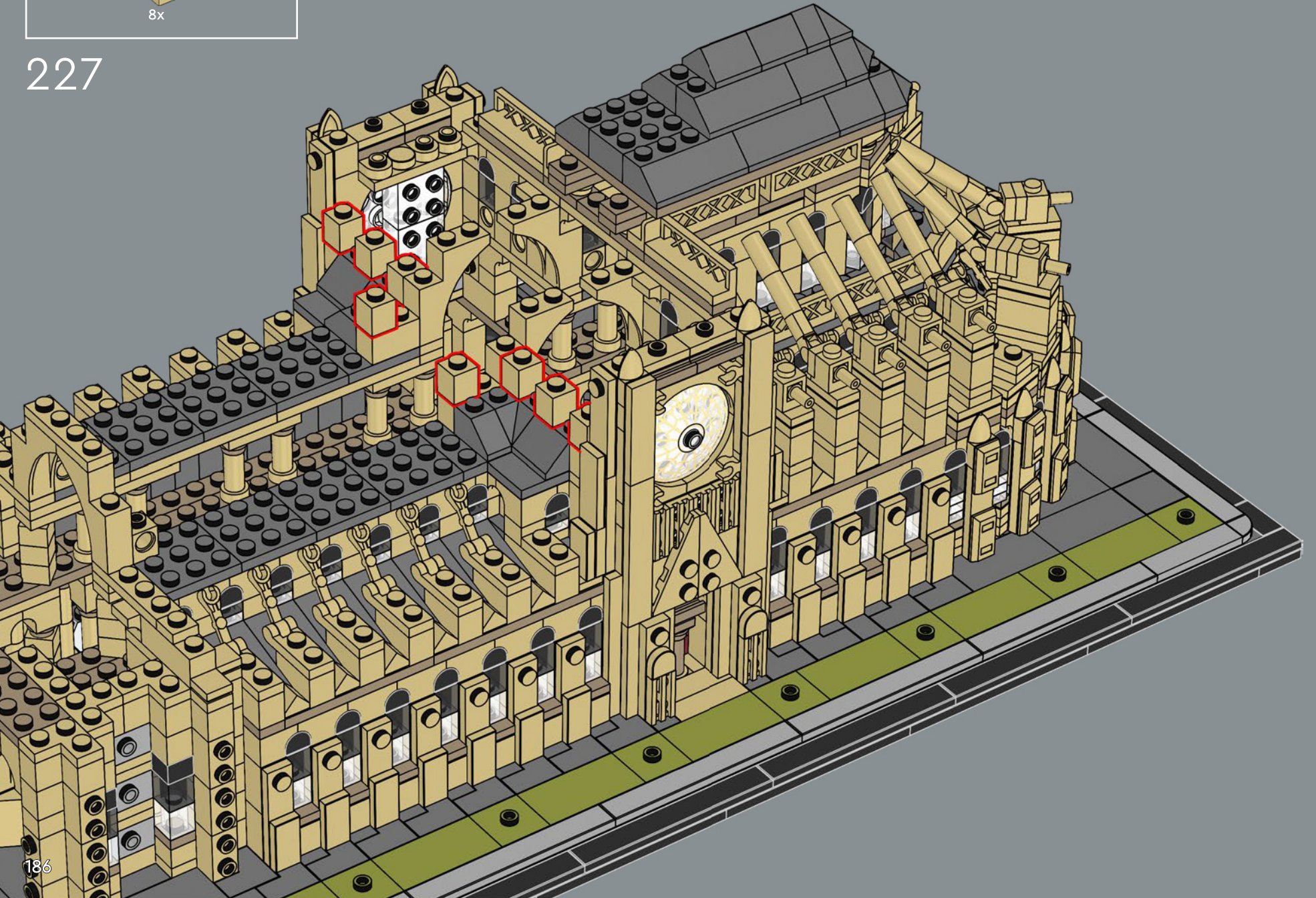

Las bóvedas se dividen en seis partes mediante nervios para formar una bóveda sexpartita. El modelo LEGO® recrea la edificación original incorporando una nervadura transversal cada dos capiteles.

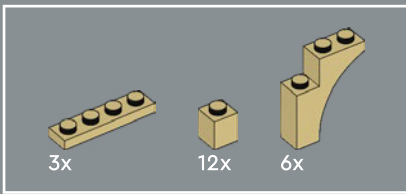

228

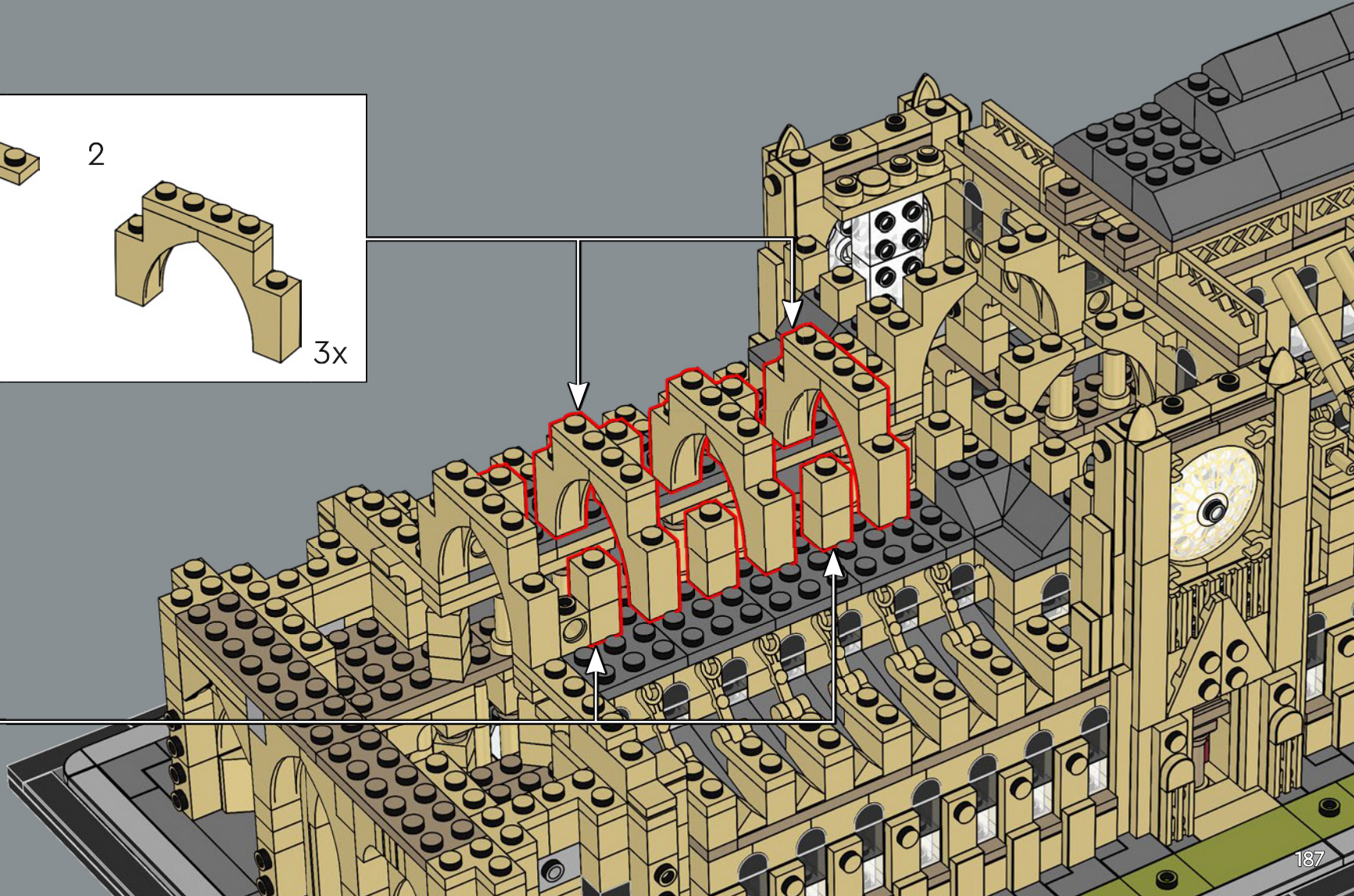
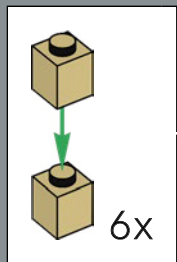
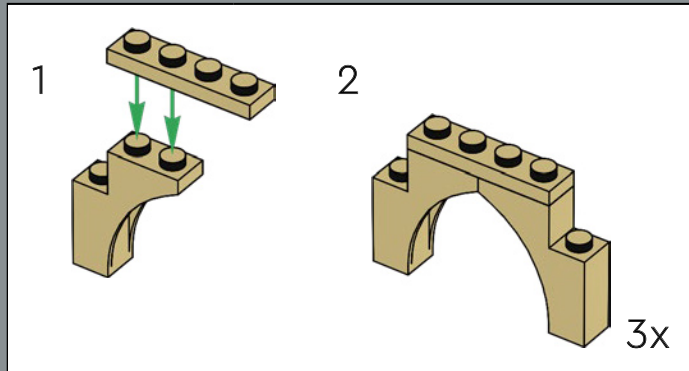



12x



20x



20x

229



8x



12x

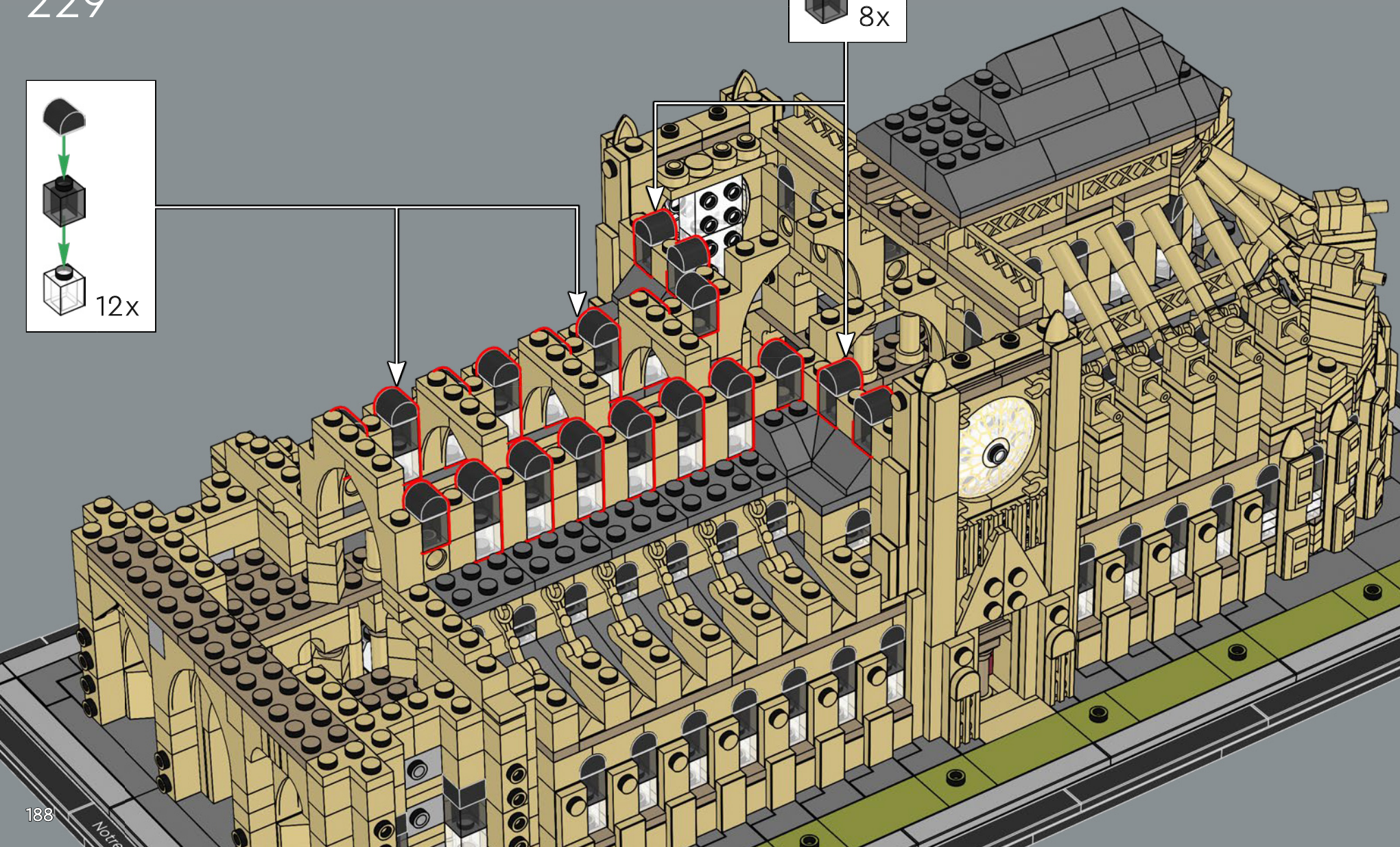

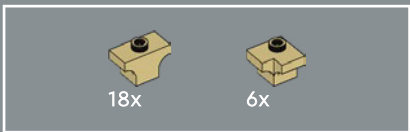

230

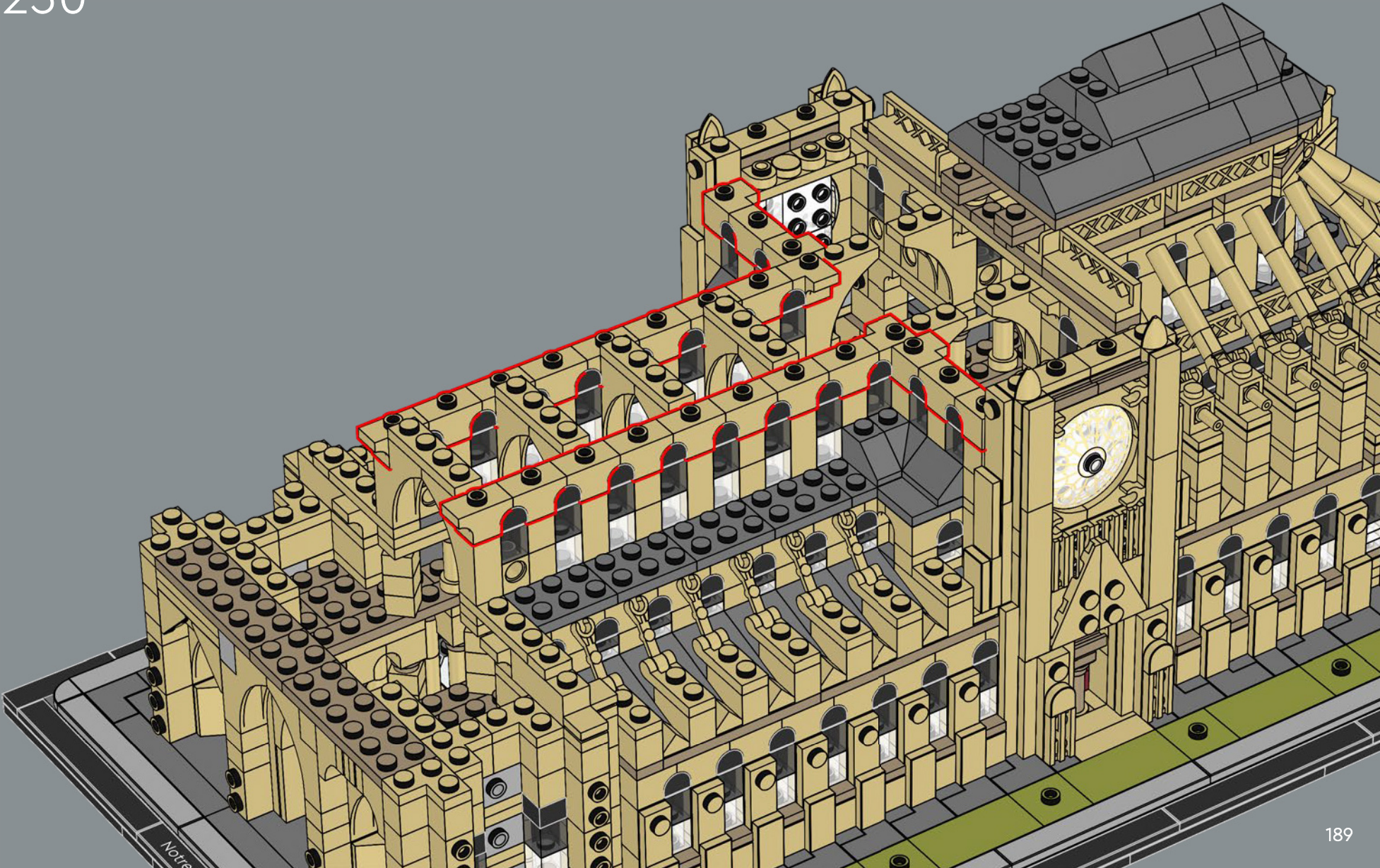

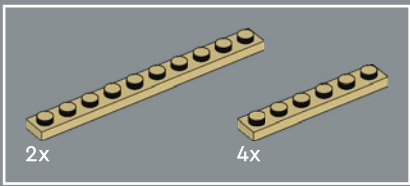

231

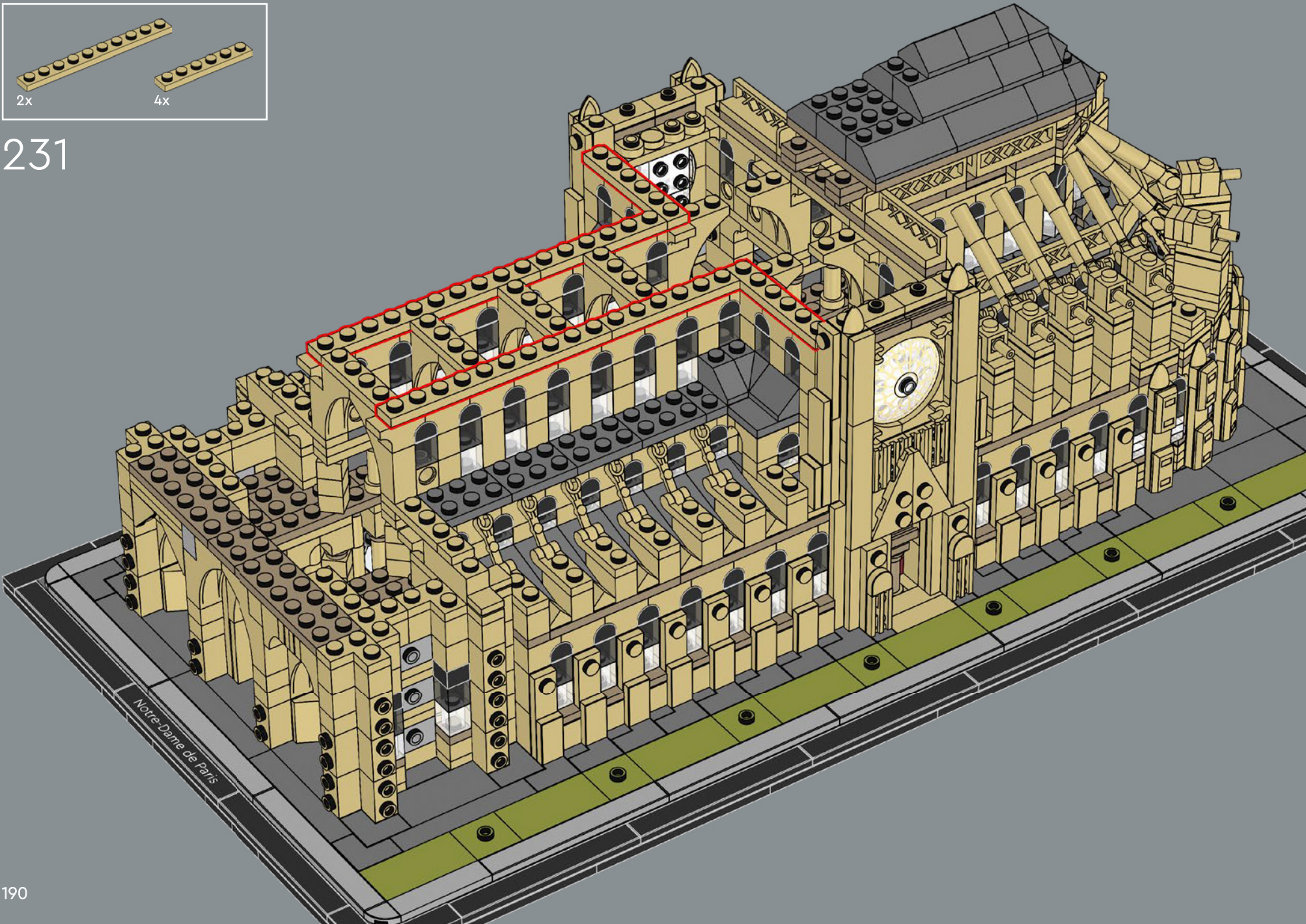

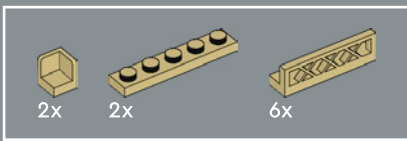

232

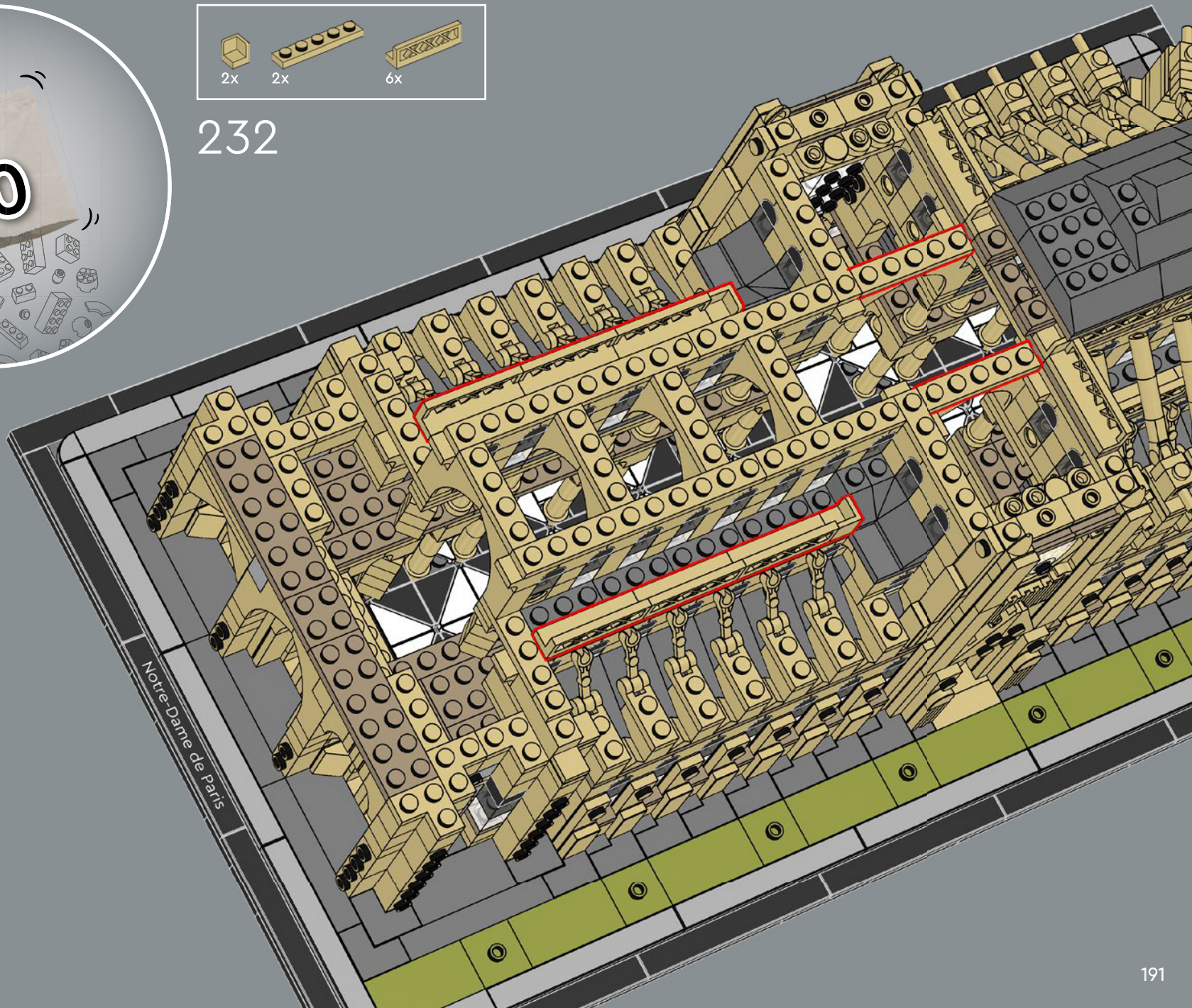

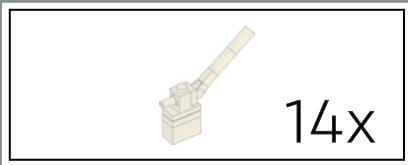

Los arbotantes del modelo LEGO® incluyen elementos concebidos como velas cuyos orificios reproducen los canales de los arbotantes reales.

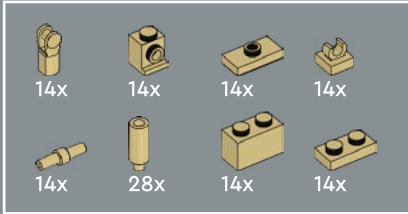

233

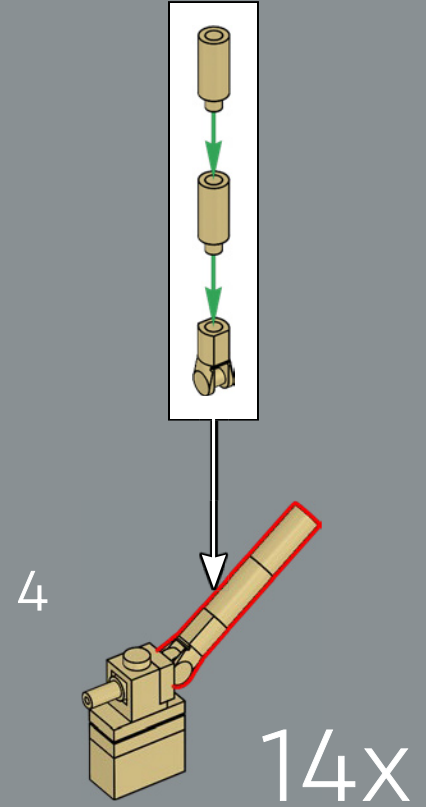
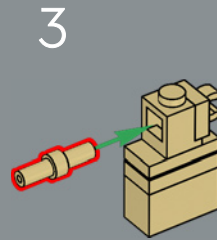
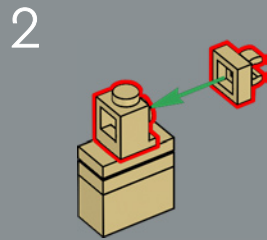
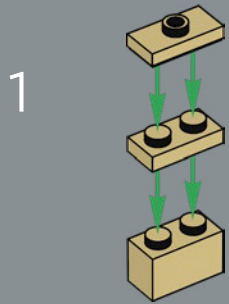

En 1225 se instalan en los voladizos de la nave principal los canales que drenan el agua de lluvia del tejado a través de las gárgolas.

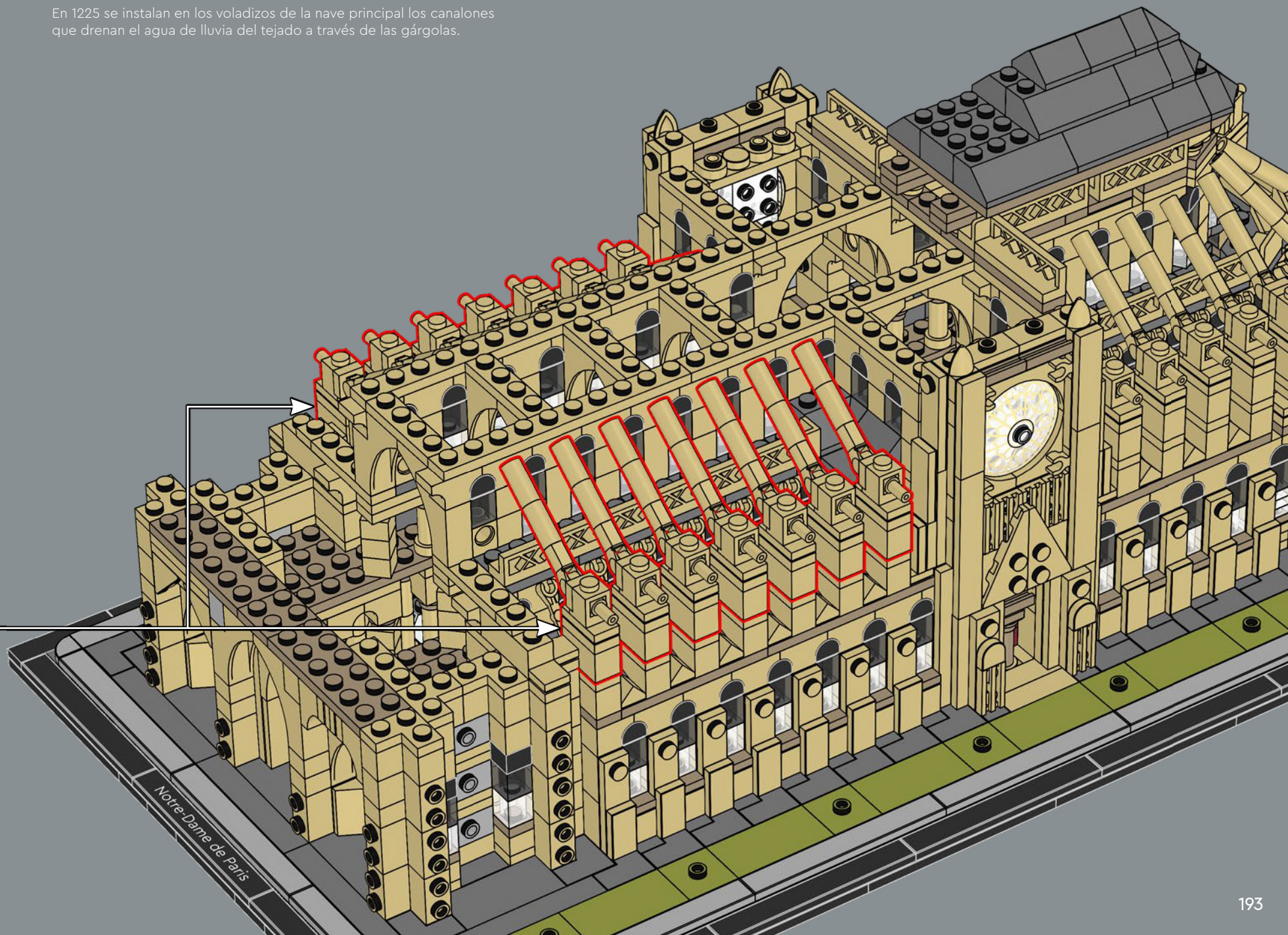

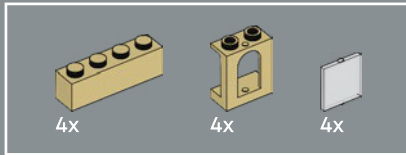
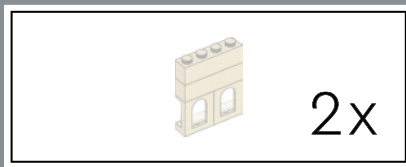

234

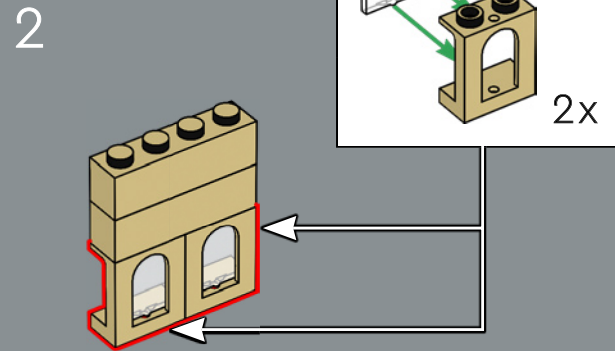
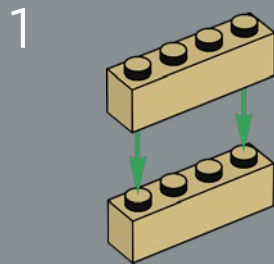

2x

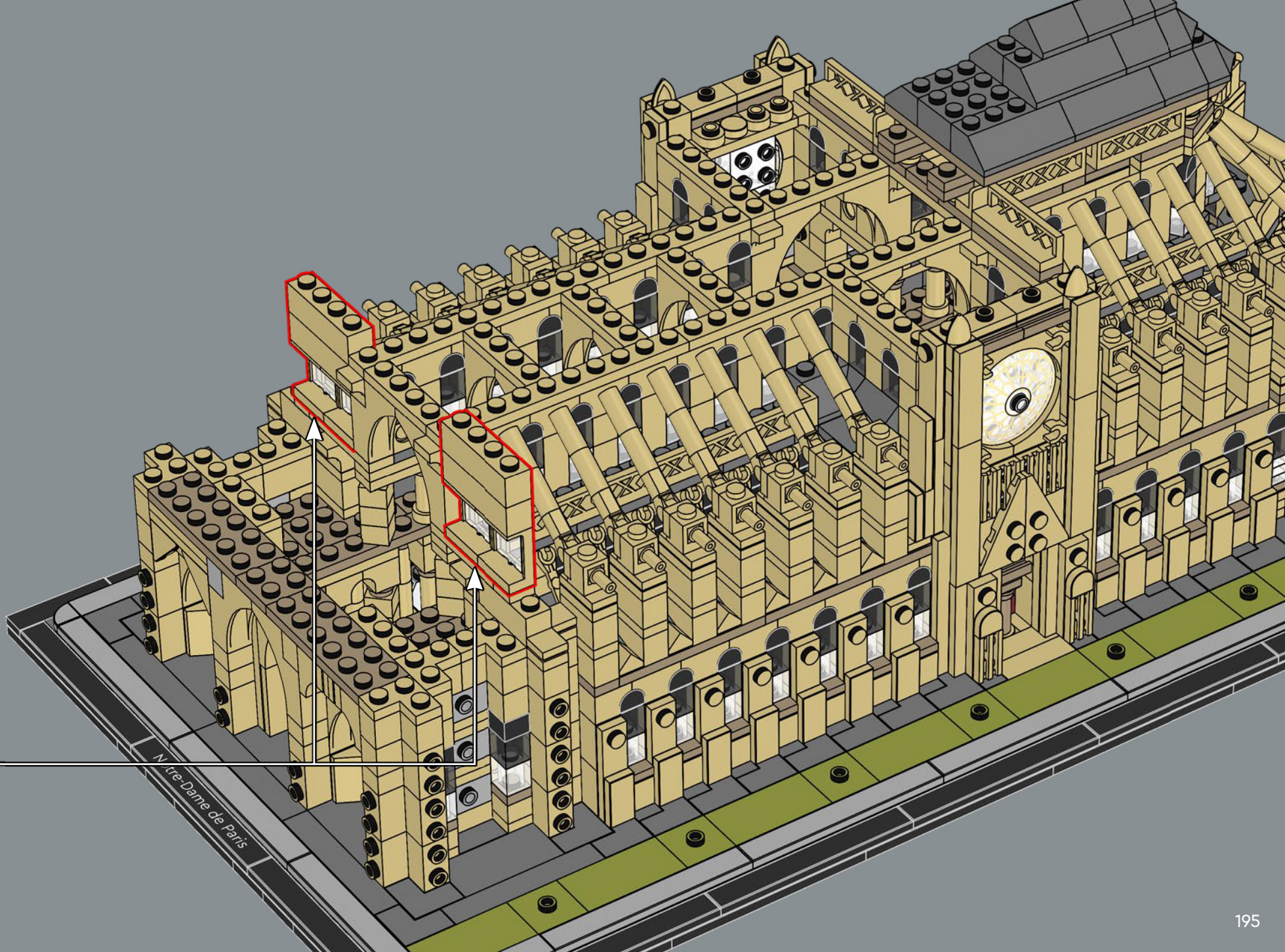

Notre-Dame de Paris

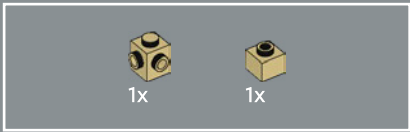

235

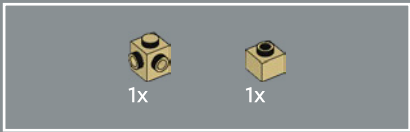
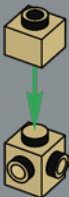

236



237

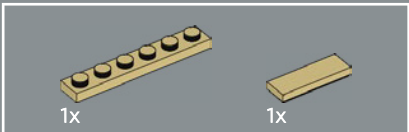

238

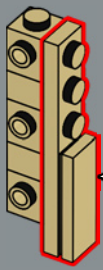
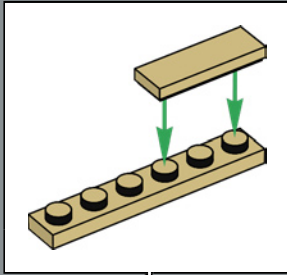

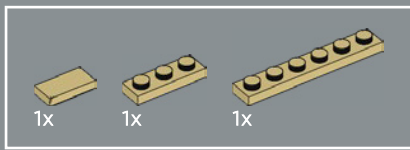

239

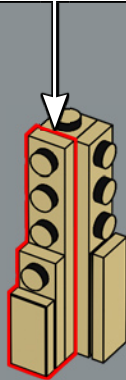
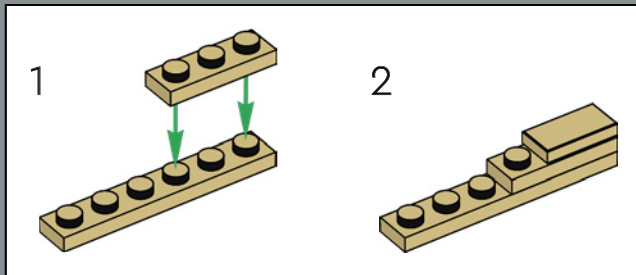

240

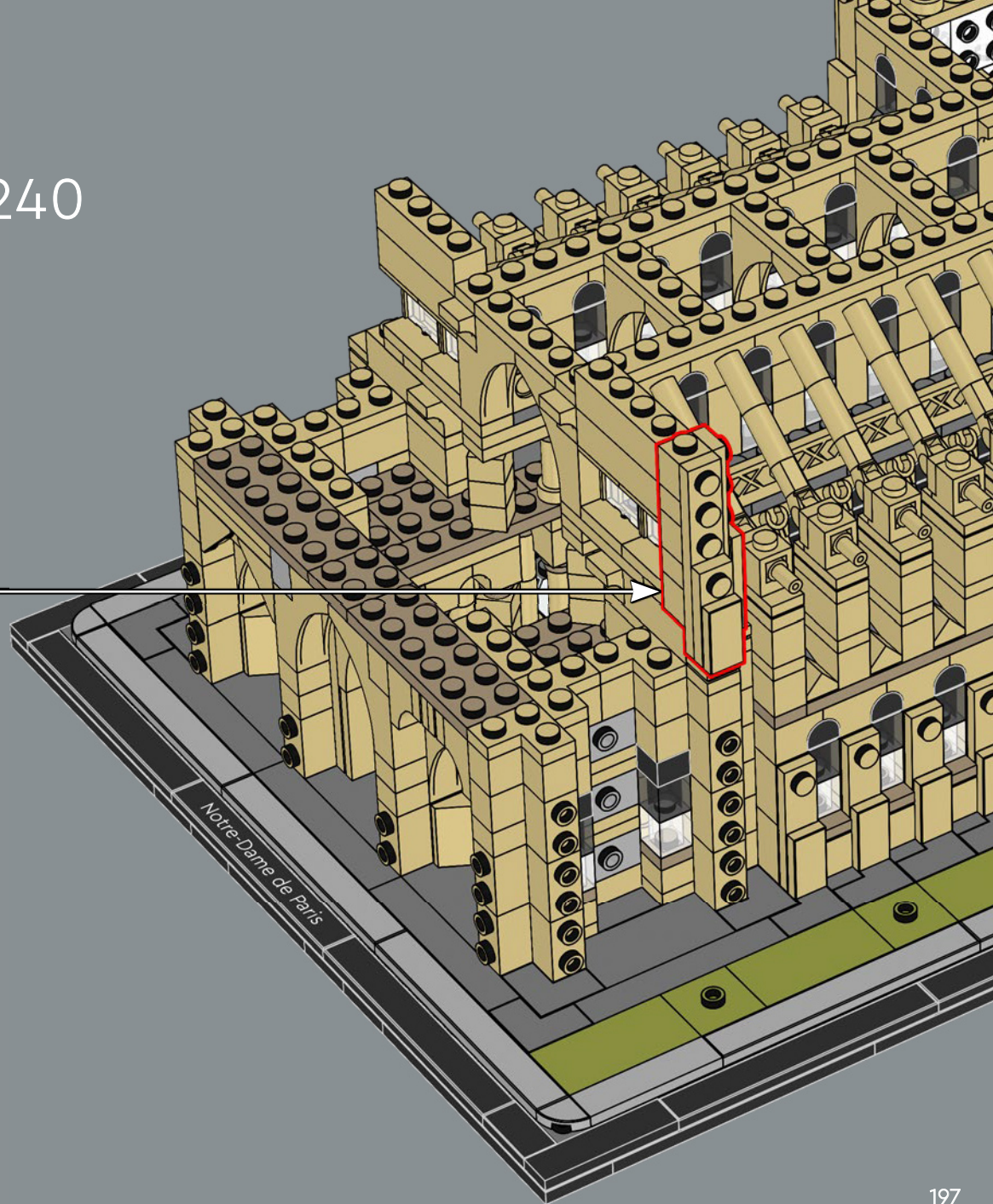

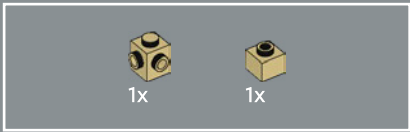

241

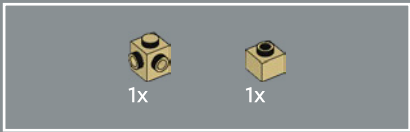
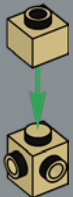

242



243

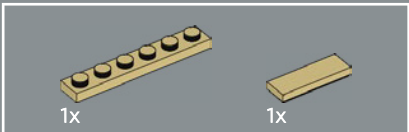

244

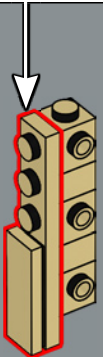
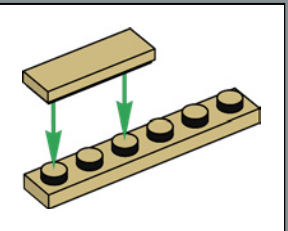

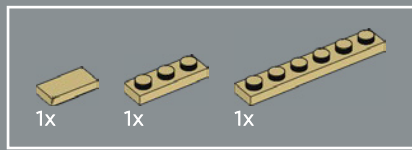

245

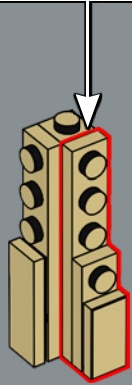
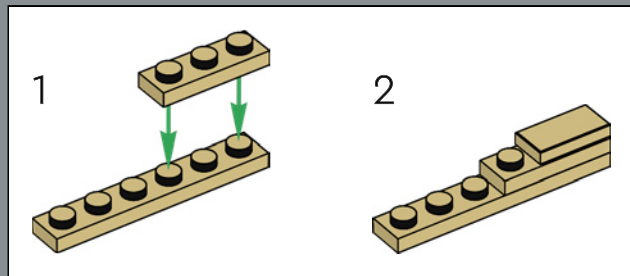

246

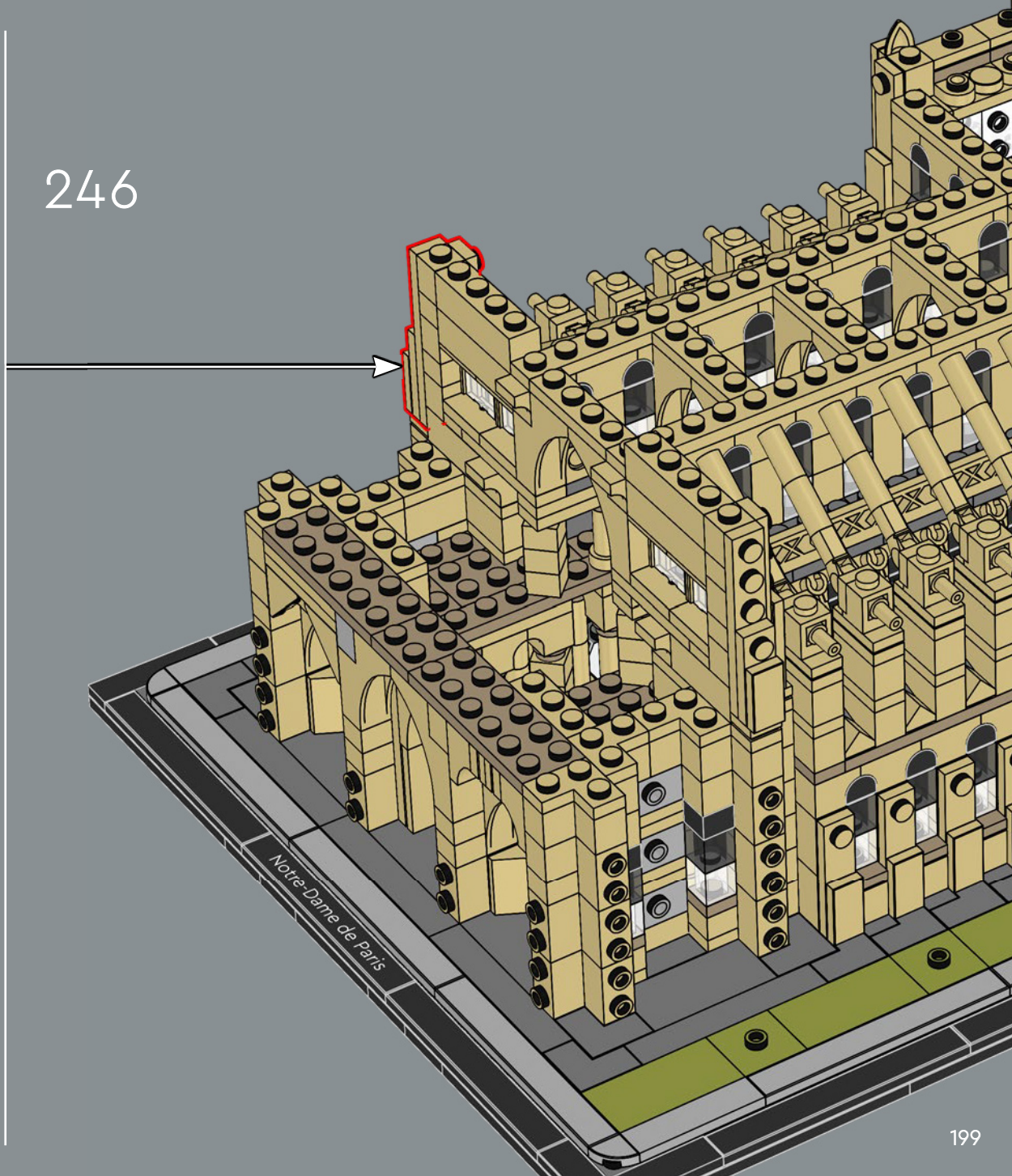



247

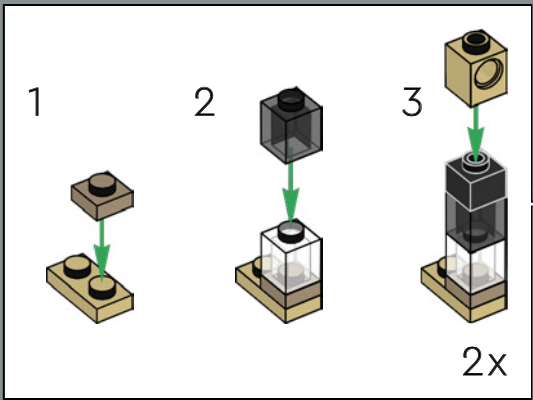

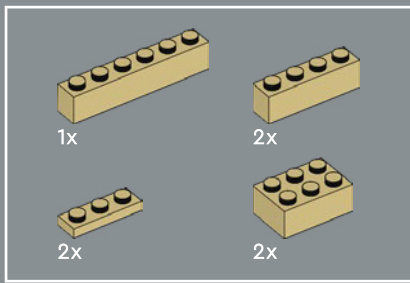

248

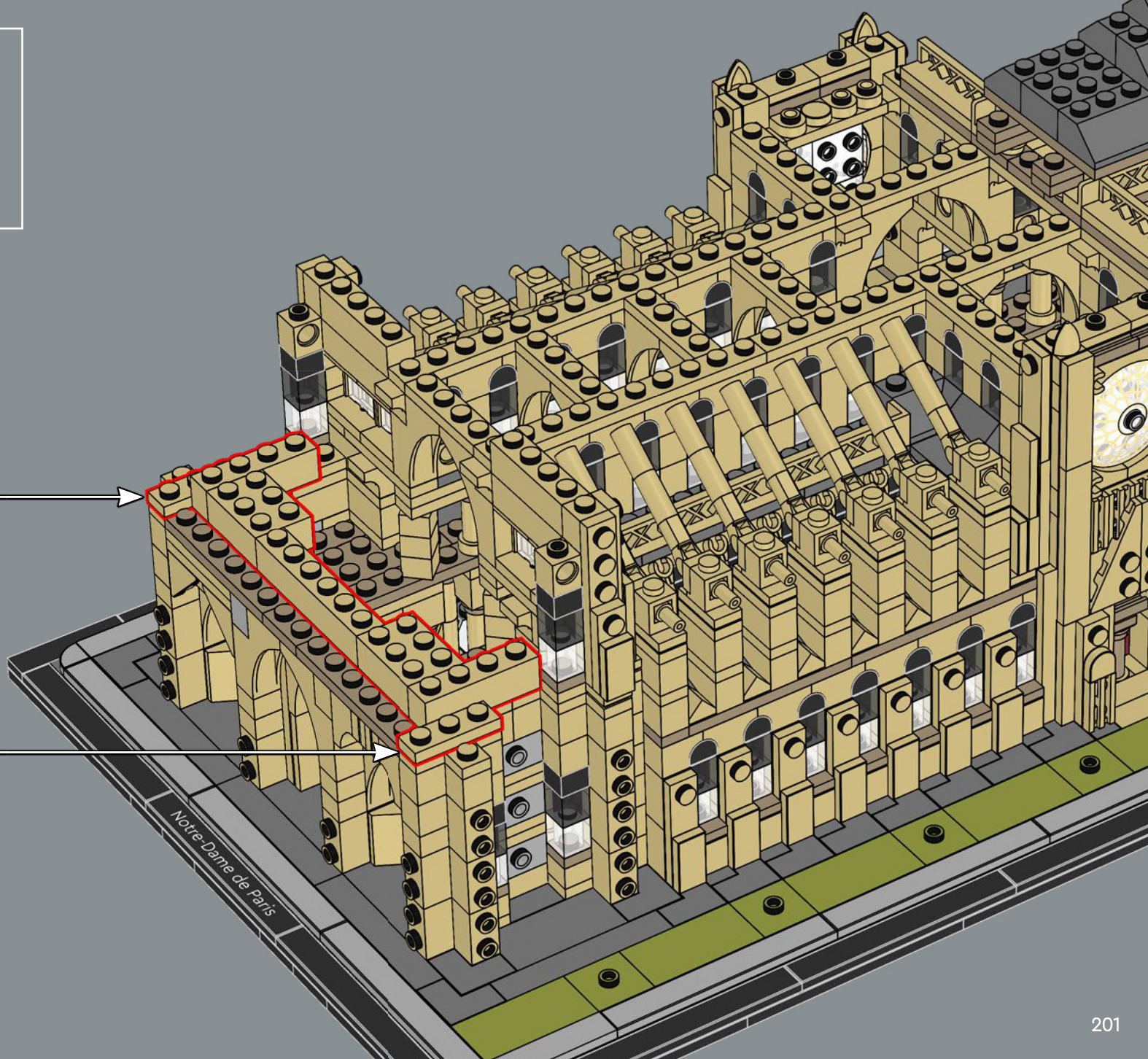
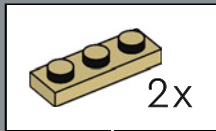

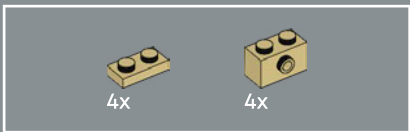

249

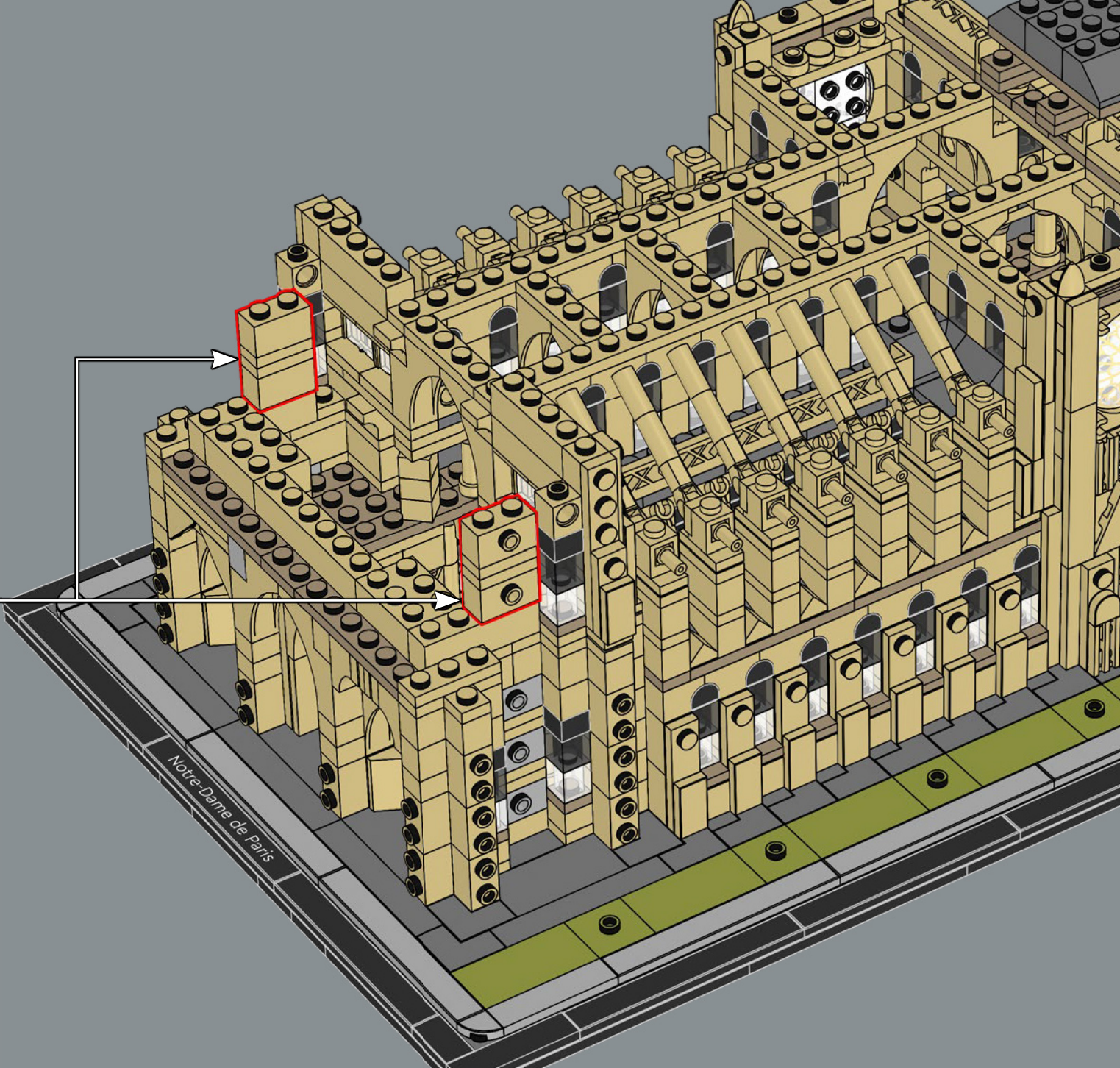
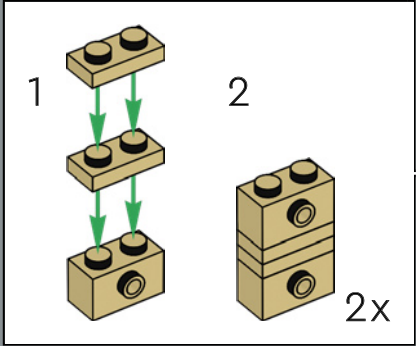

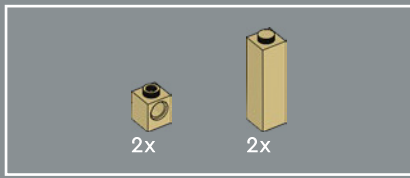

250

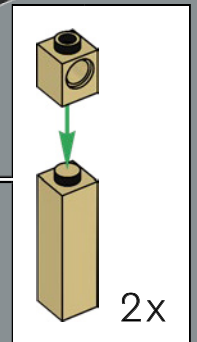
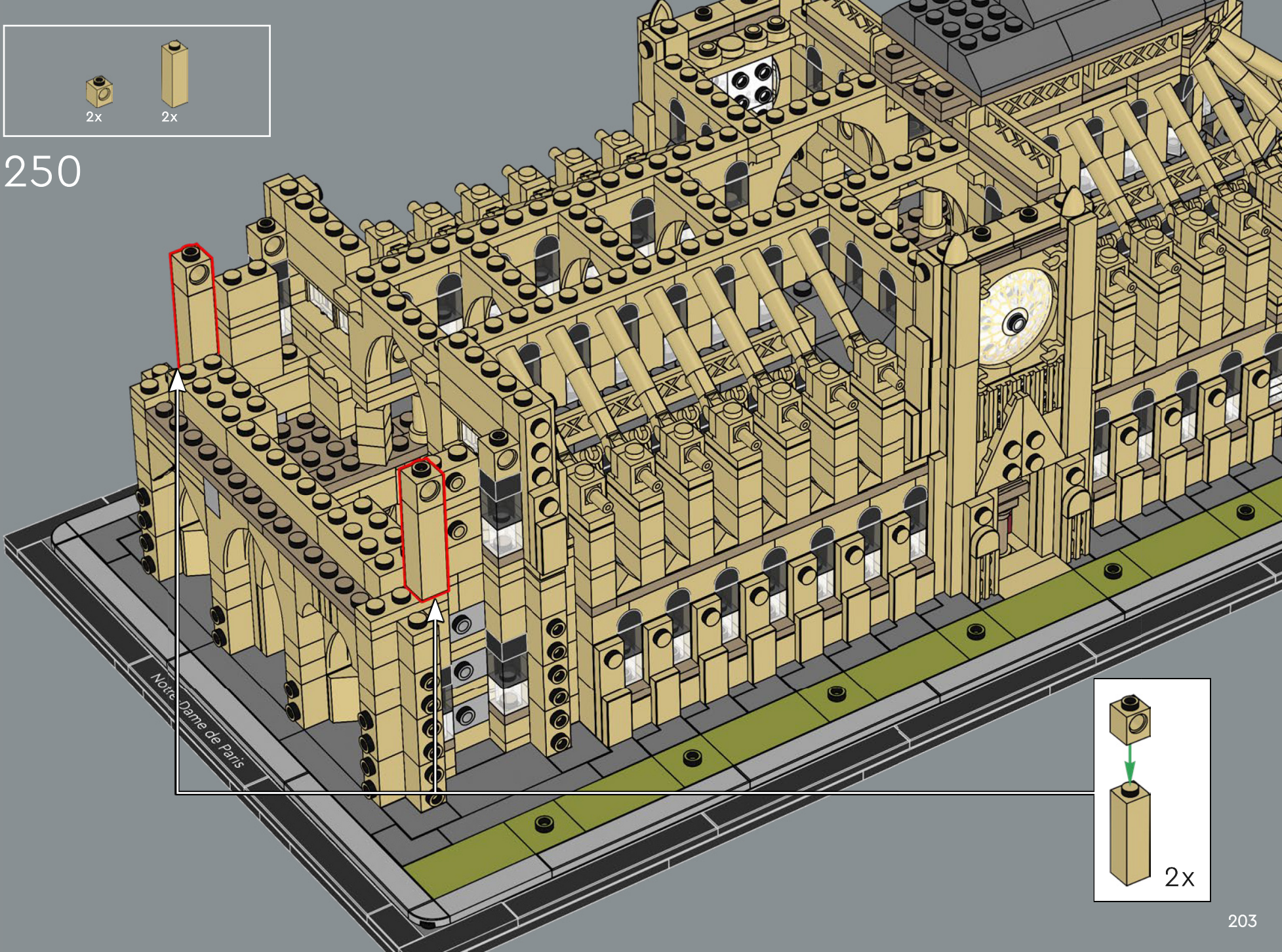

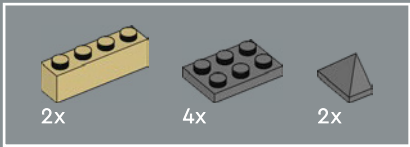

251

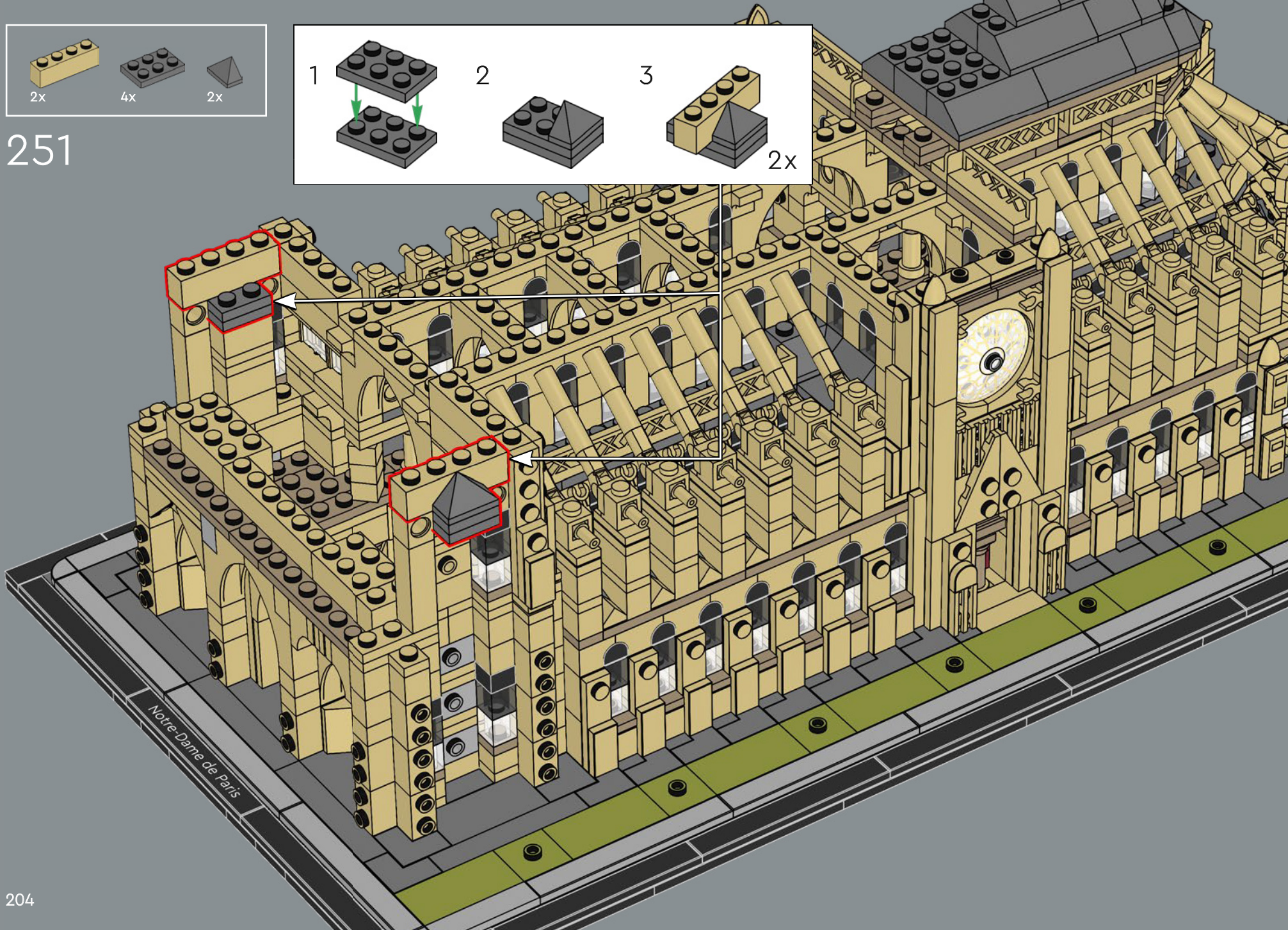
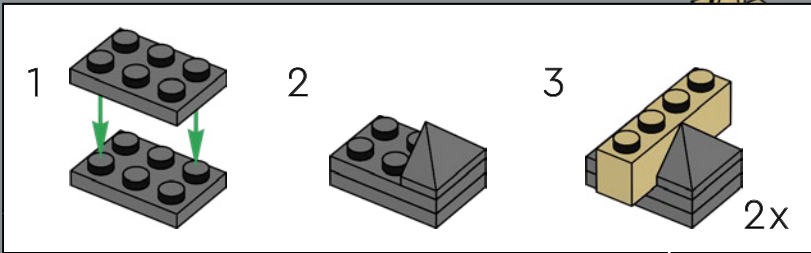

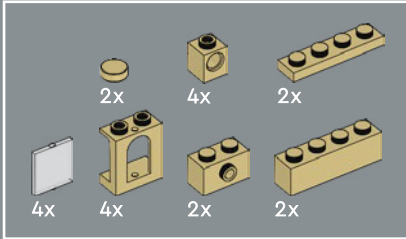
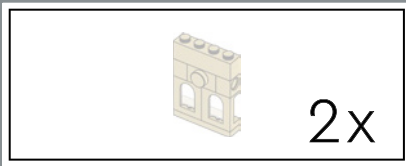

252

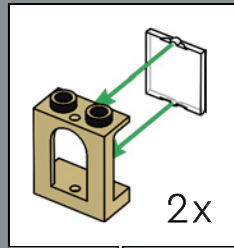

1

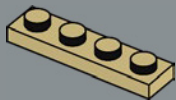

2

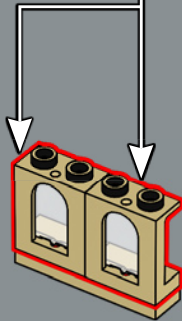

3

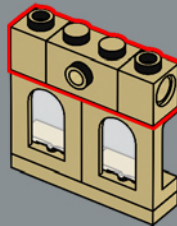

4

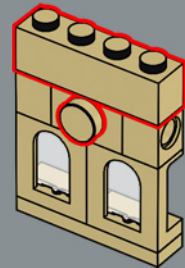

2x

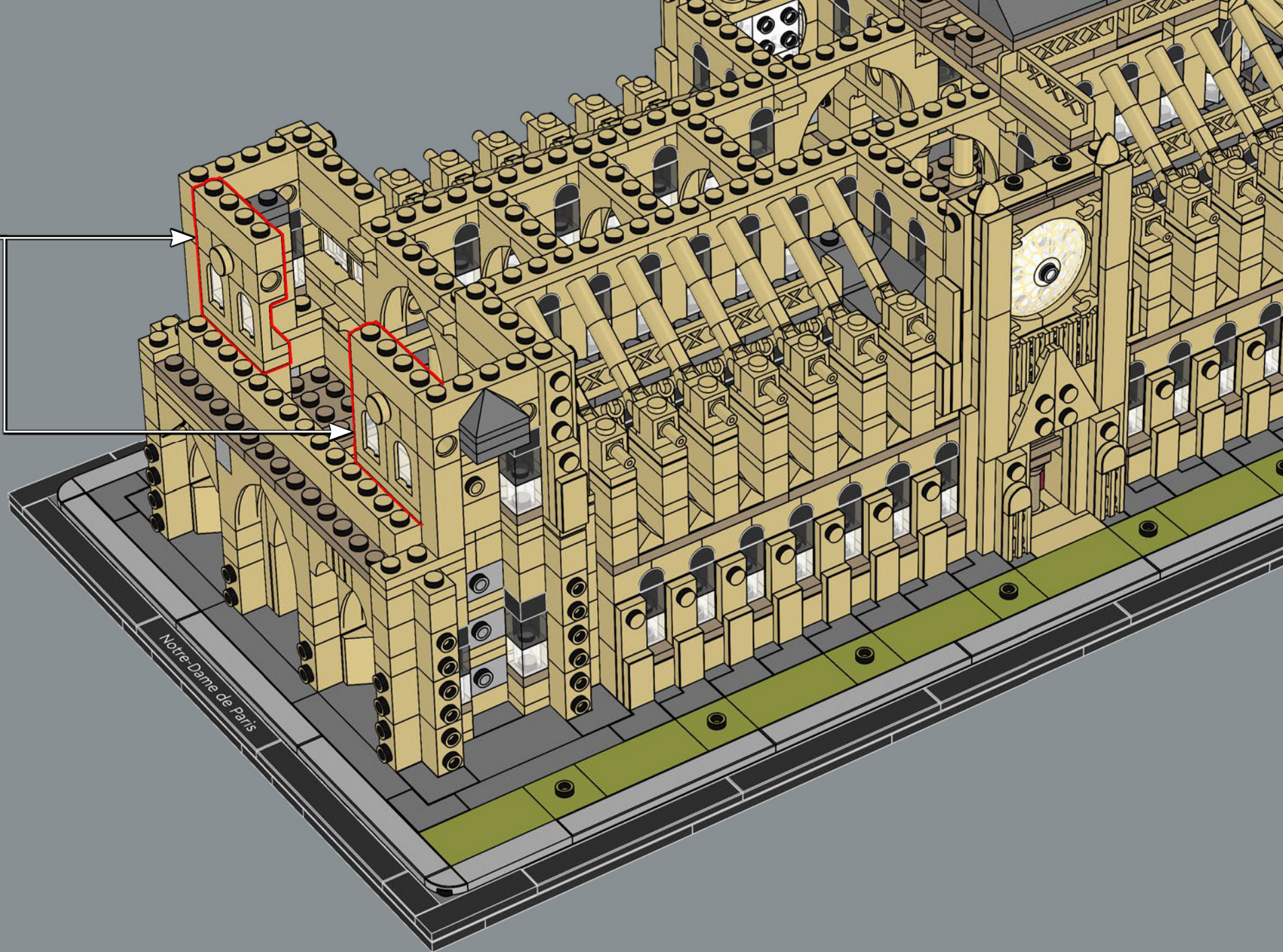

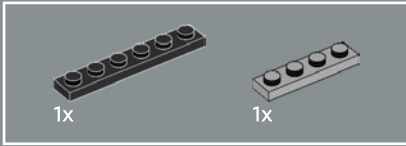
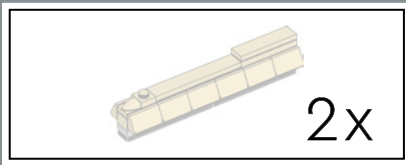

253

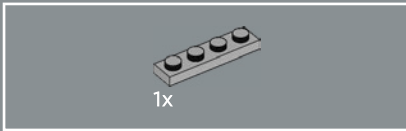
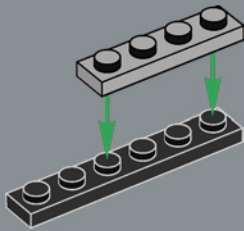

254

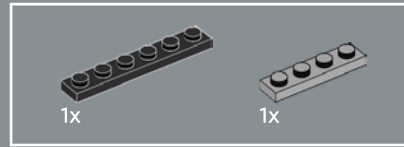
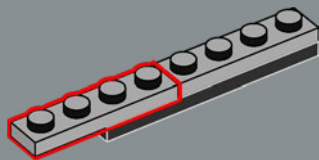

255

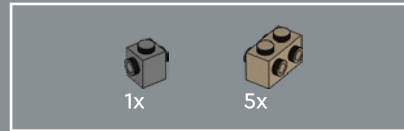
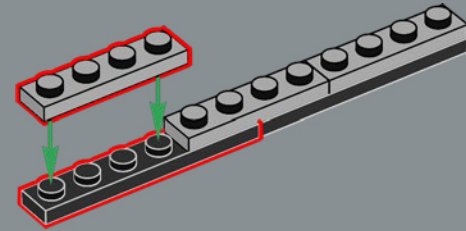

256

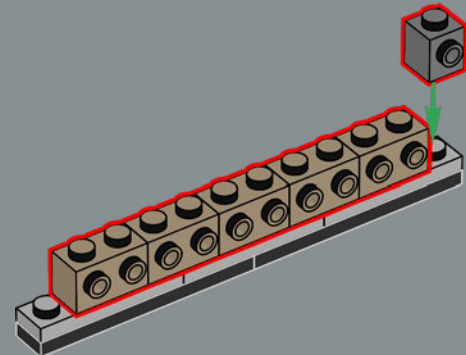

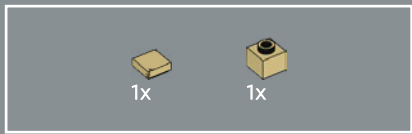

257

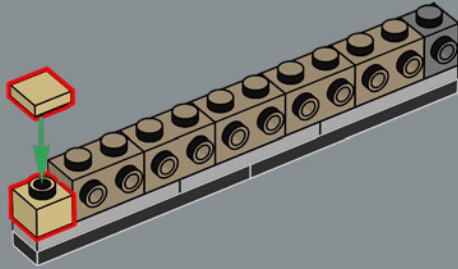

258

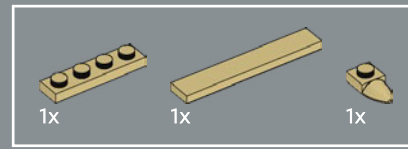
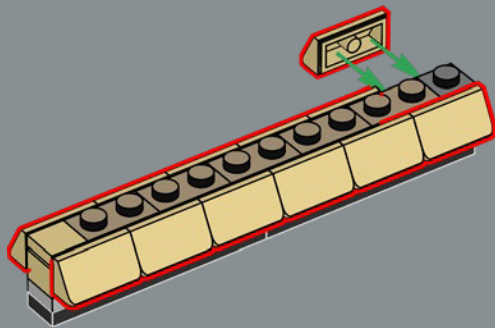

259

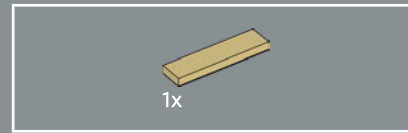
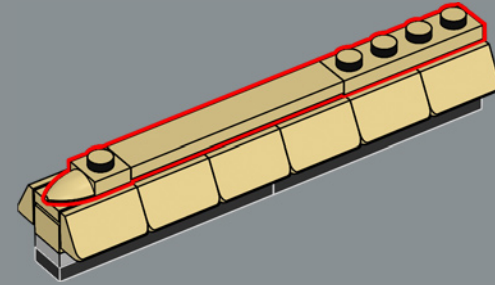

260

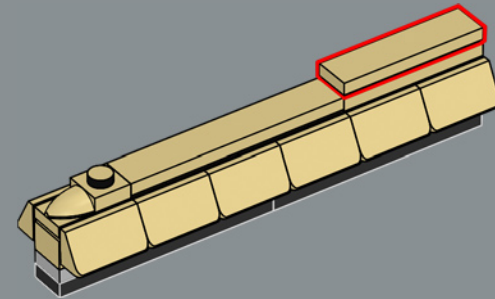

2x

261

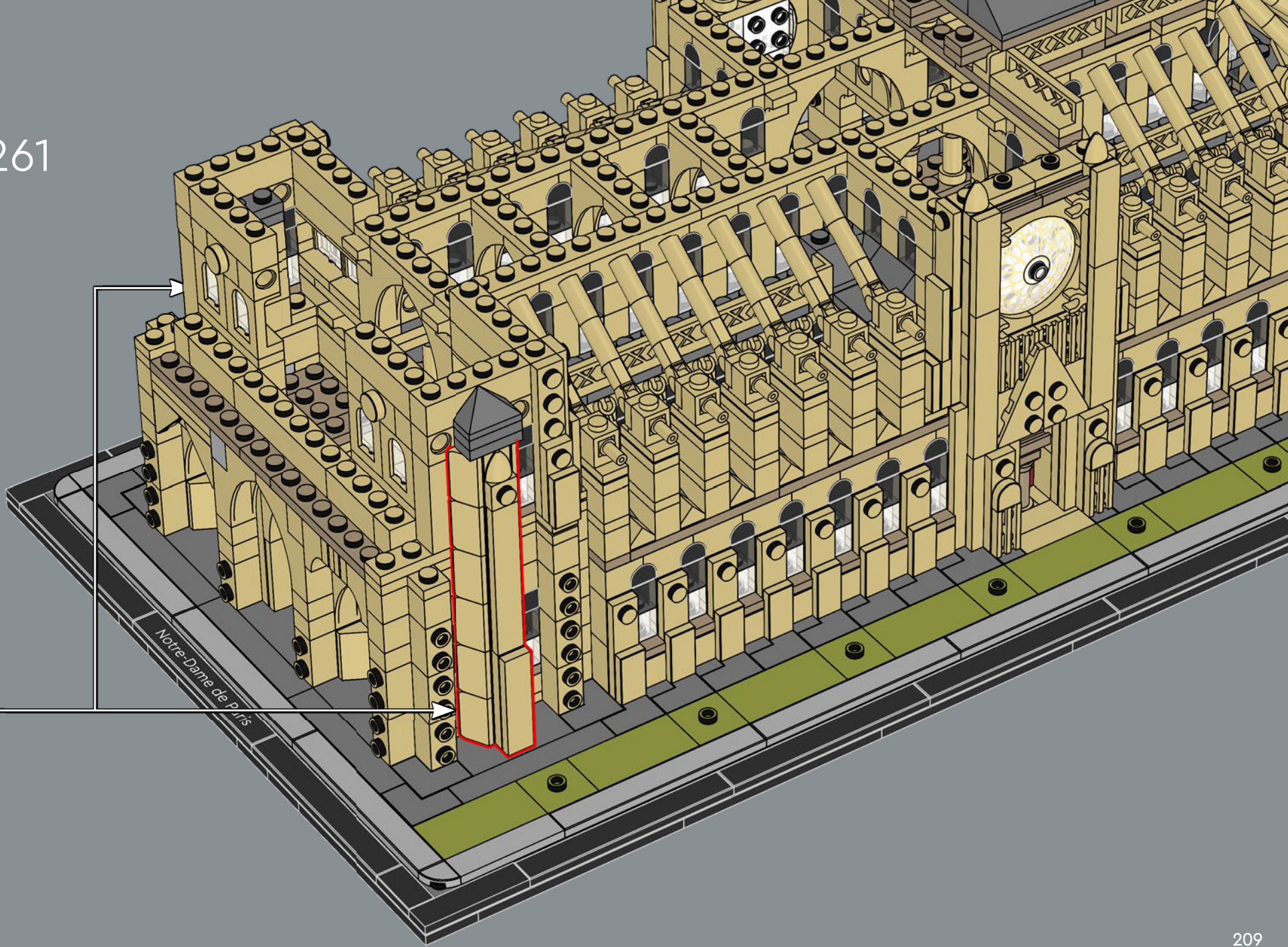

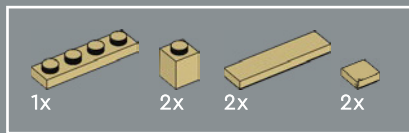

262

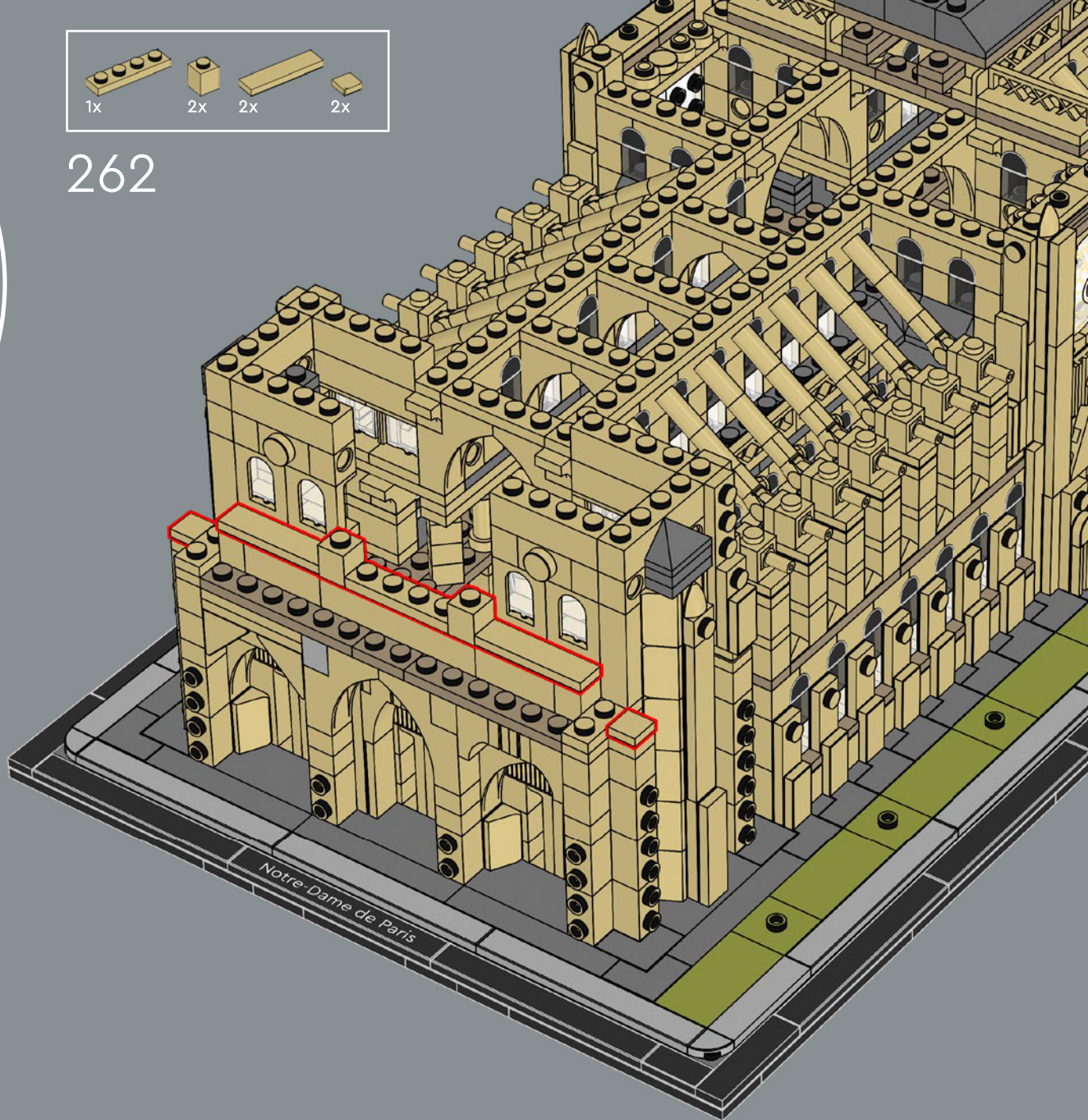



263



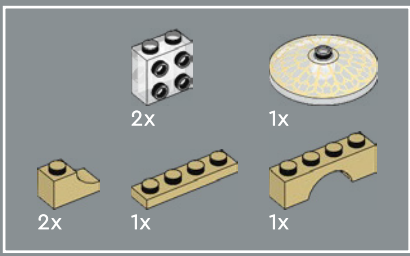

264

1

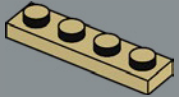

2

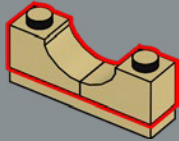

3

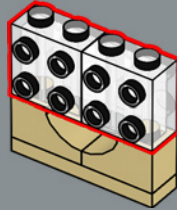

4

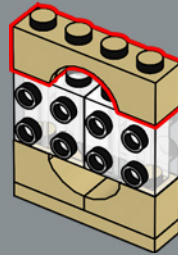

5



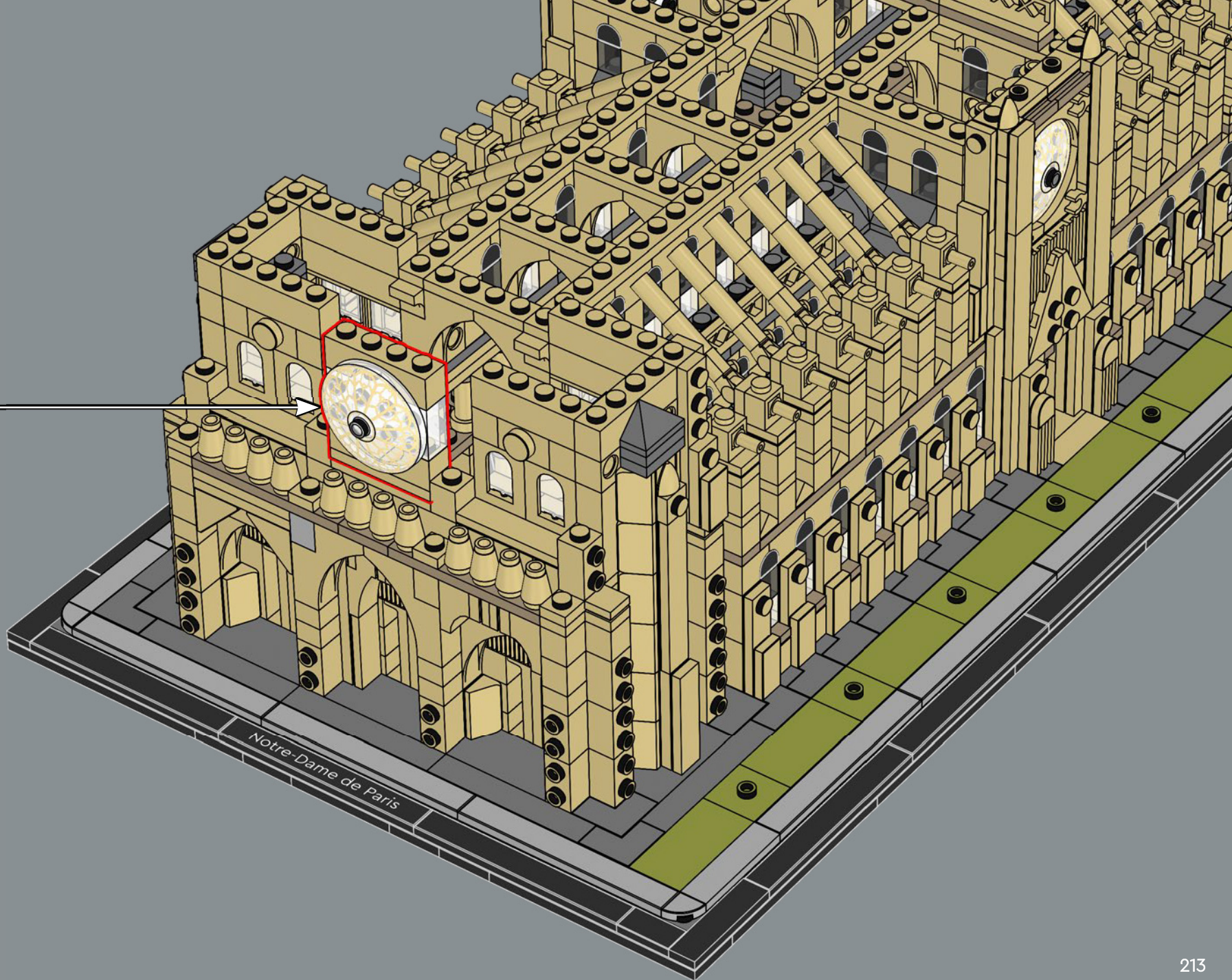

Notre-Dame de Paris

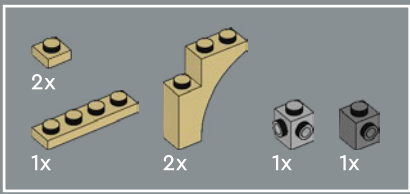

265

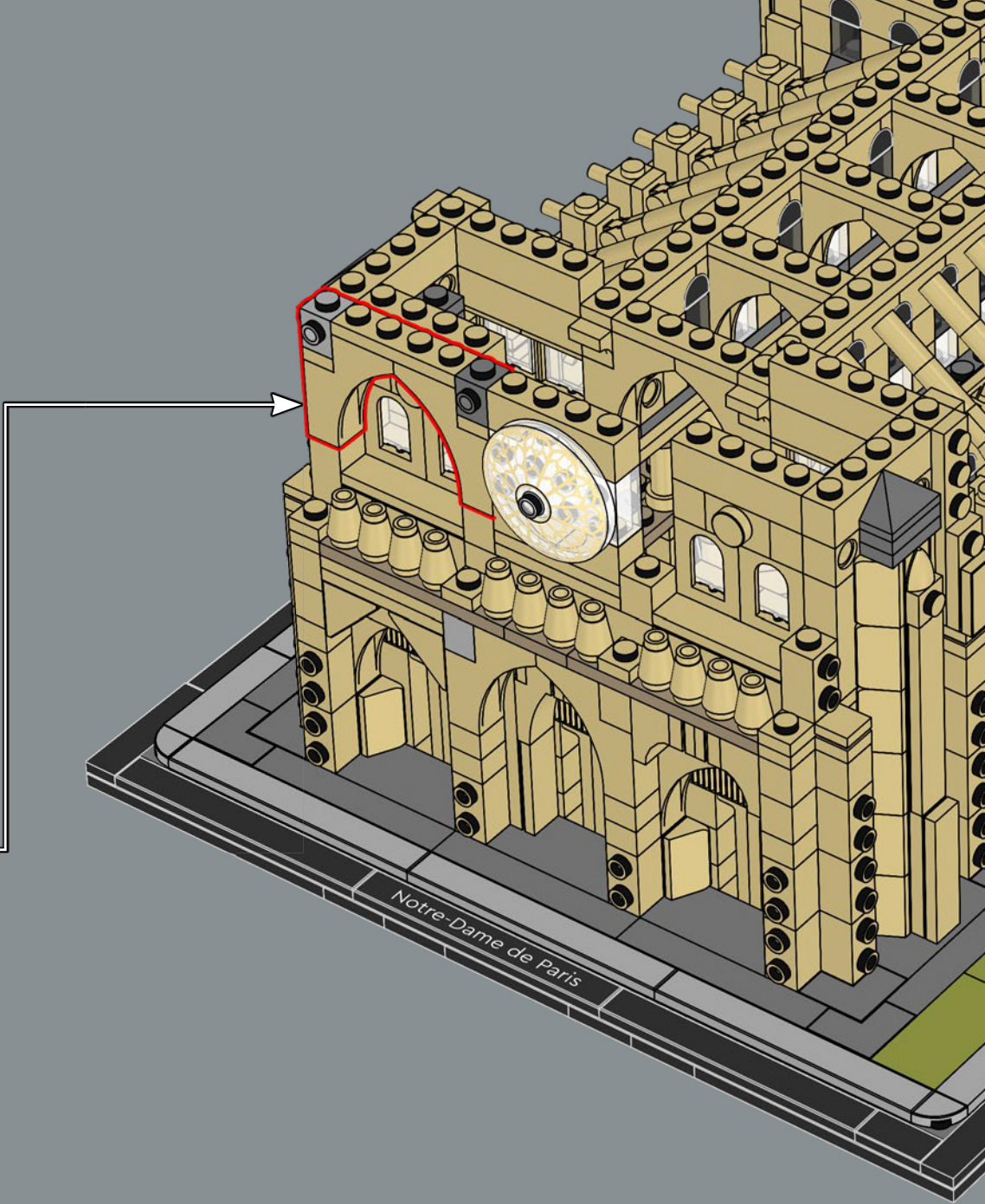
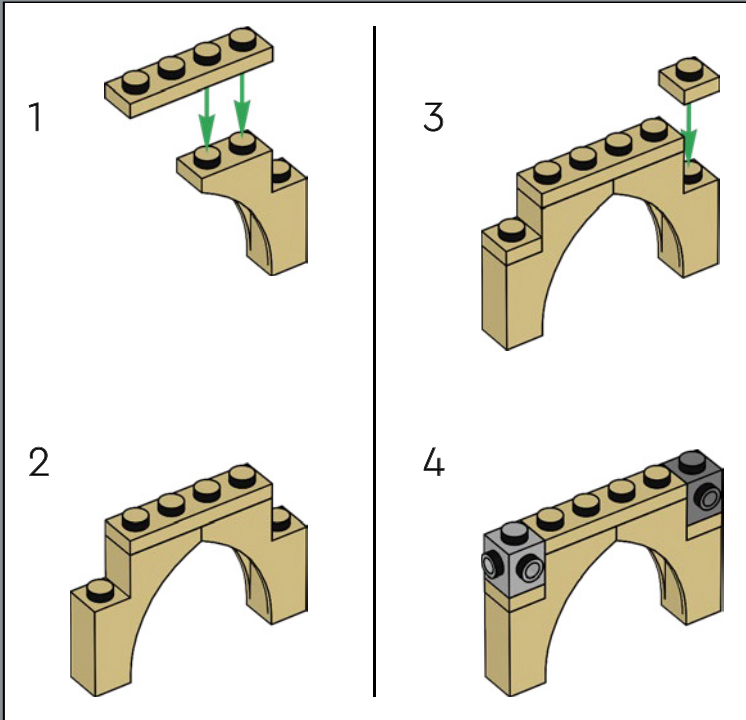

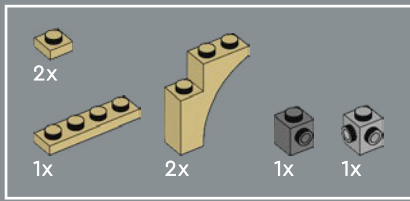

266

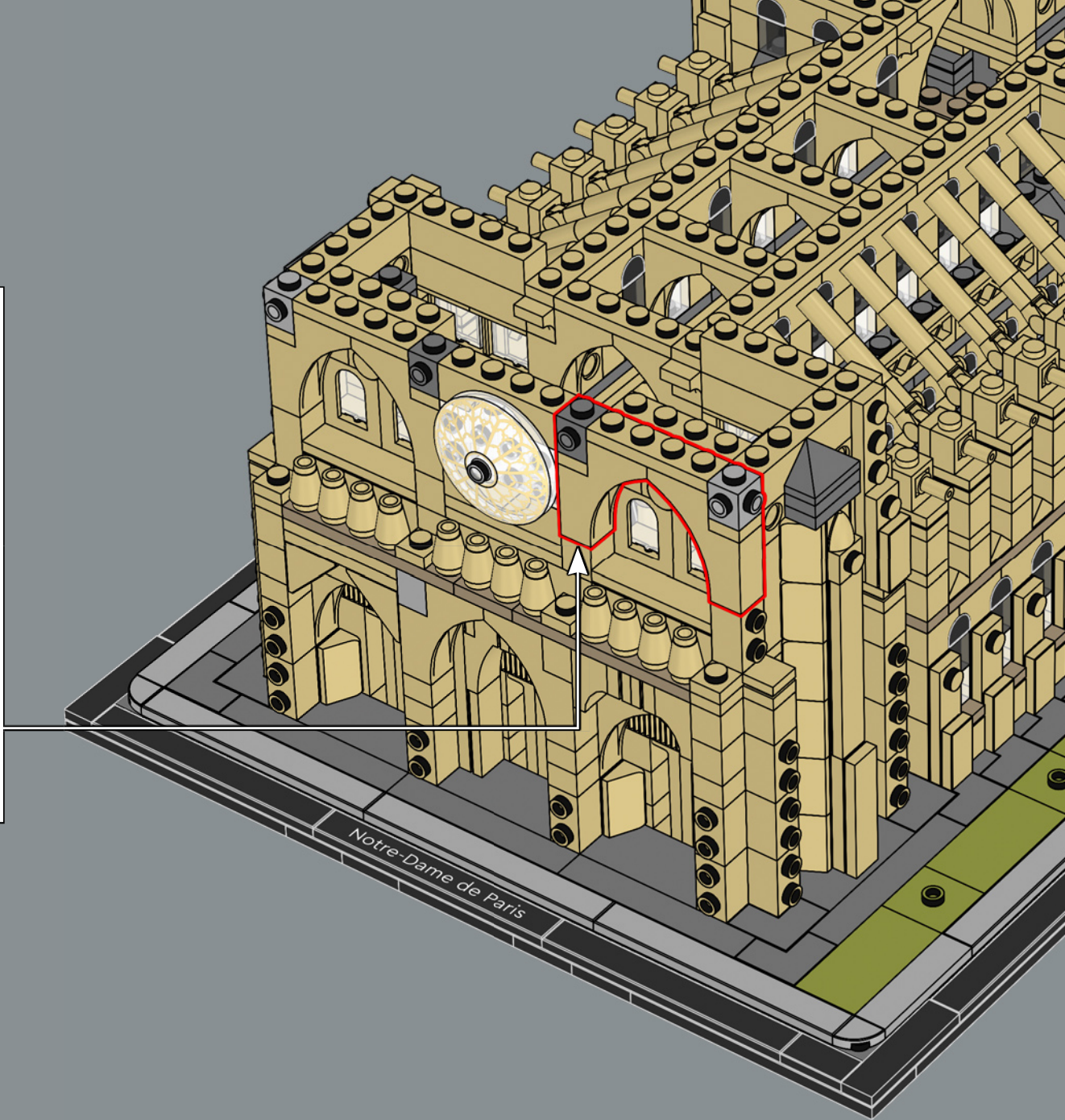
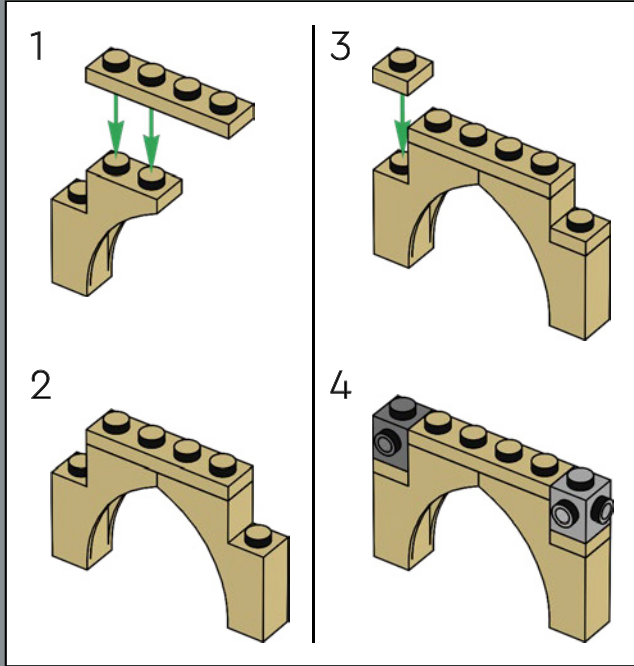

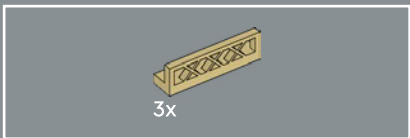

267

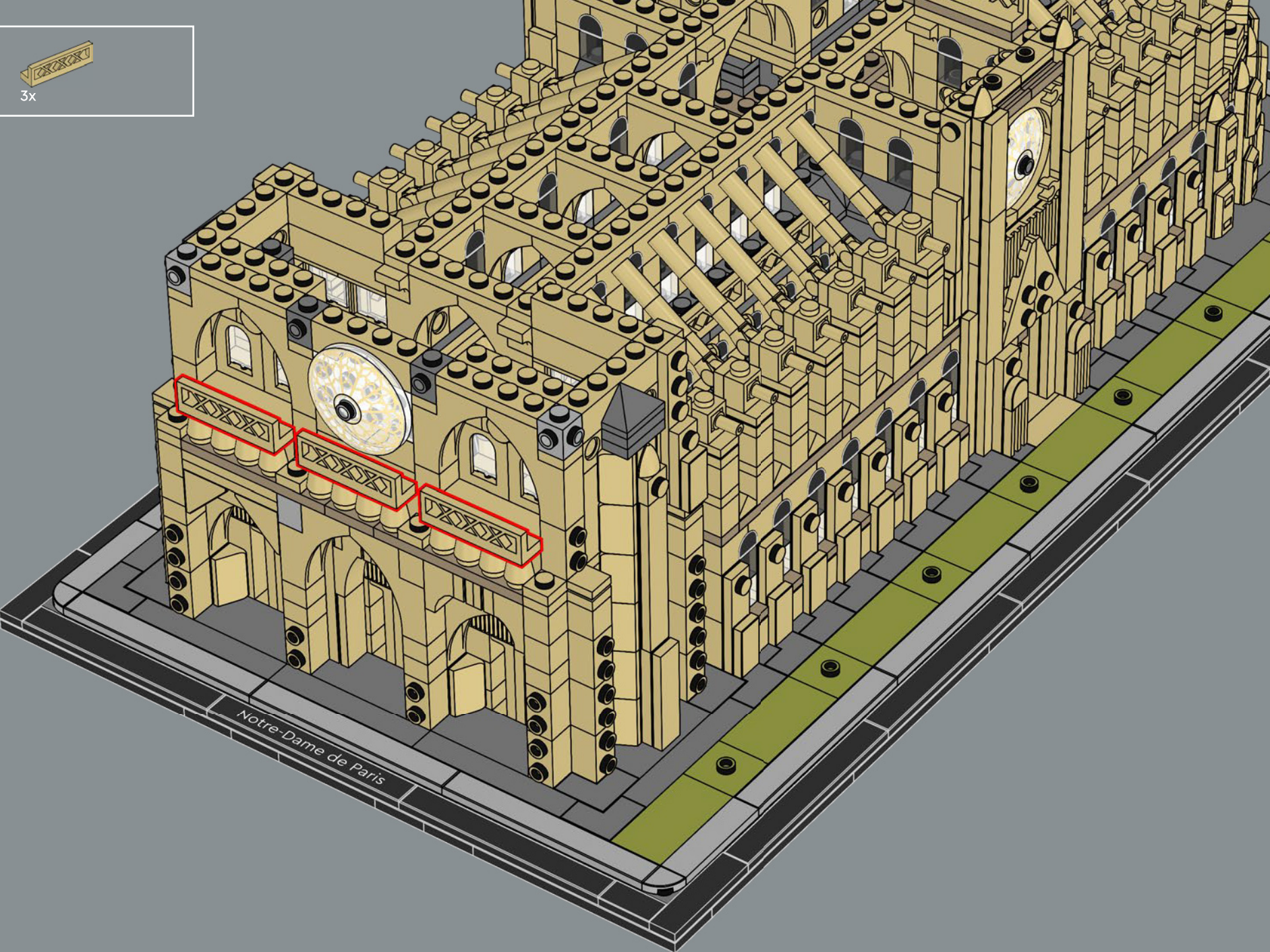

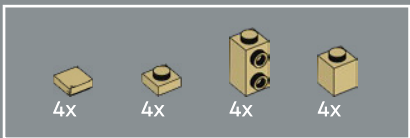

268

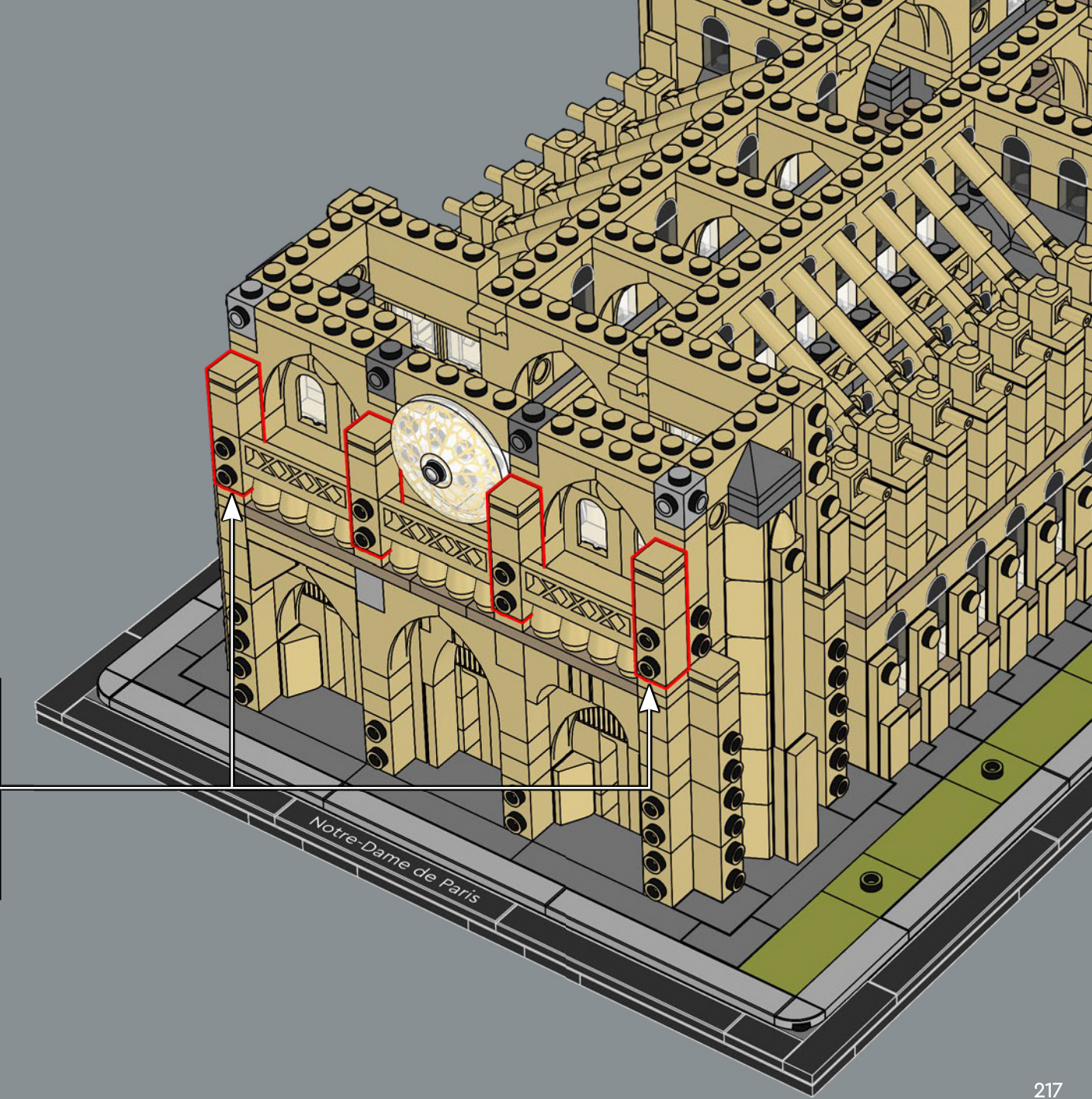
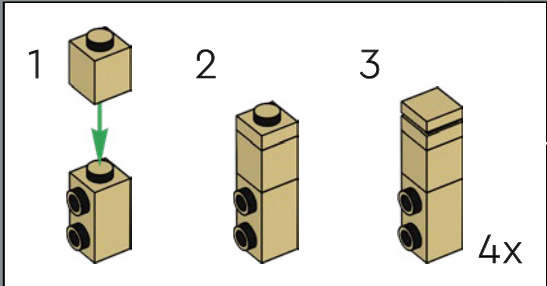

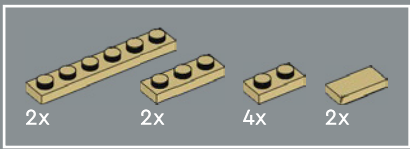

269

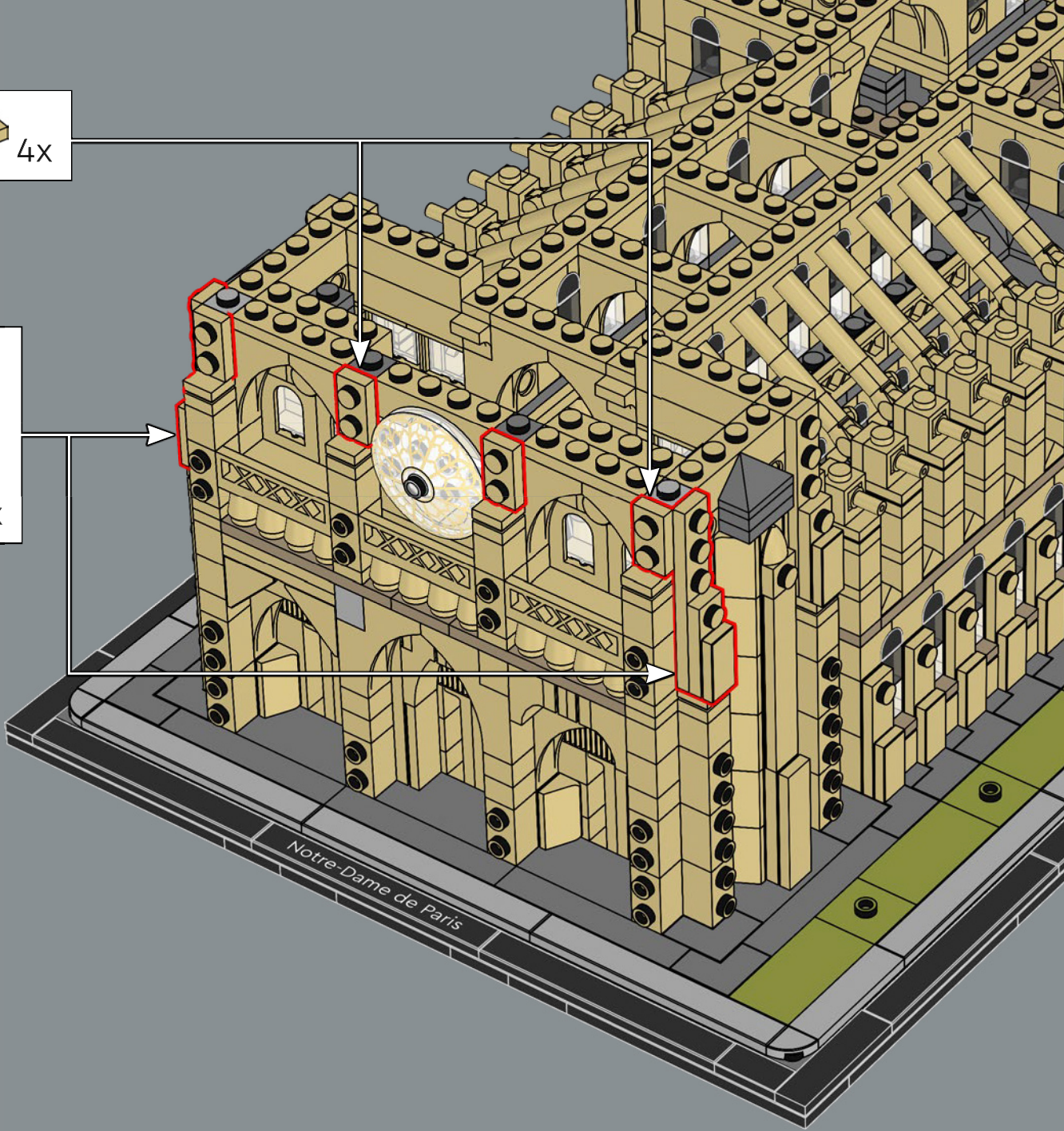
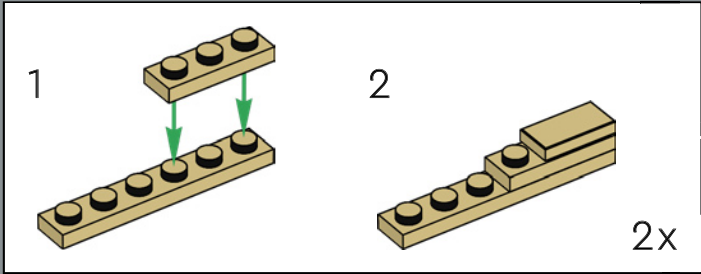
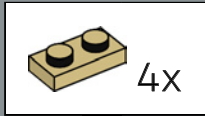

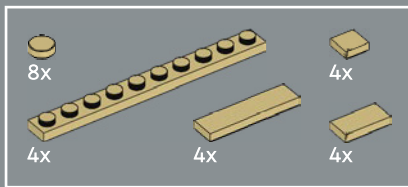

1220: La majestuosa entrada de la catedral, coronada por la Galería de los Reyes, da la bienvenida a los visitantes con tres portales. Las 28 colosales estatuas están representadas por 20 conos y elementos redondos LEGO®.

270

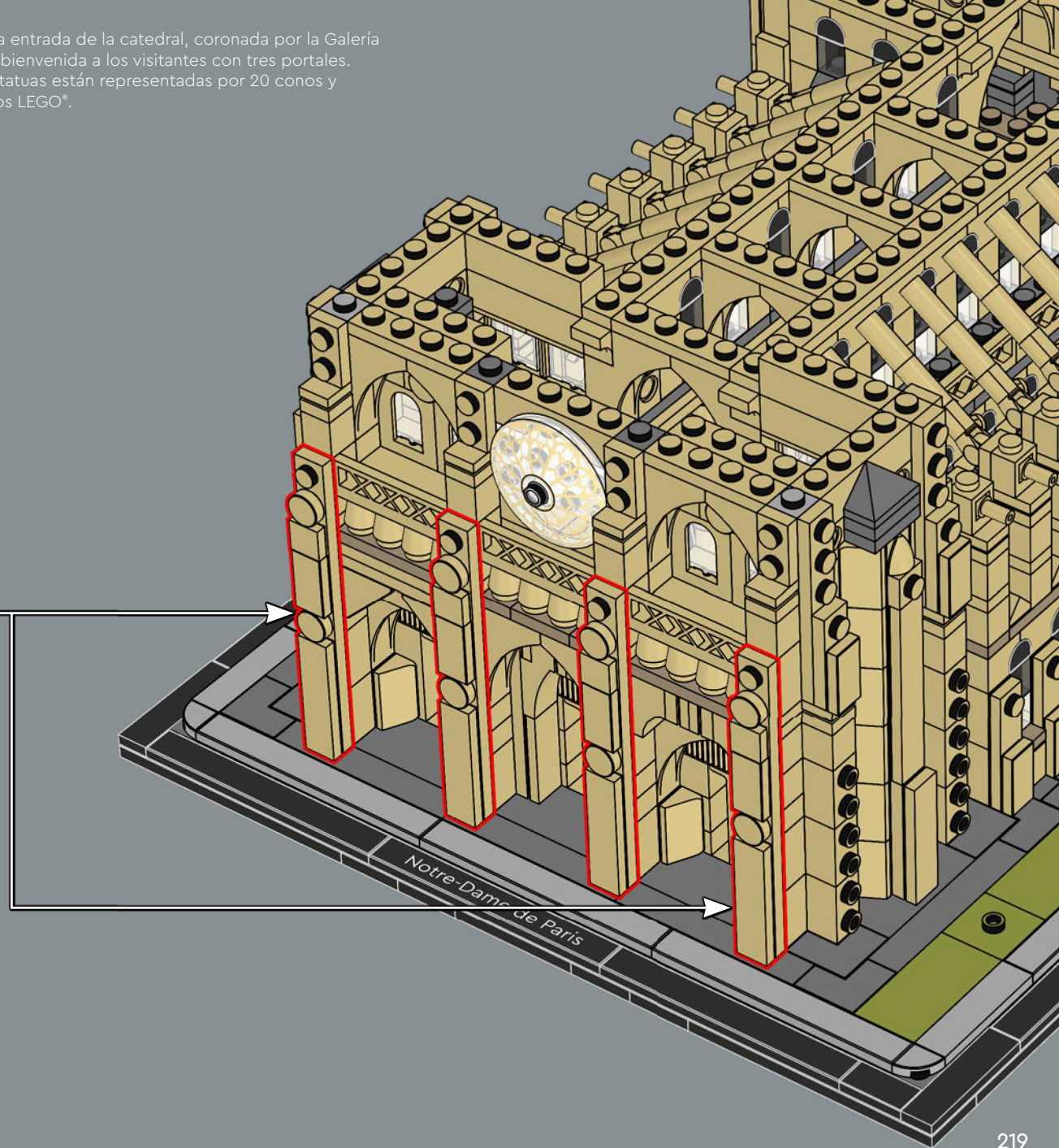
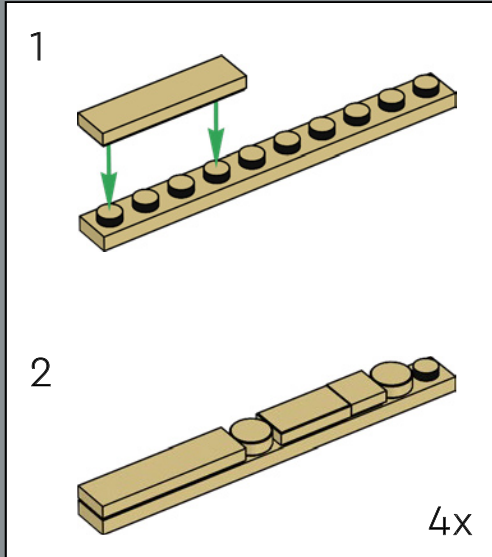

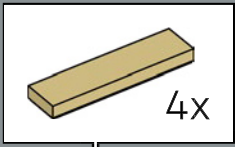
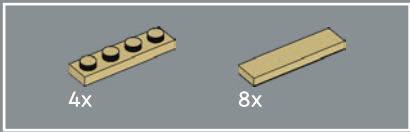

271

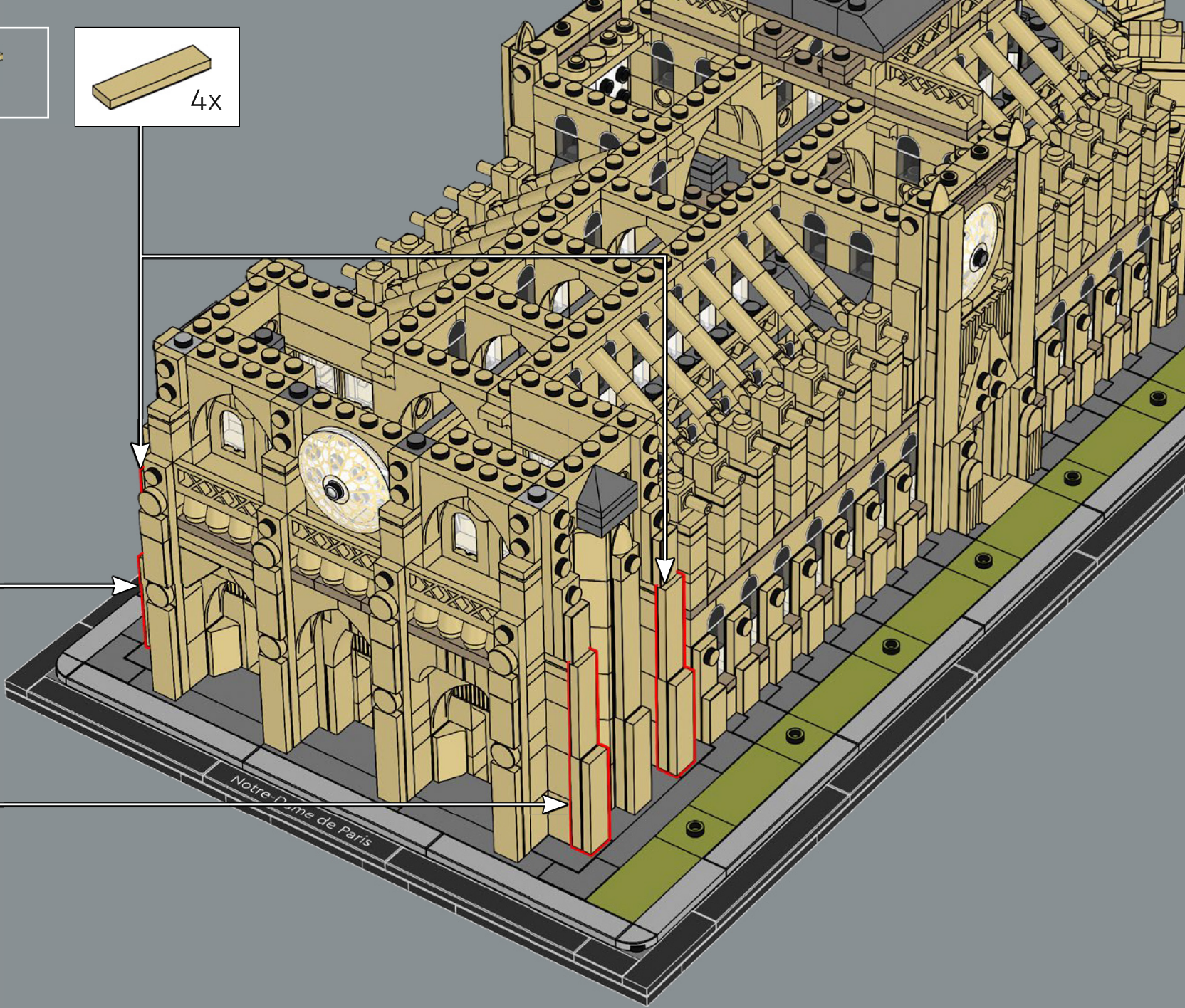
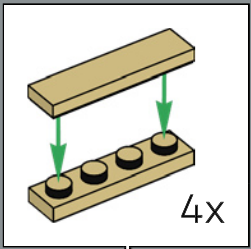

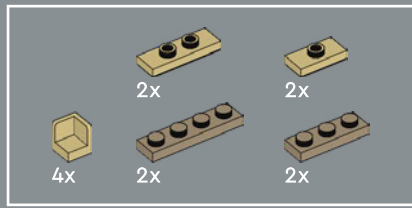

272

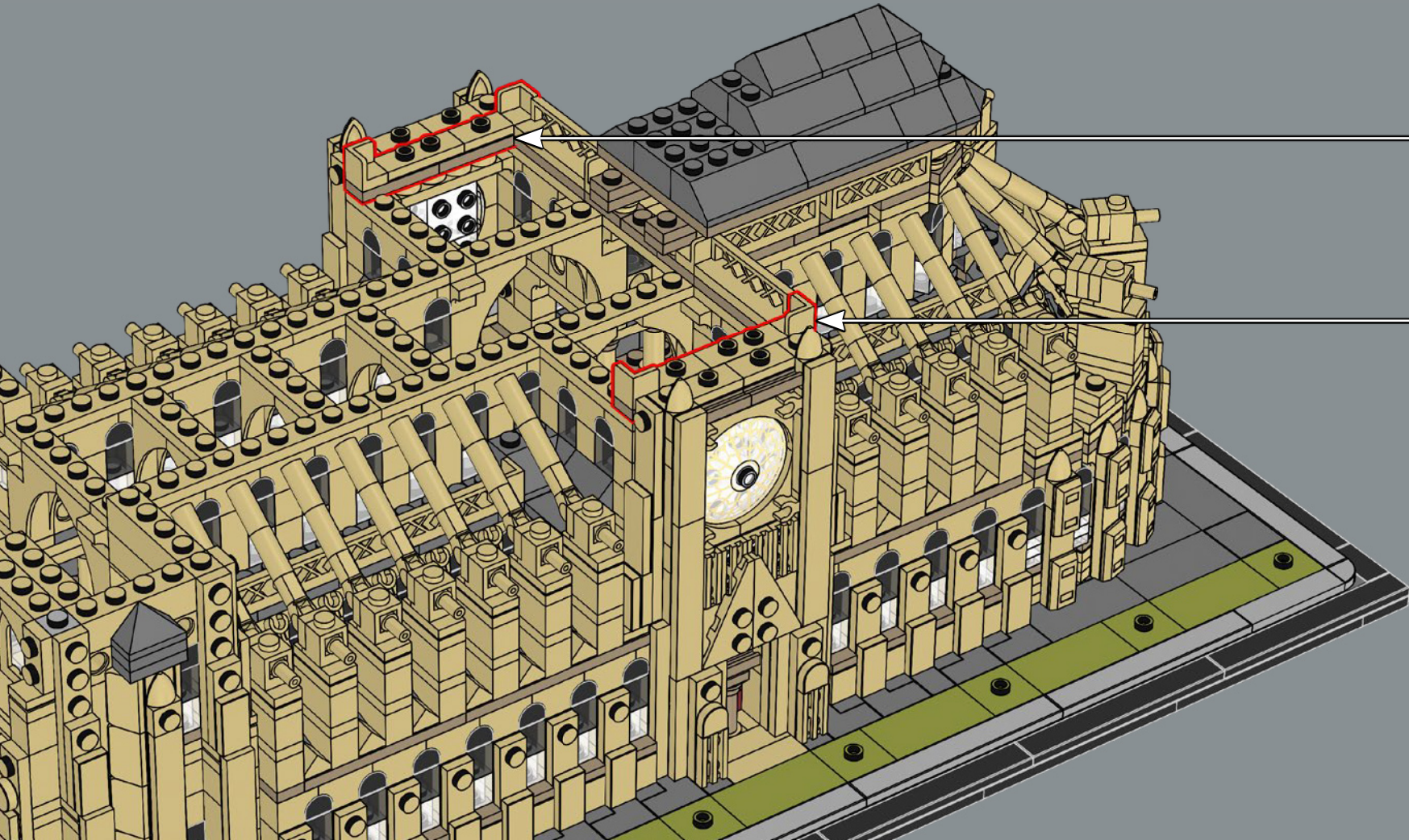
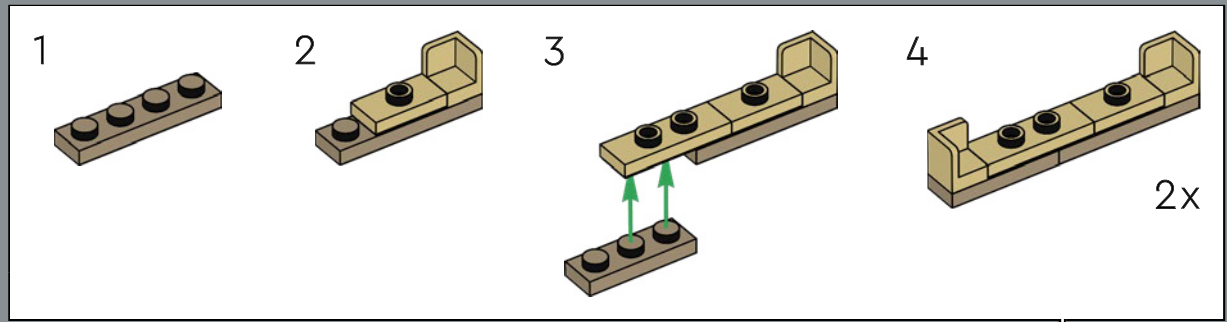

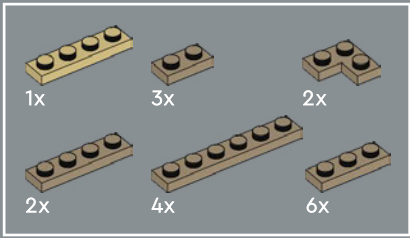

273

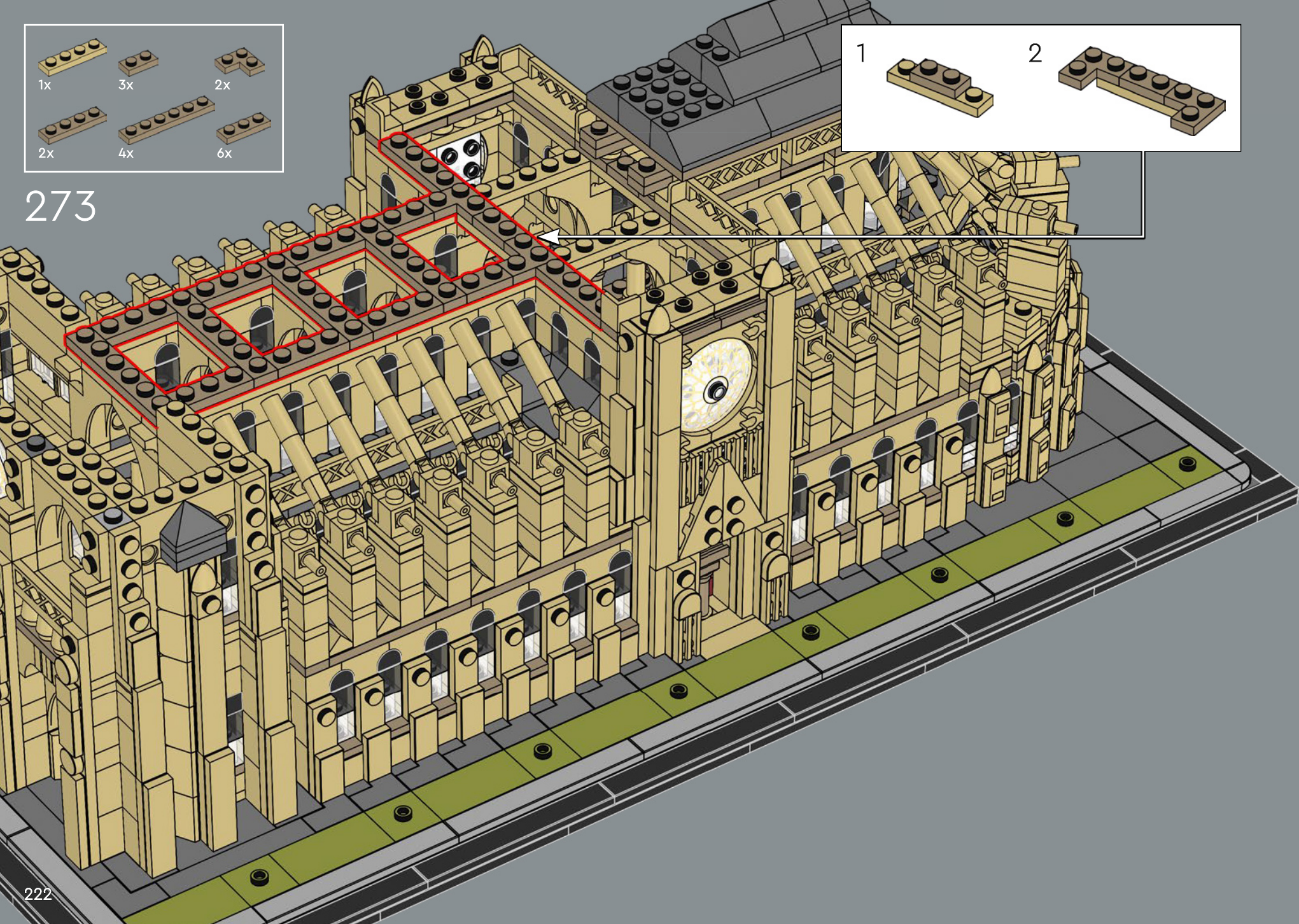
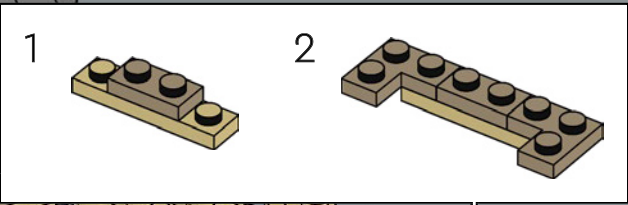

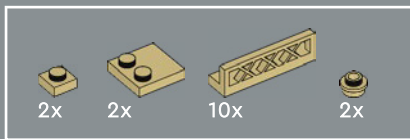

274

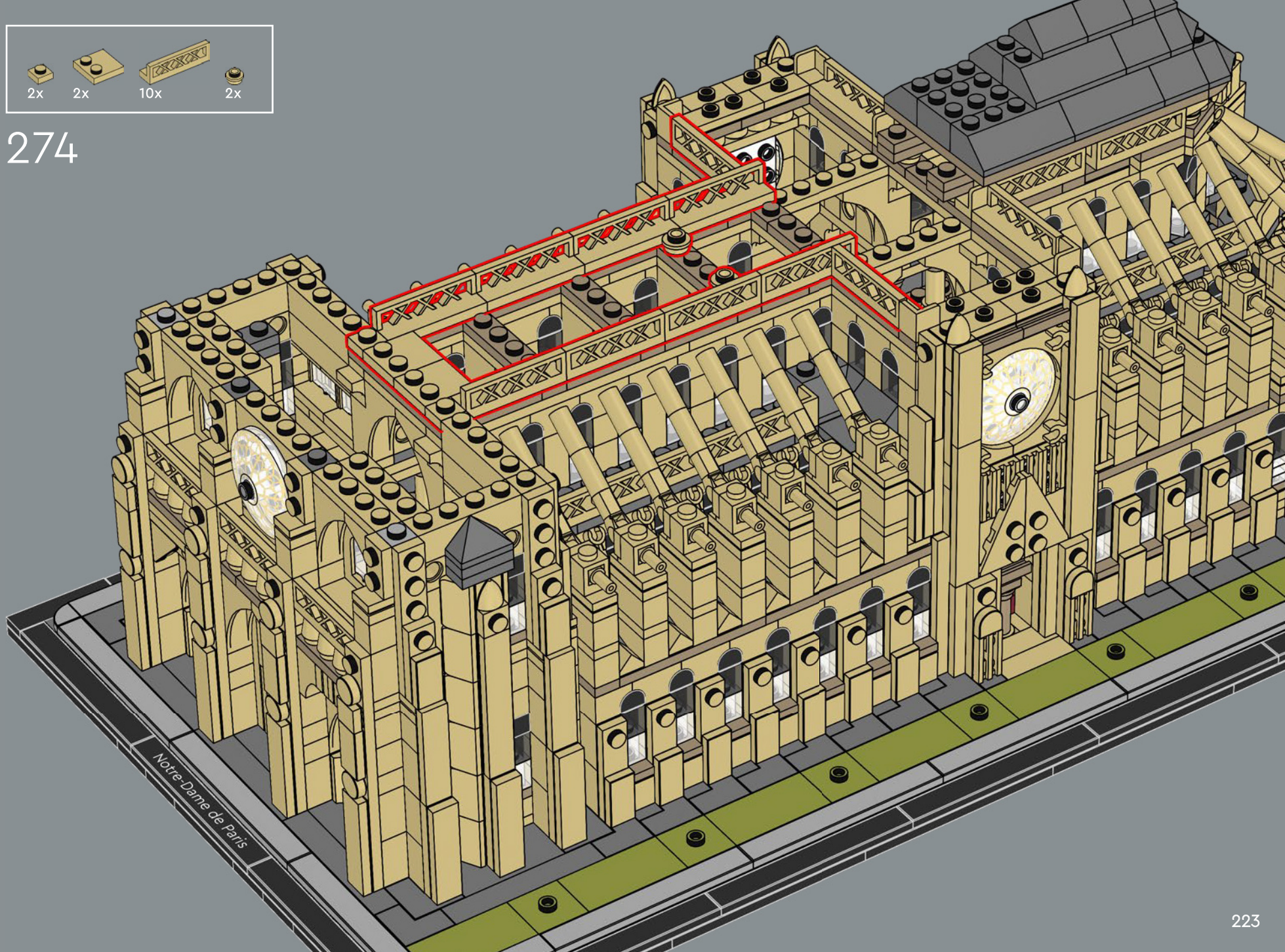



LA TRANSFORMACIÓN CONTINÚA

✂ Para 1245, todas las torres estaban terminadas. Mientras construyes las torres, puedes apreciar parte del mecanismo interno del campanario de la catedral y la superestructura que soporta las legendarias campanas. A lo largo de los cinco siglos siguientes, el desgaste se hizo presente de múltiples formas. Nuevas generaciones de arquitectos supervisaron numerosas modificaciones, reparaciones y adiciones, como la aguja de madera cubierta de plomo que se construyó sobre la nave transversal. En 1300, se añadieron las capillas al perímetro del coro.



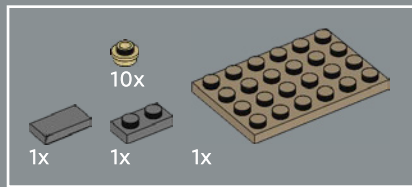

275

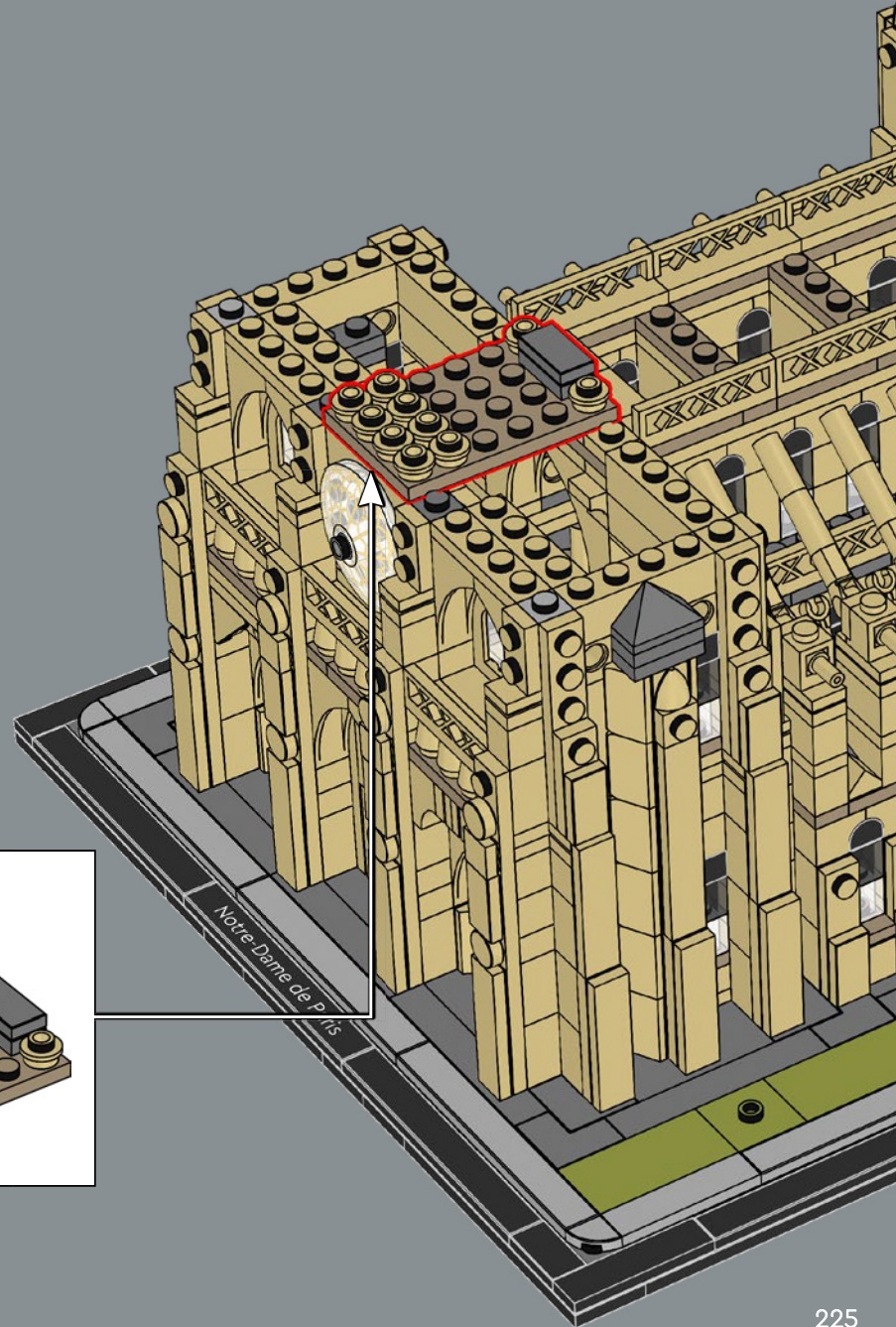
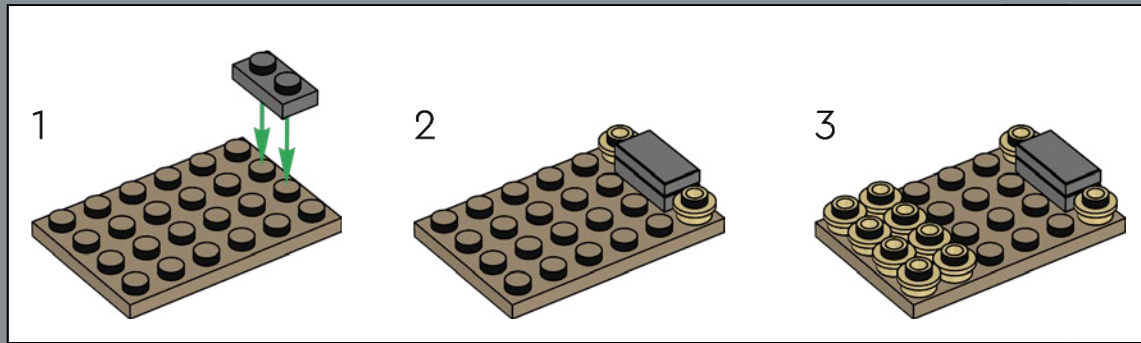

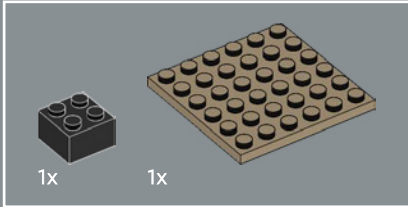
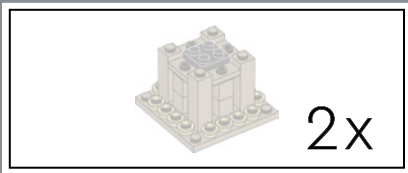

276

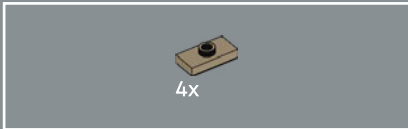
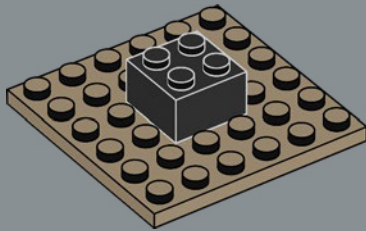

277

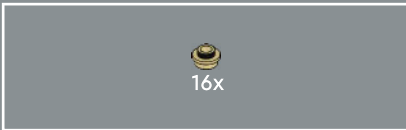
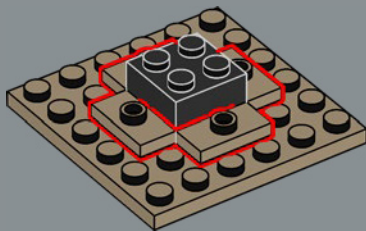

278

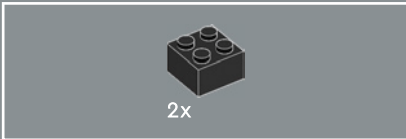
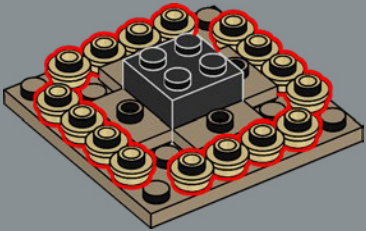

279

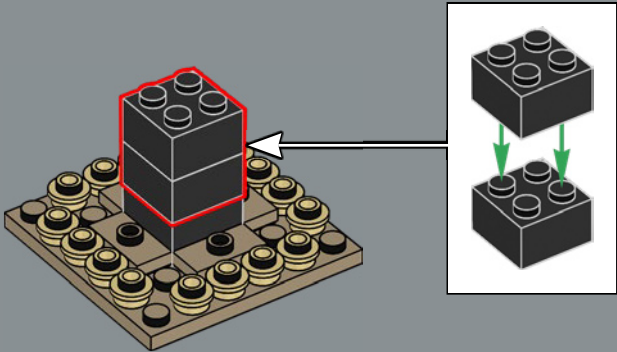



280

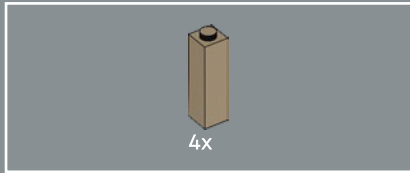
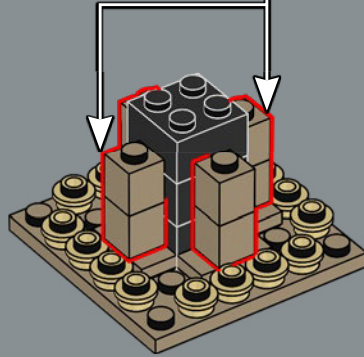
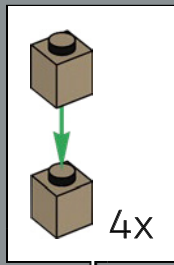

281

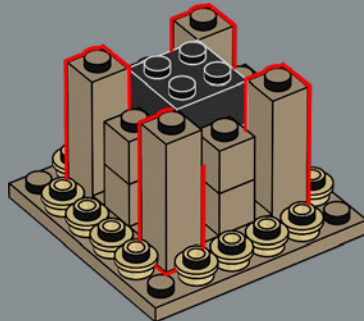

282

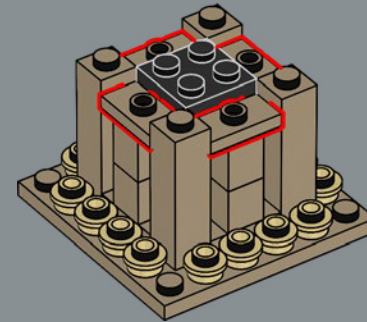

2x

283



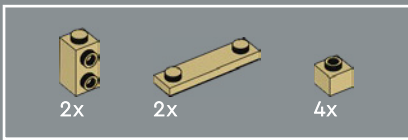

284

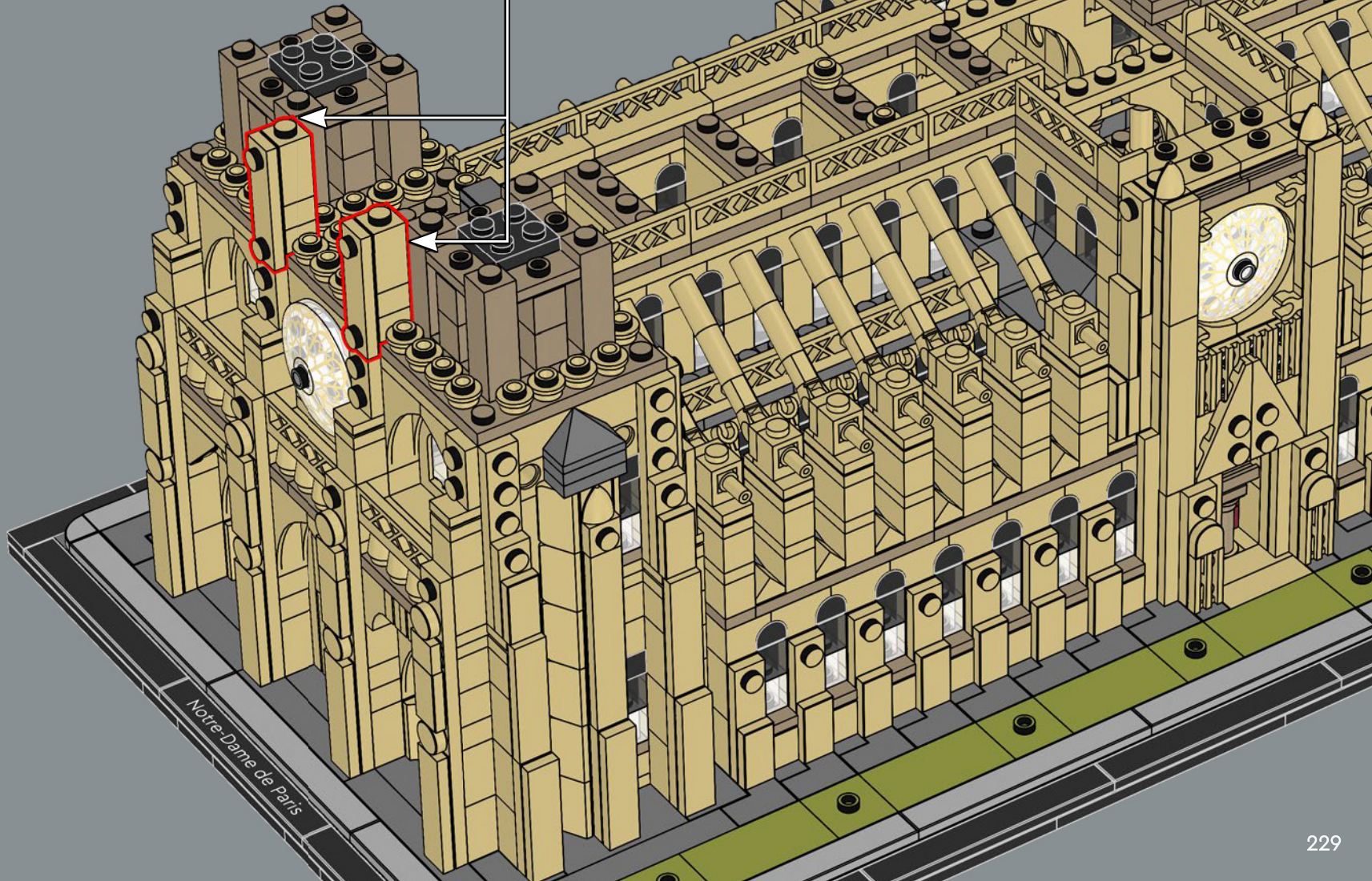
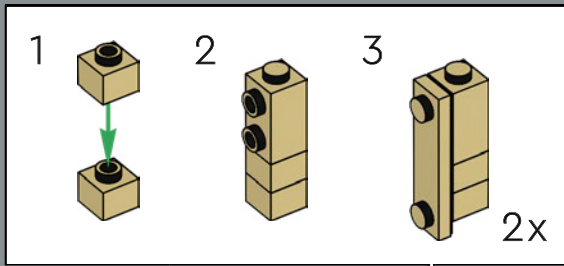



285

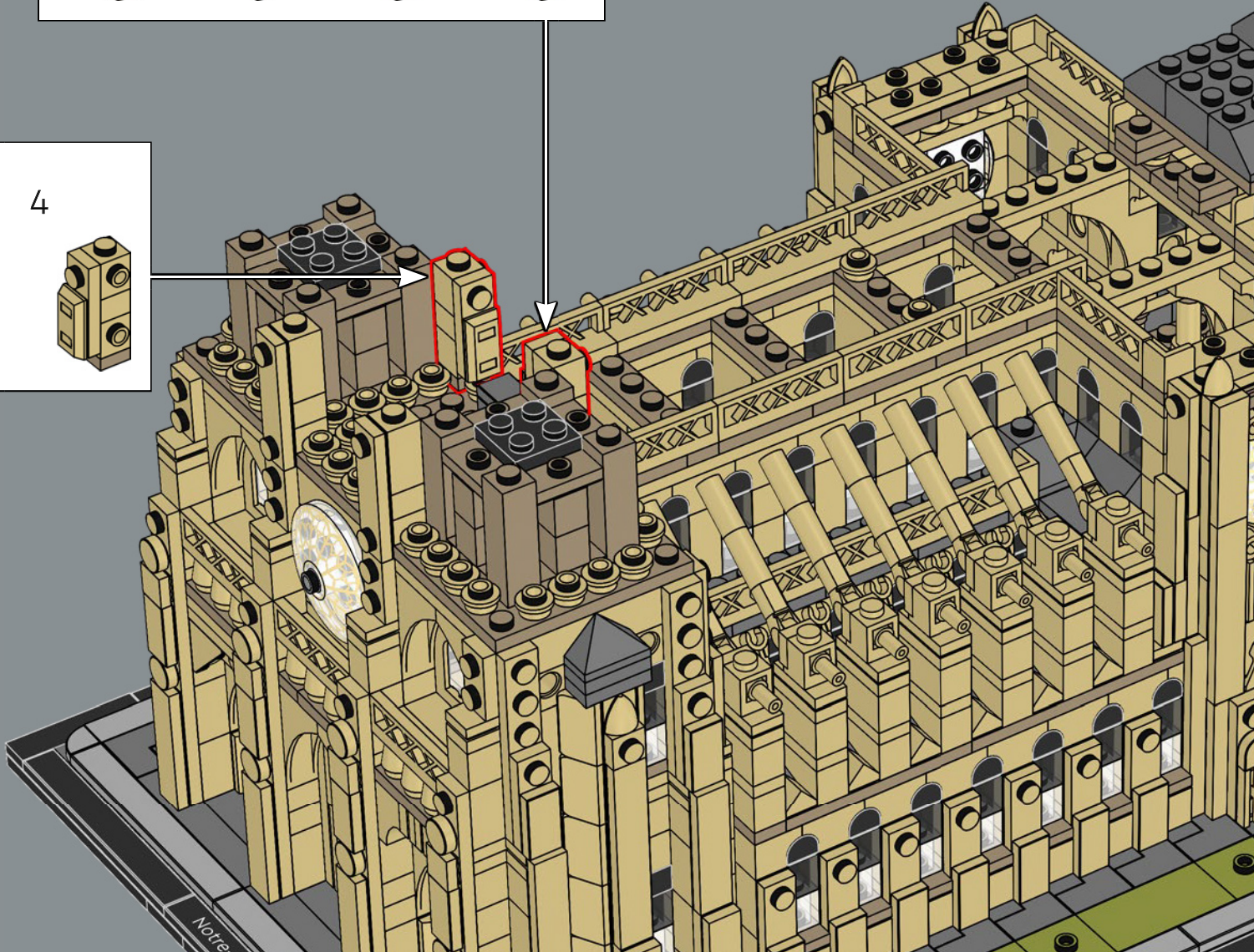
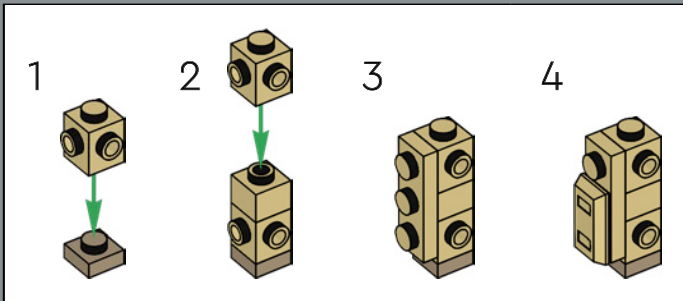
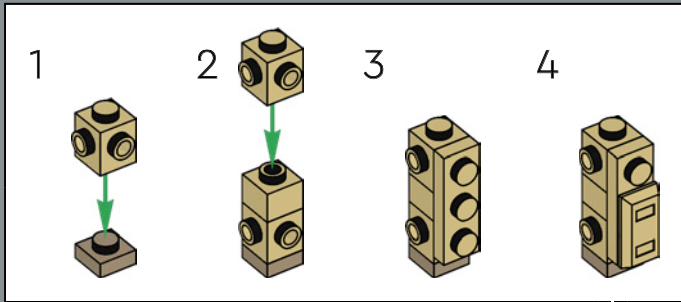

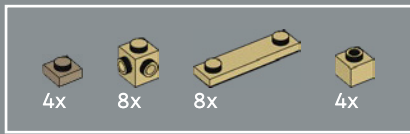

286

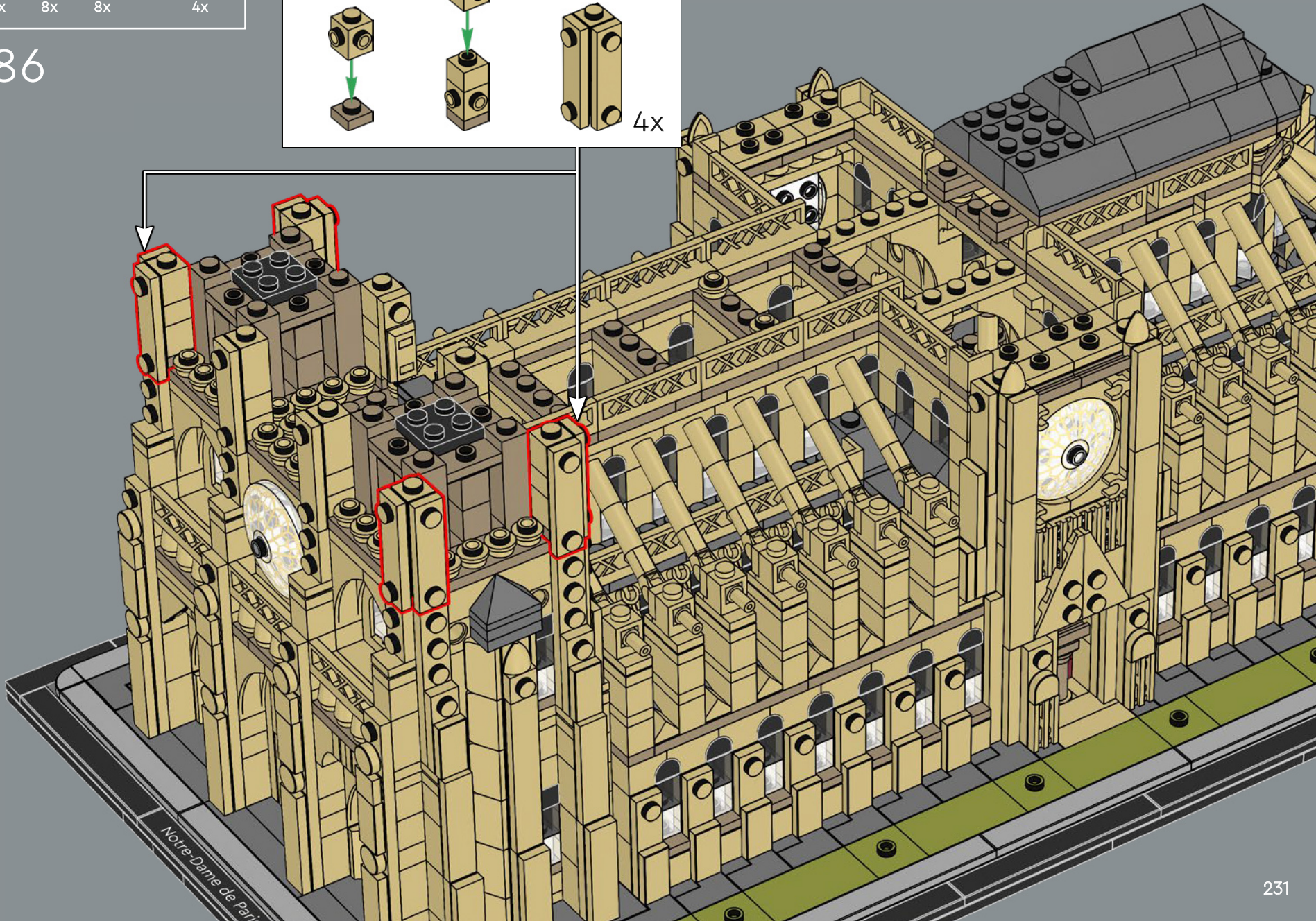
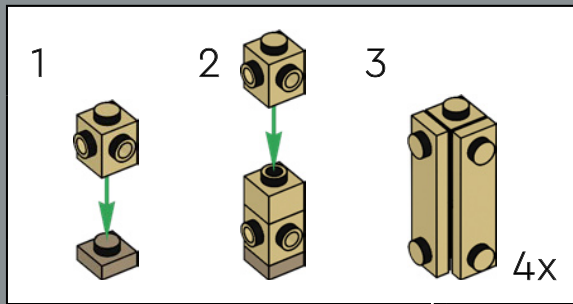

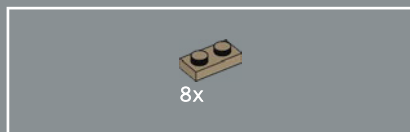

287

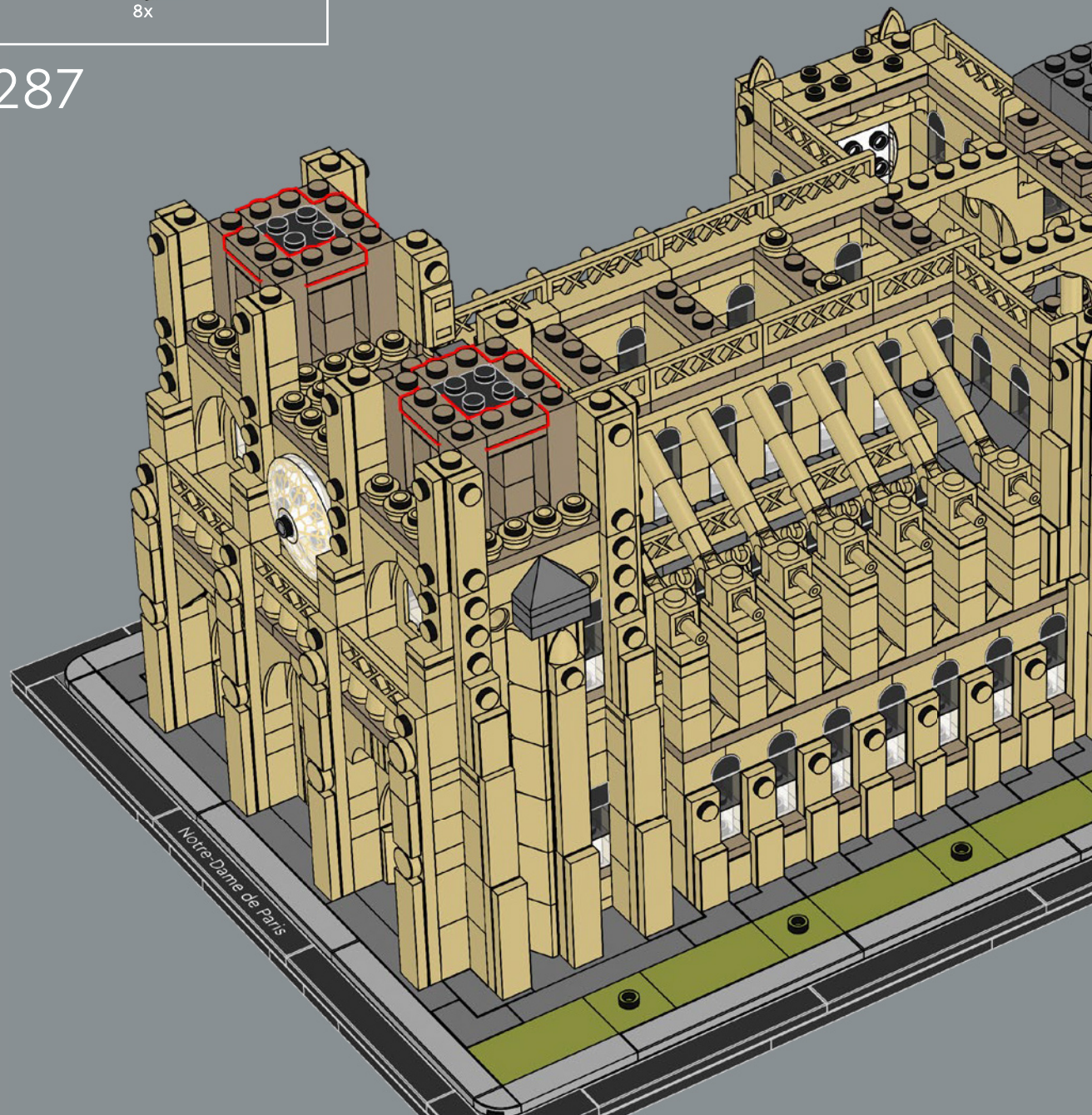



40x

288

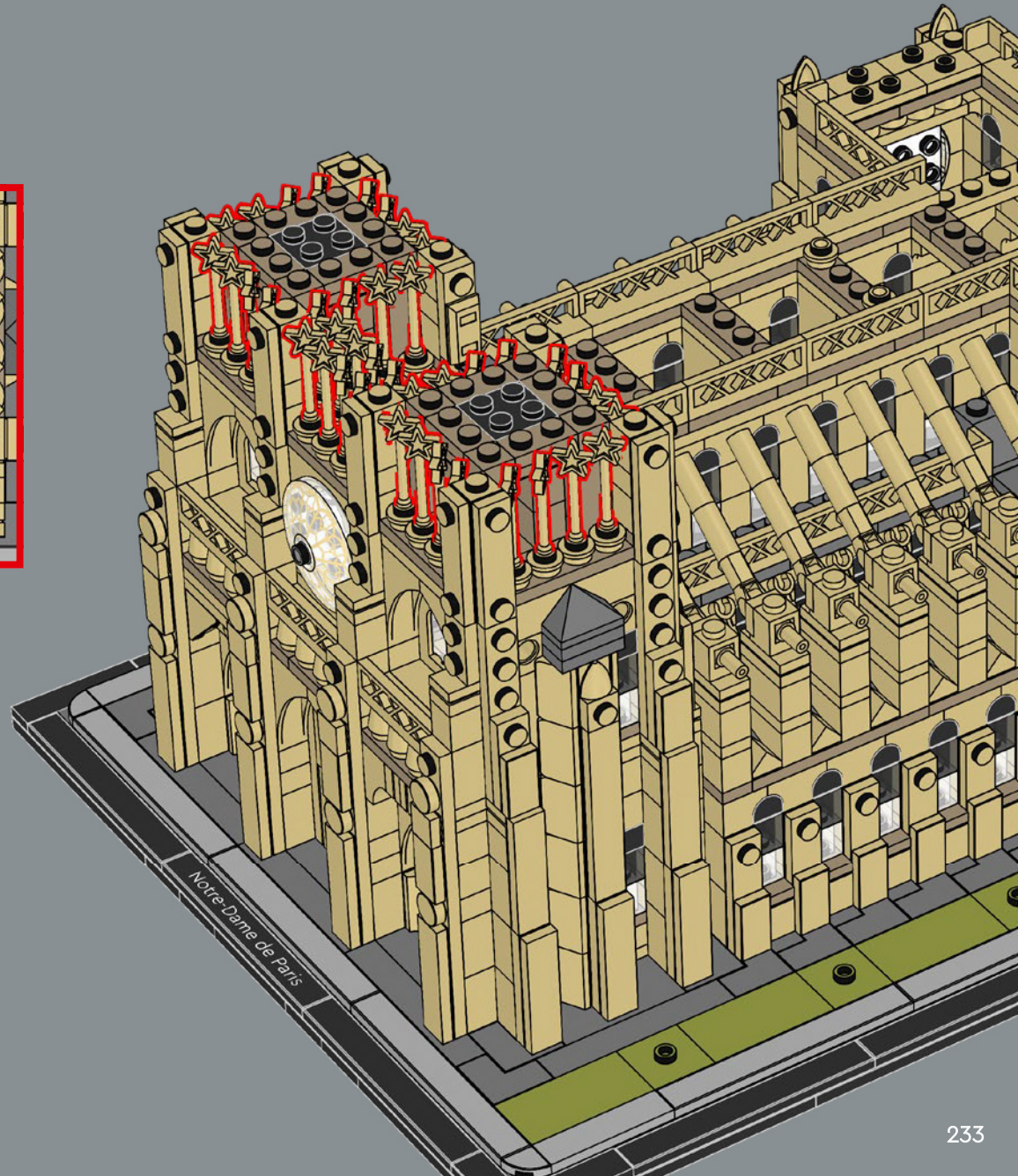
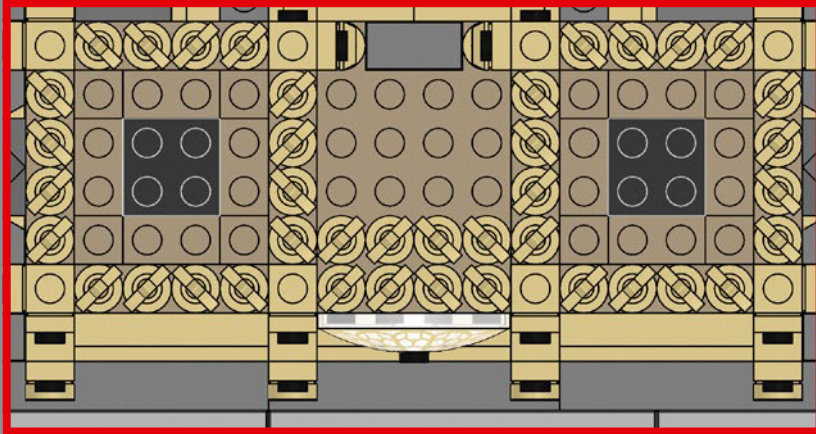

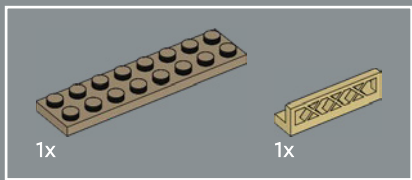

289

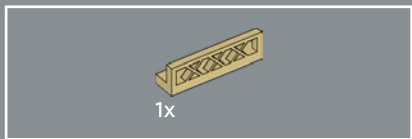
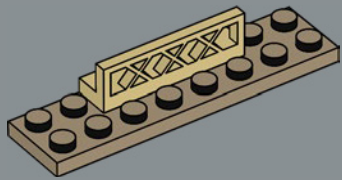

290

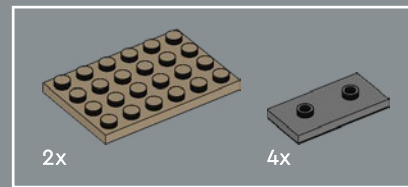
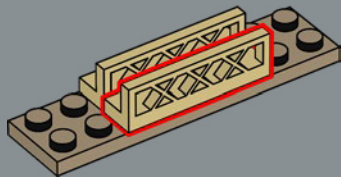

291

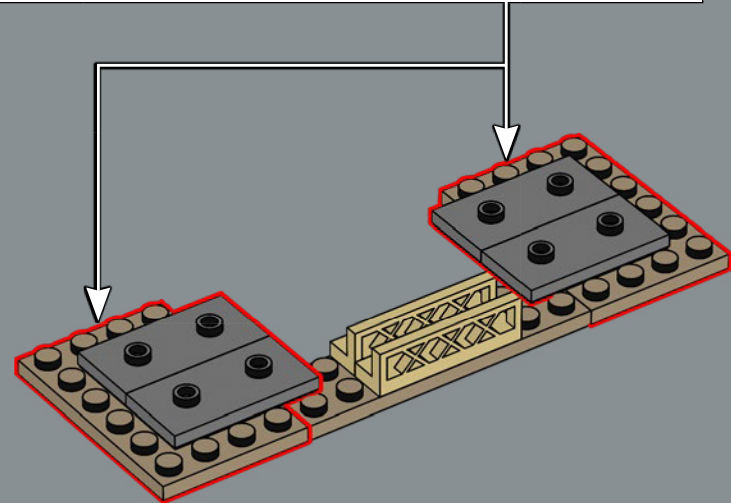
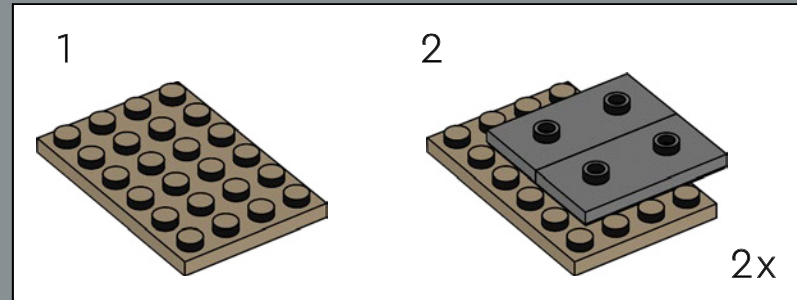

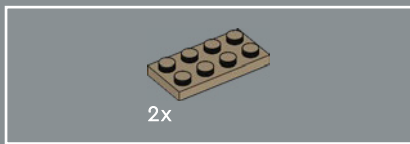

292

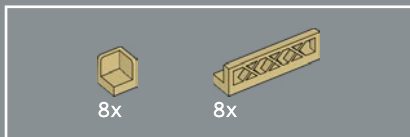
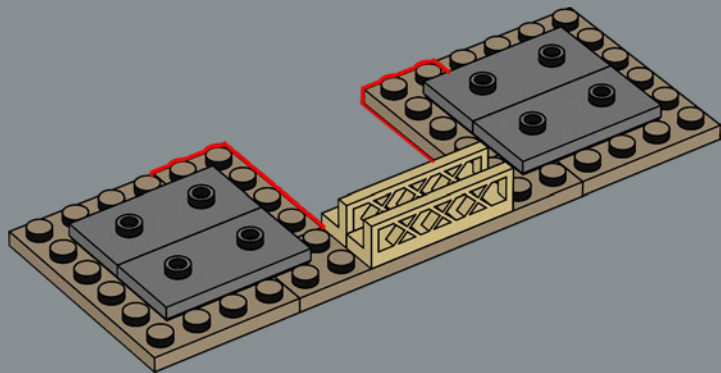

293

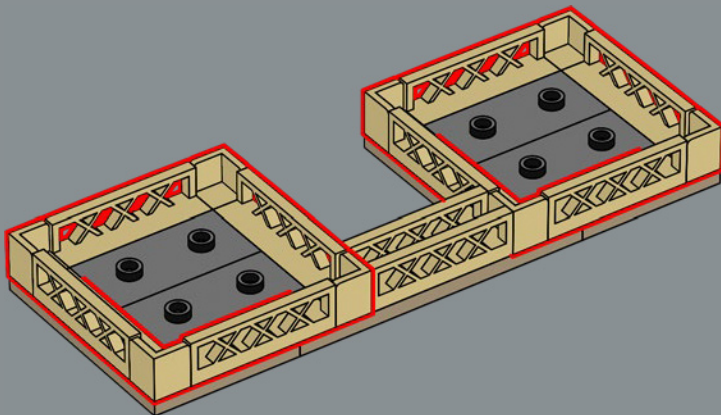

294

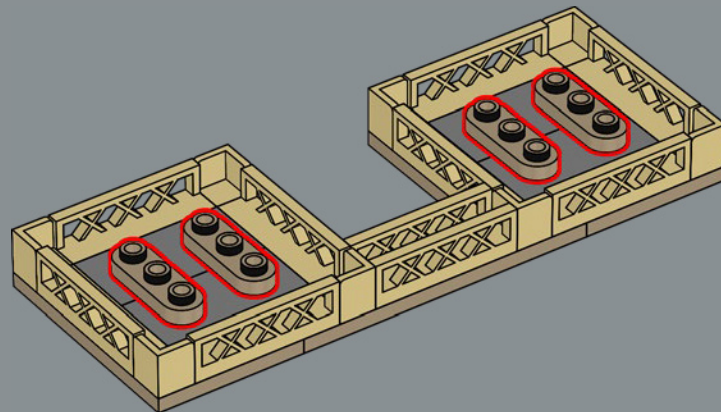

295

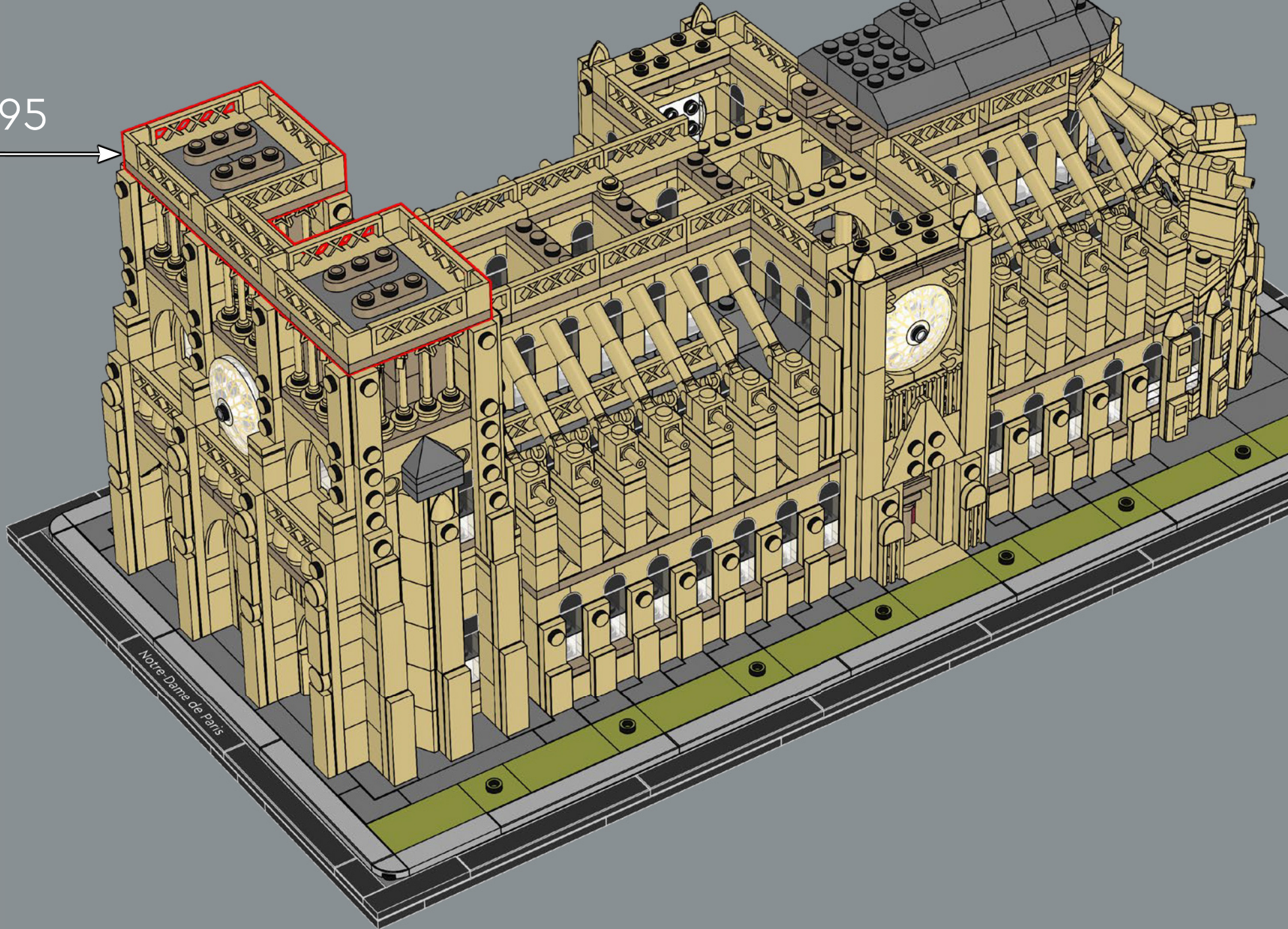

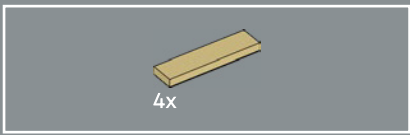

296

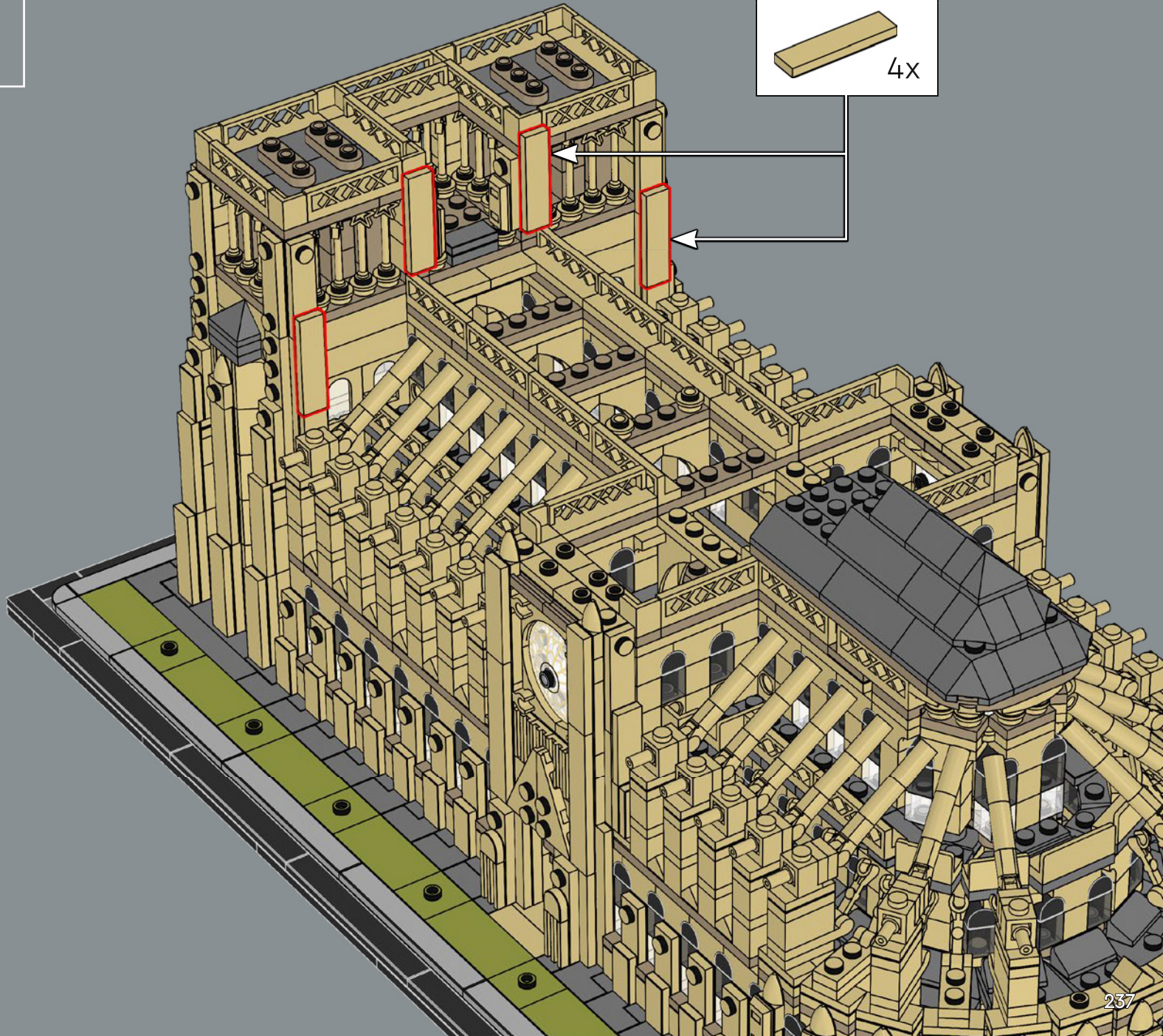
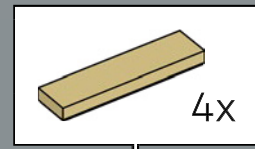



297

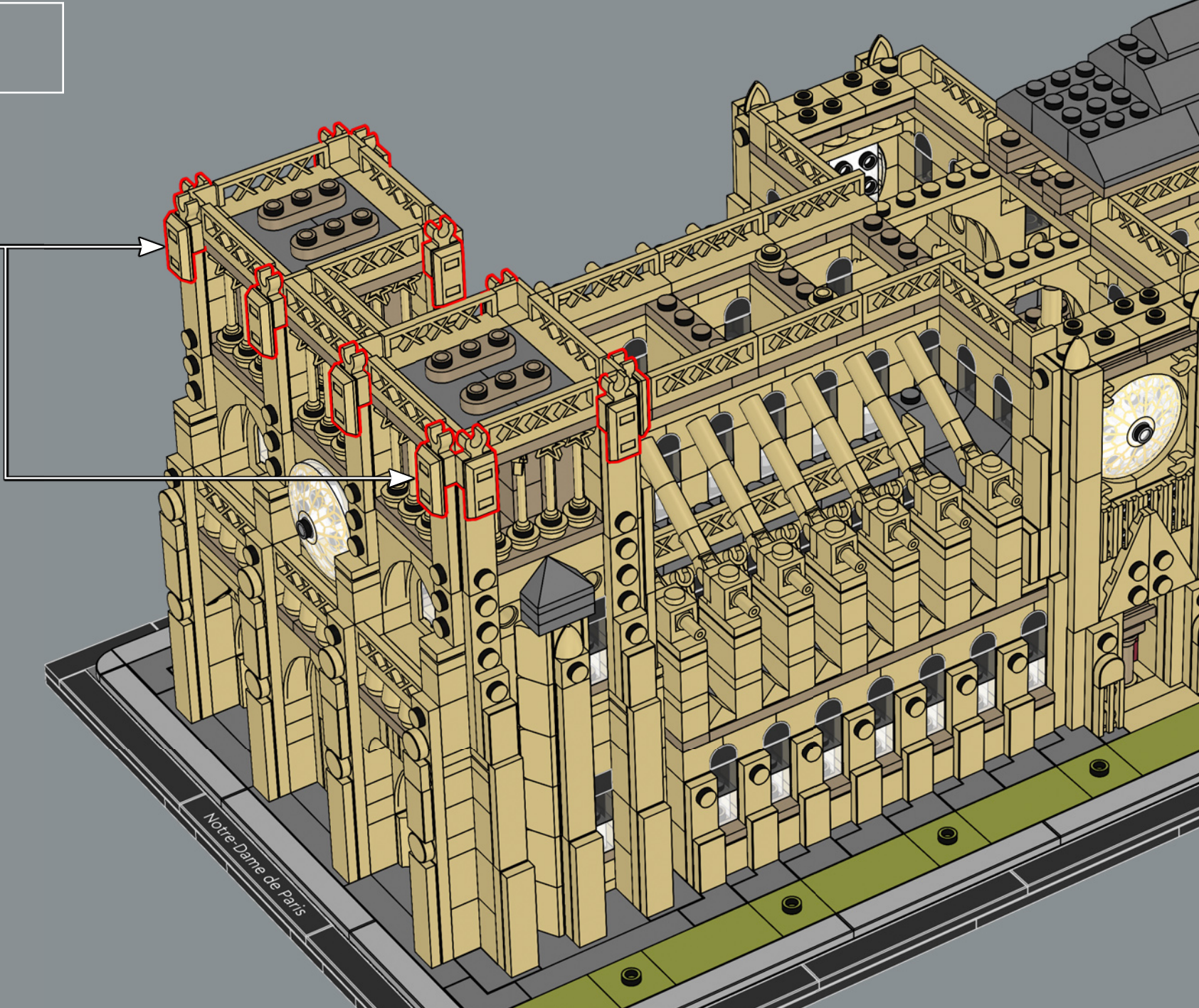
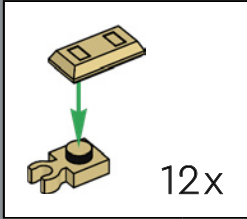

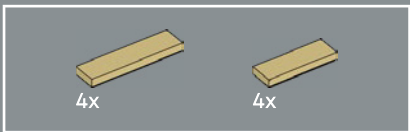

298

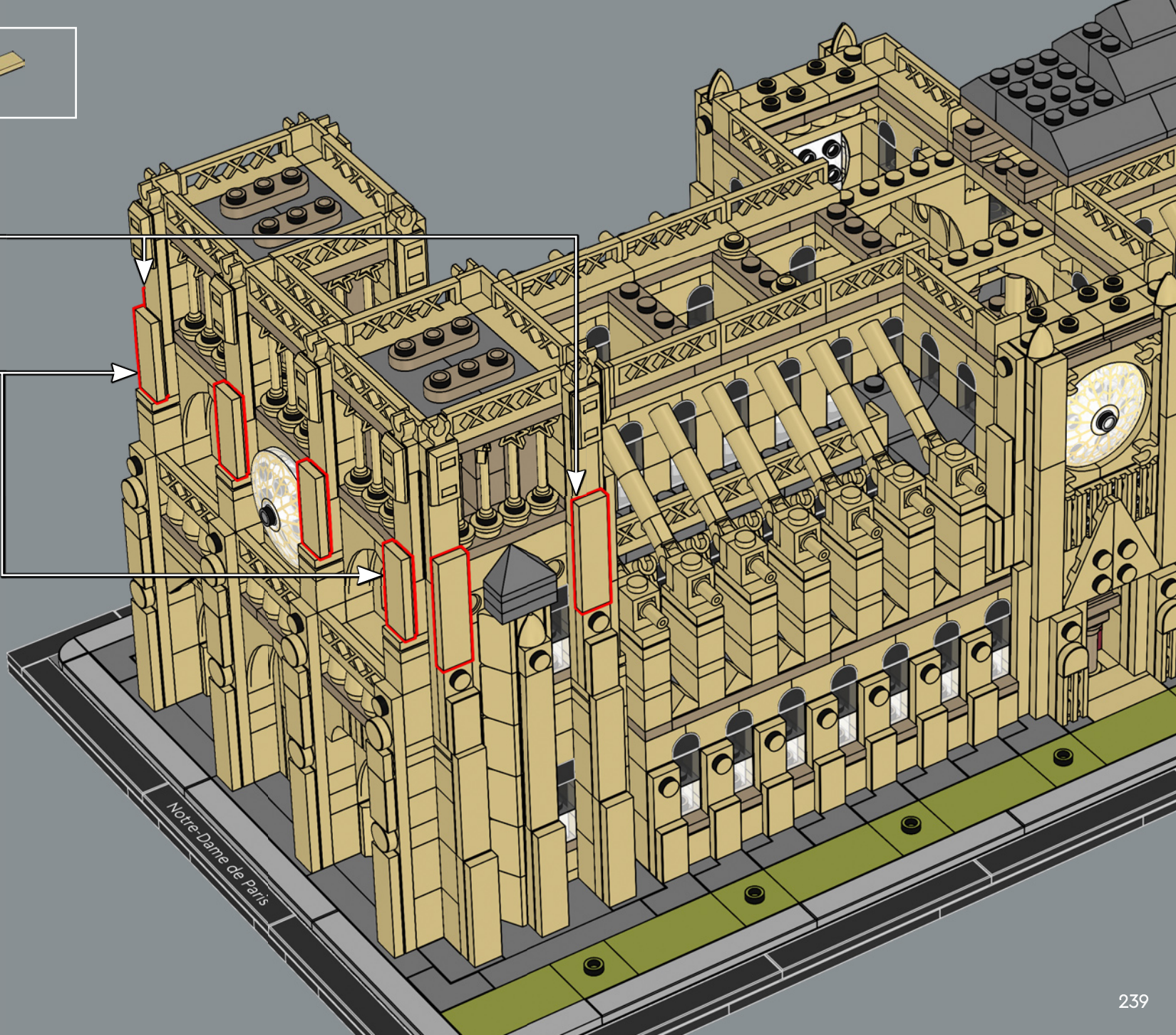
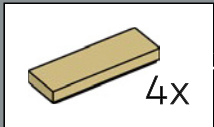
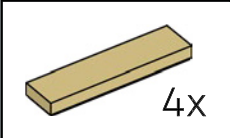



4x

299



4x

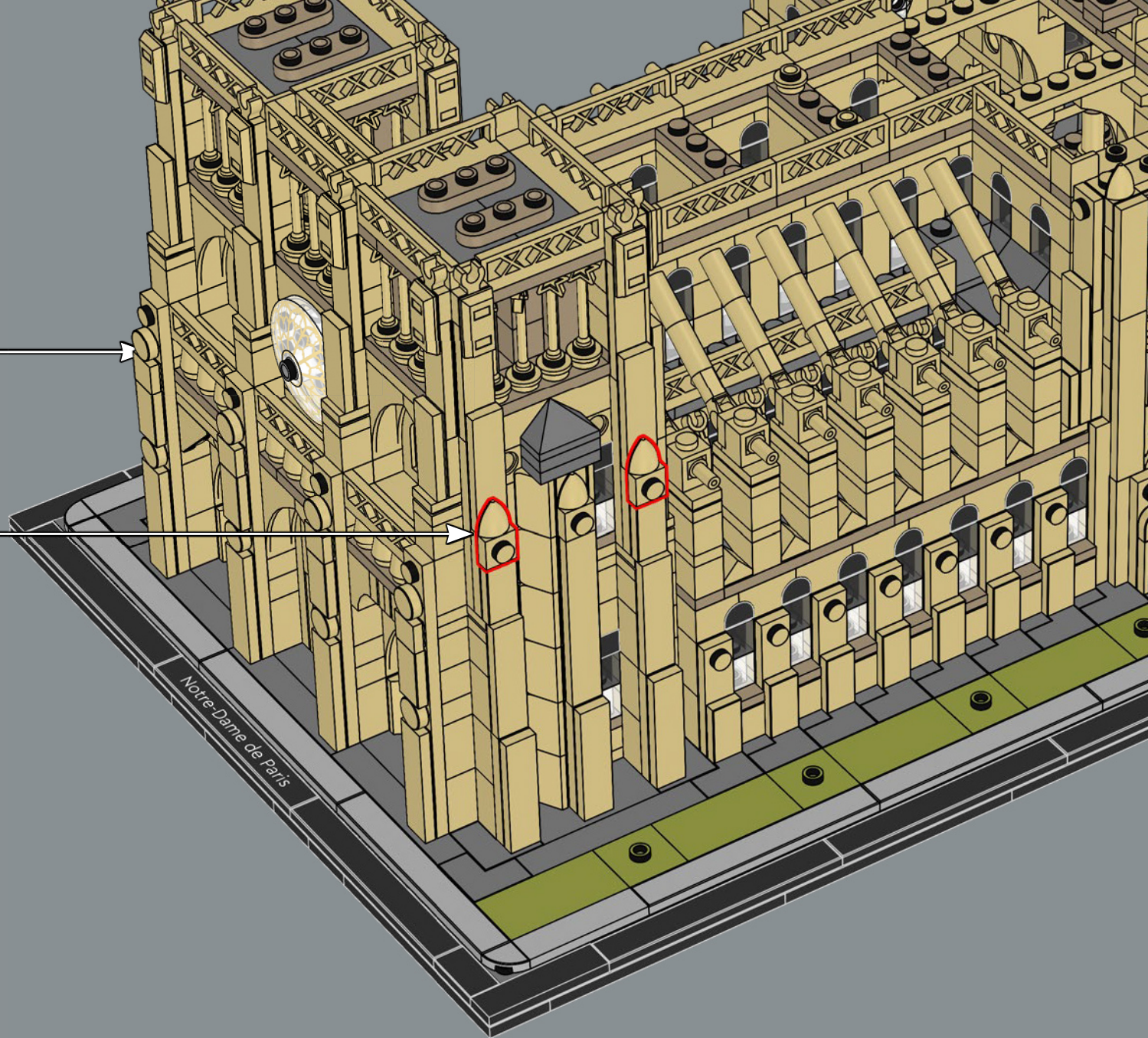

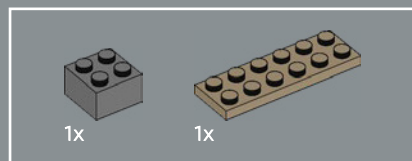
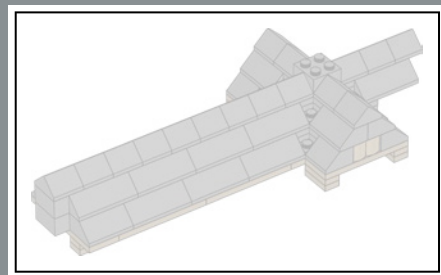

300

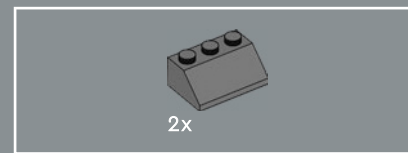
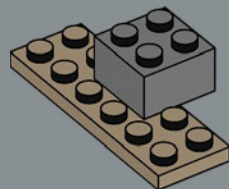

301

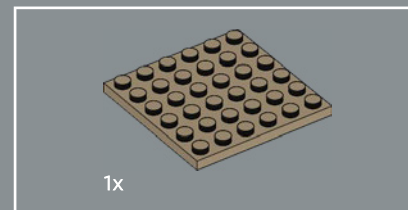
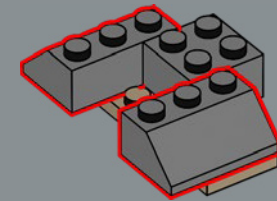

302

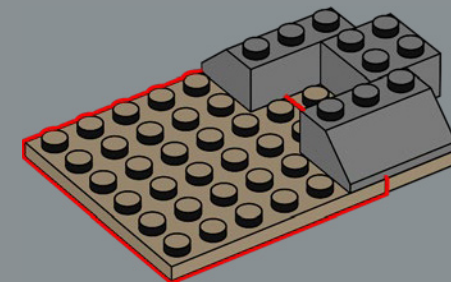

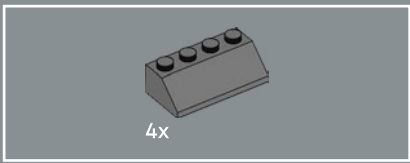

303

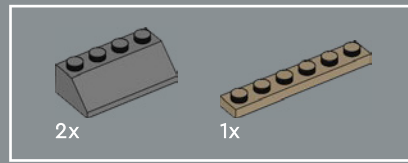
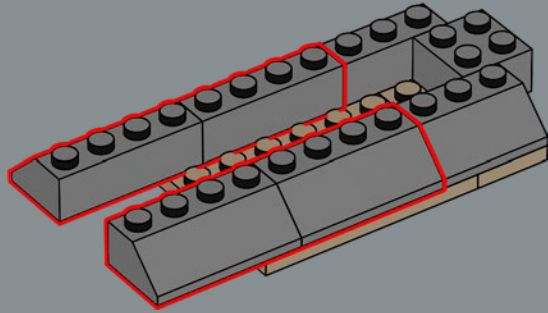

305

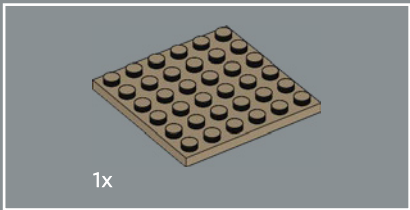
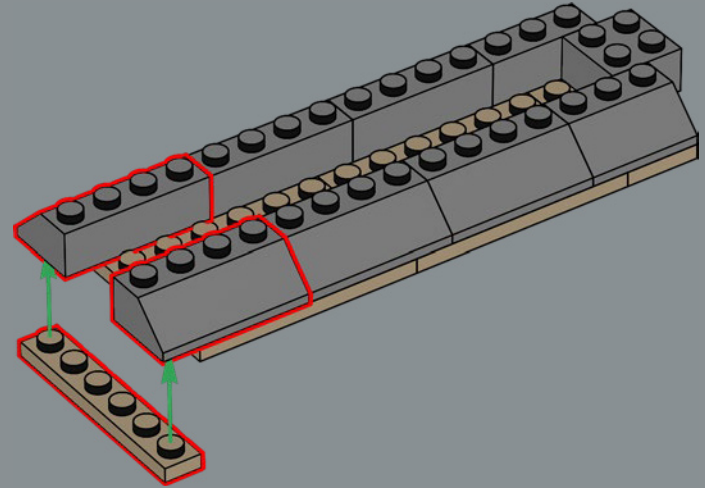

304

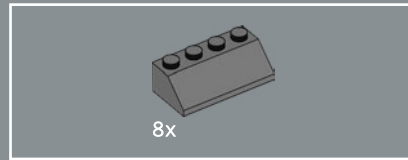
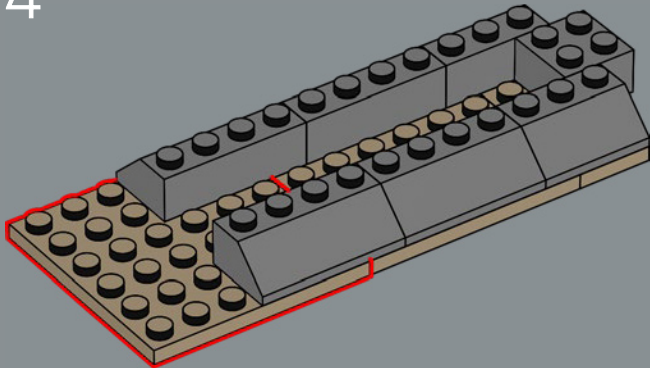

306

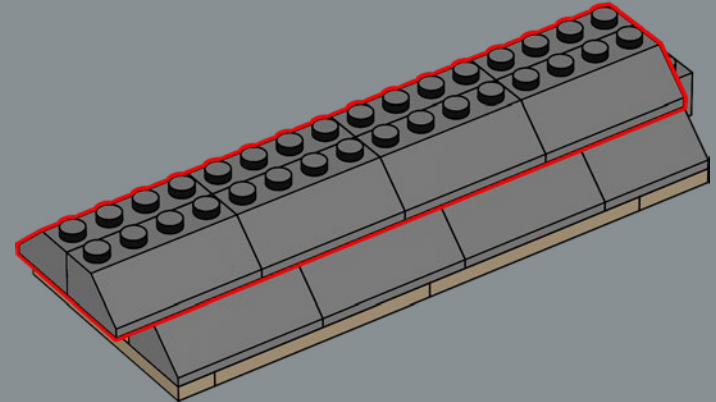

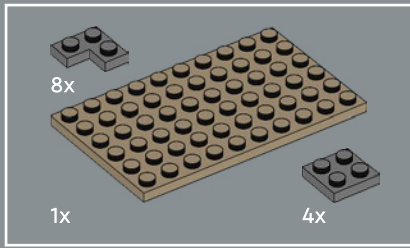

307

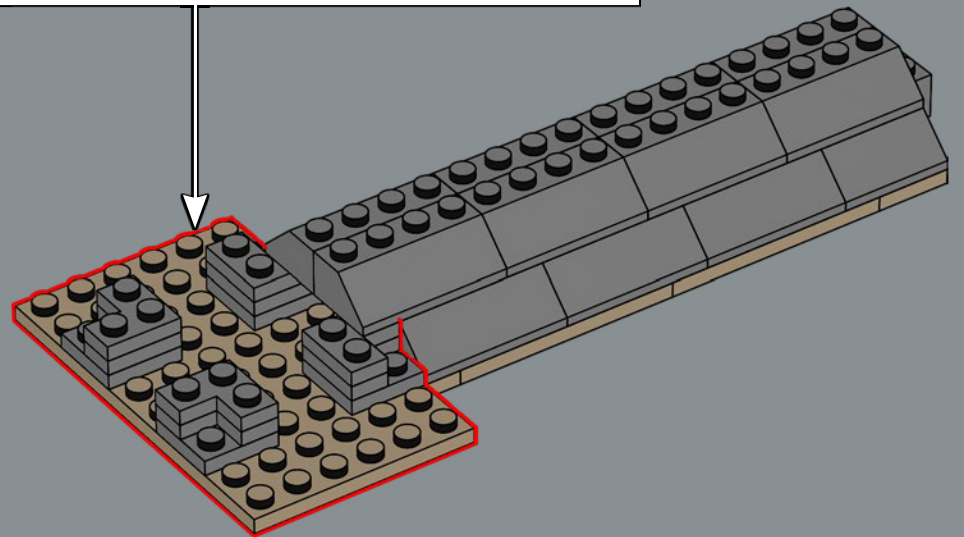
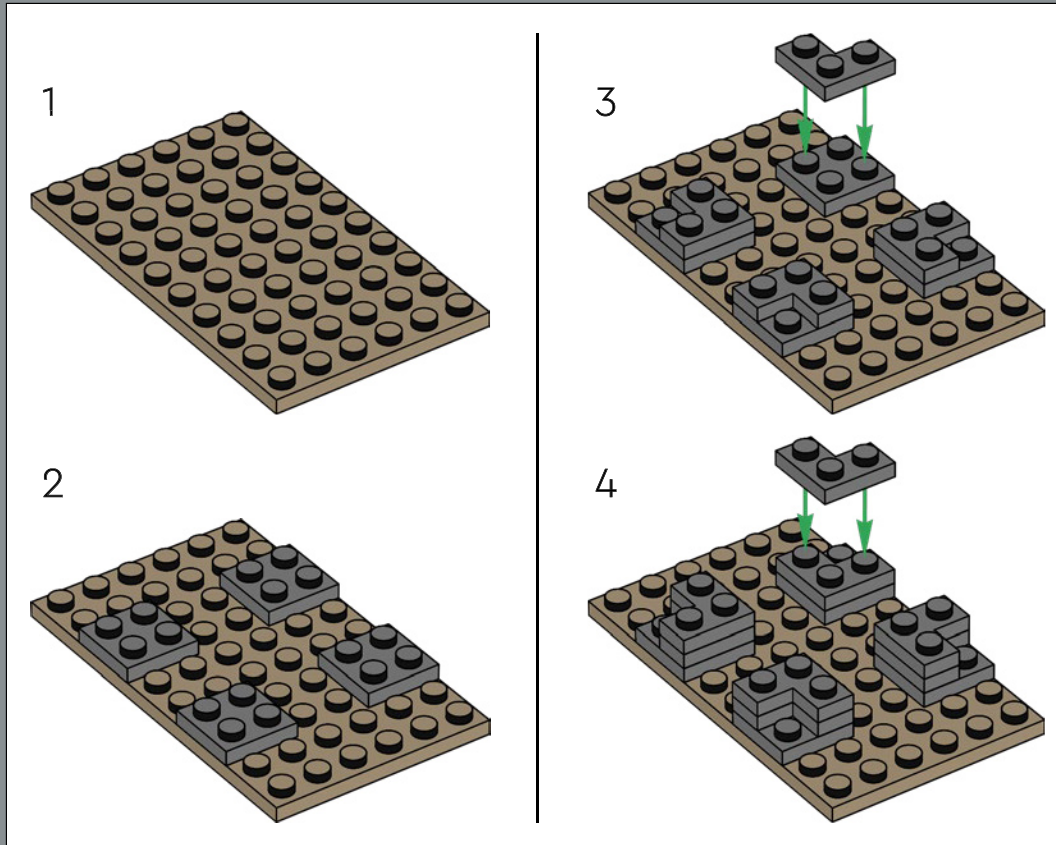

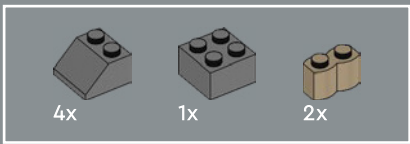

308

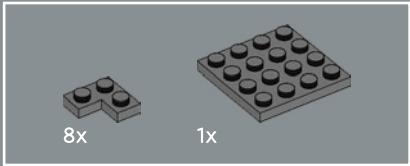
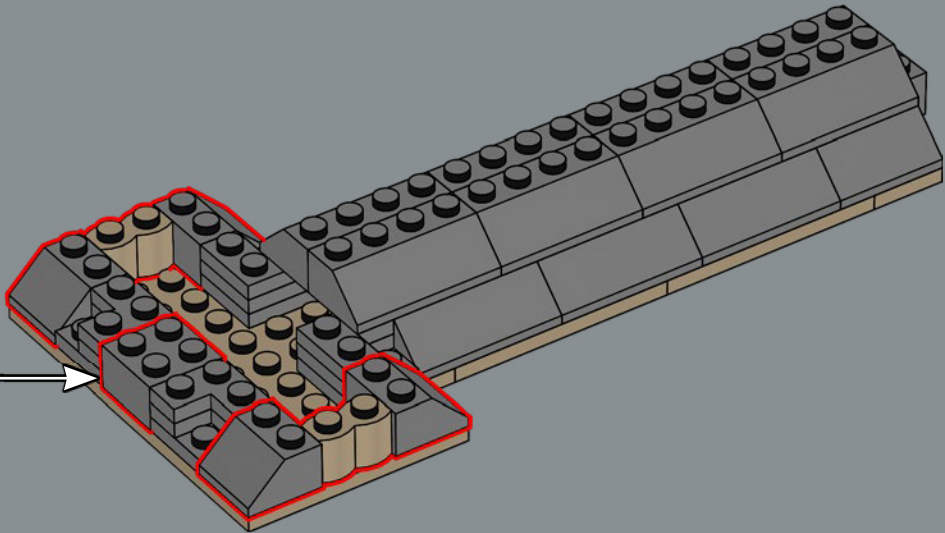
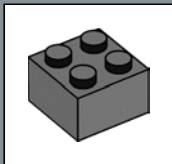

309

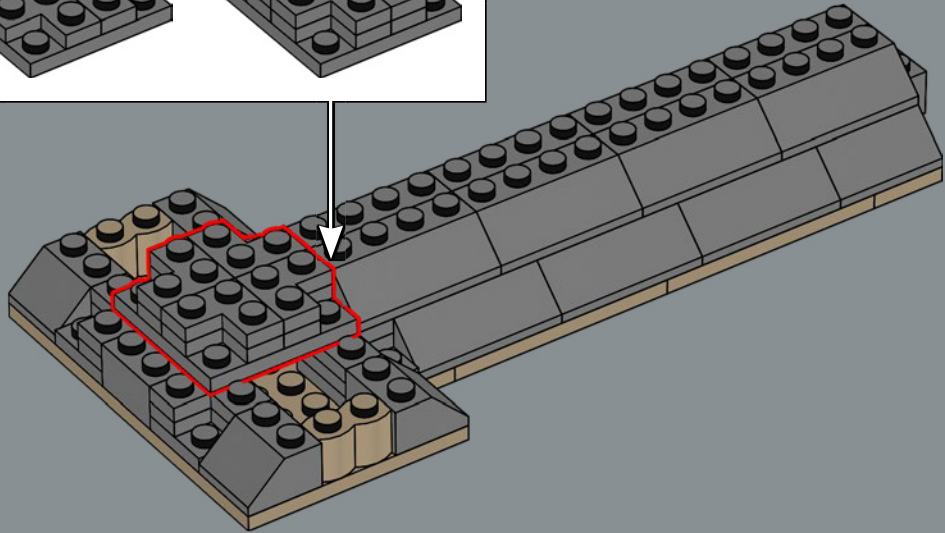
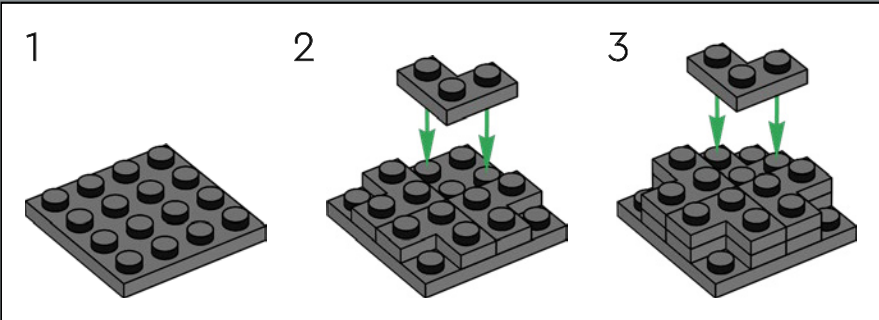

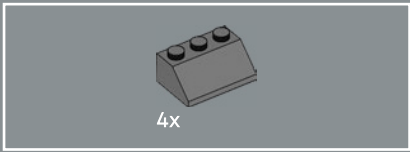

310

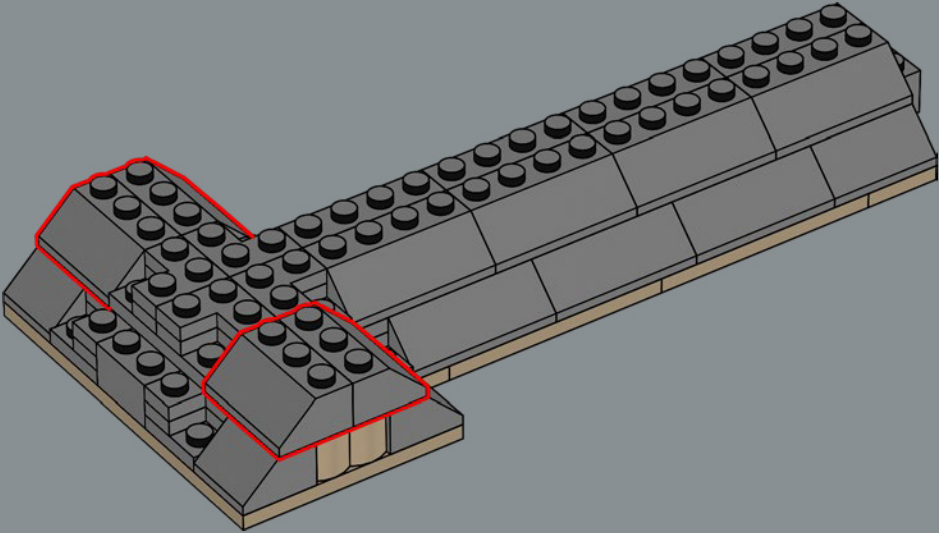

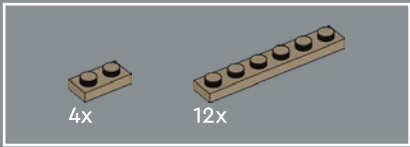

311

1

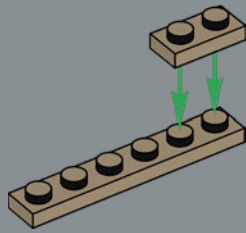

2

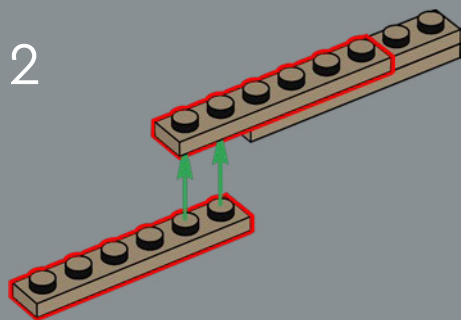

3

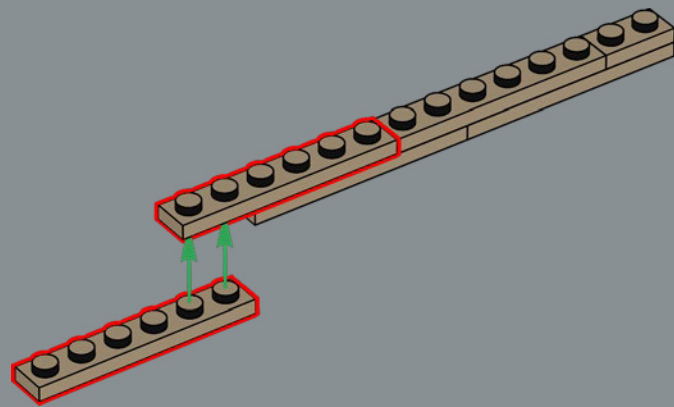

4

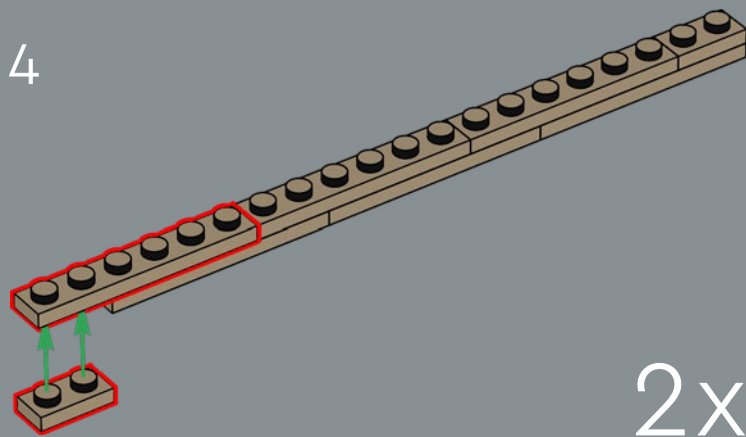

2x

La madera usada para el entramado de la catedral proviene de unos 1300 robles, lo que equivale aproximadamente a 21 hectáreas de bosque.

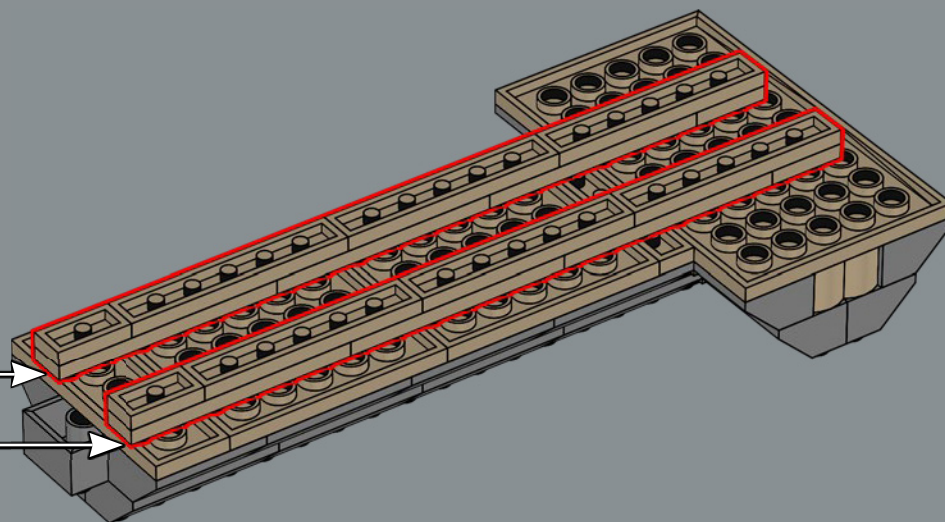



8x

312

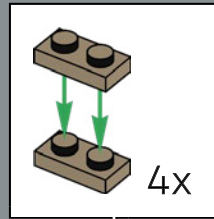

4x

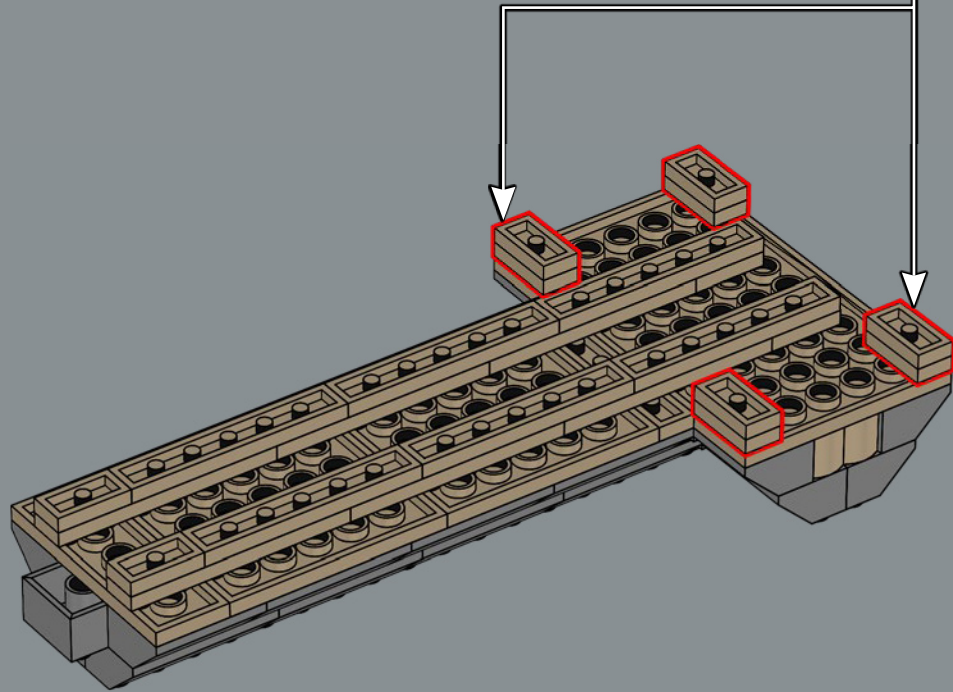

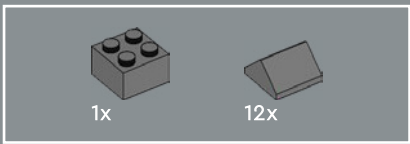

313

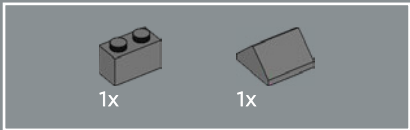
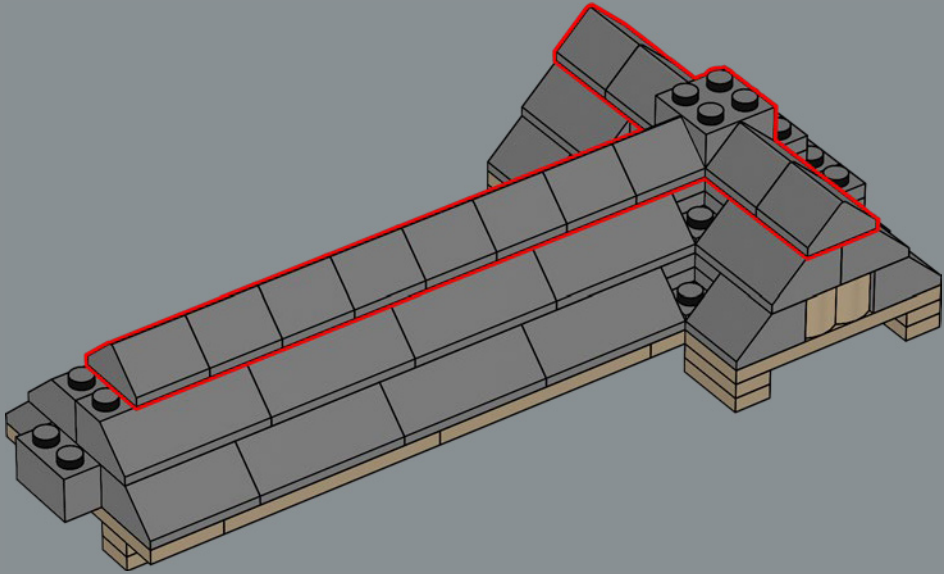

314

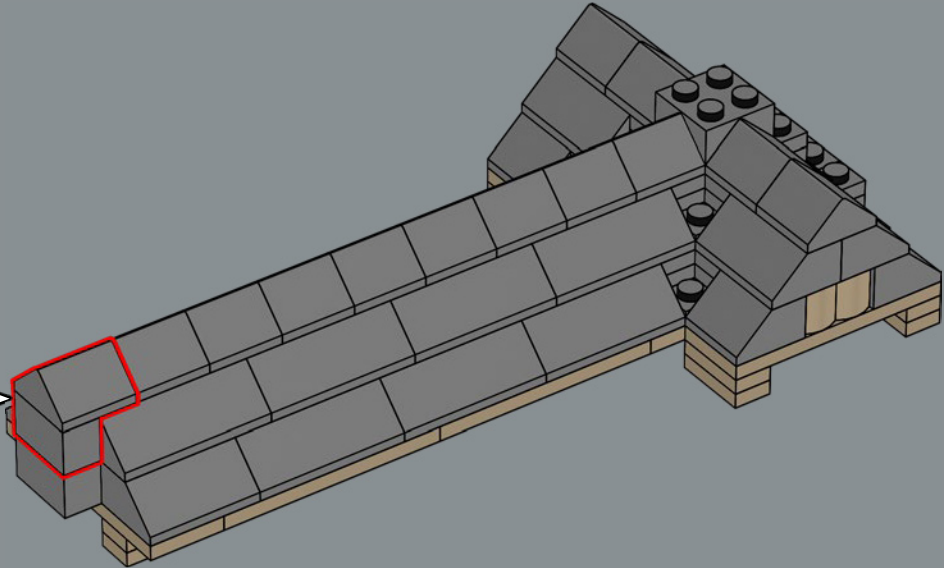
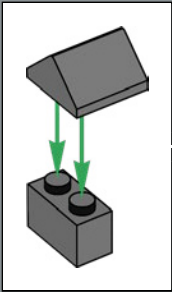

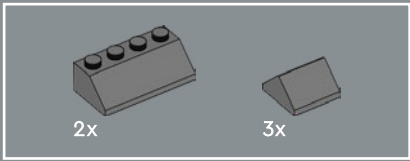

315

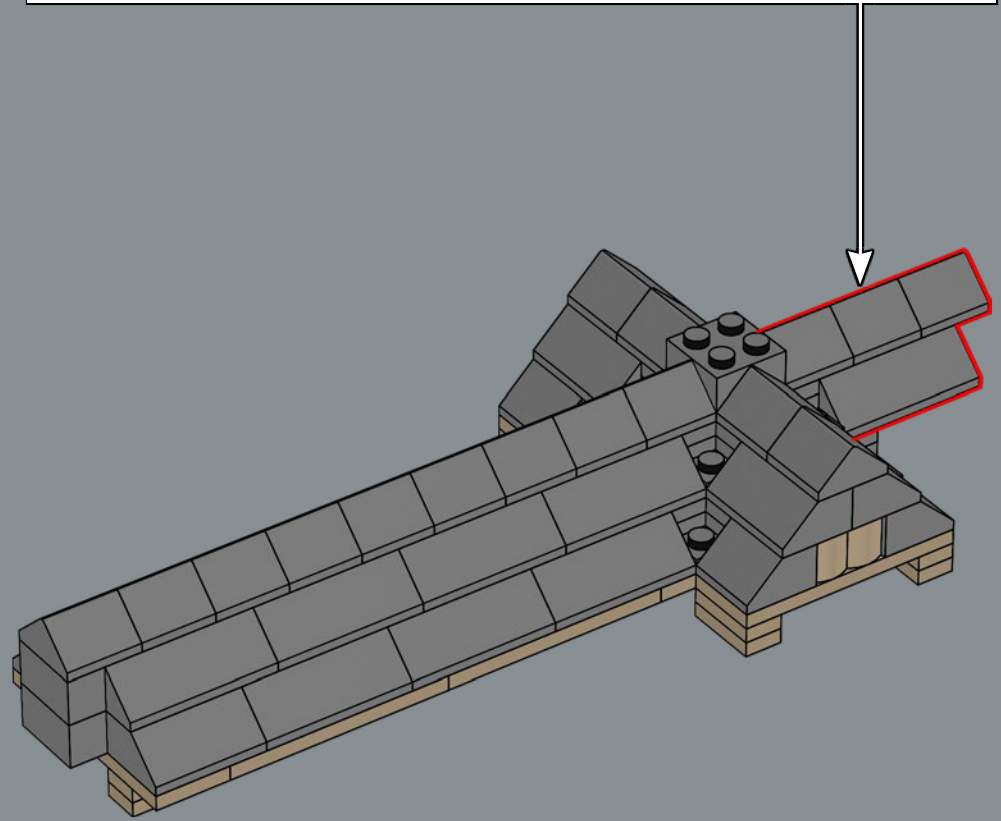
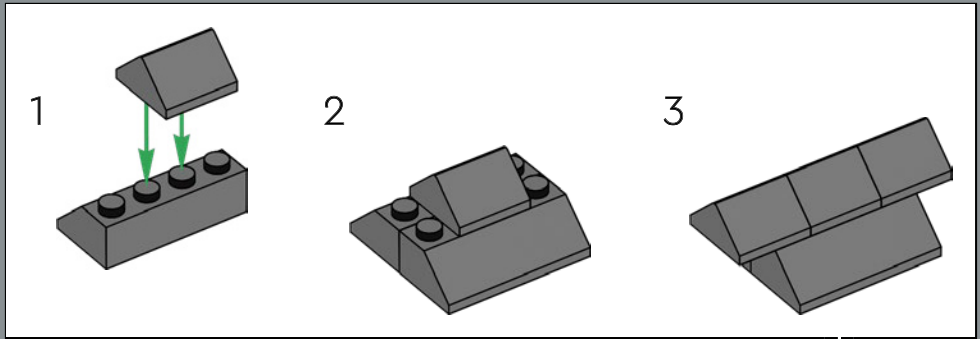

316

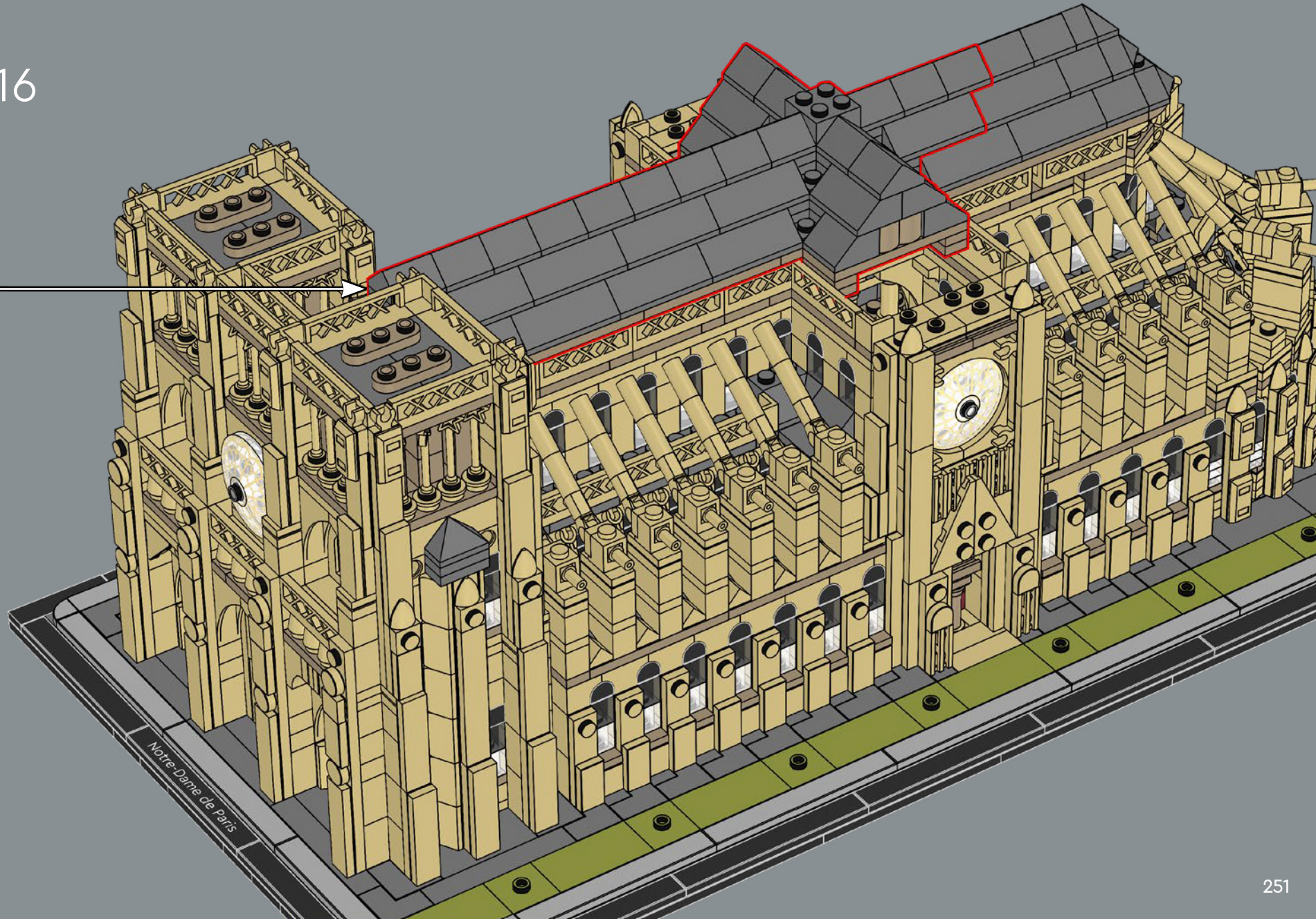

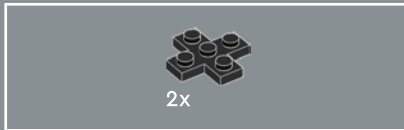
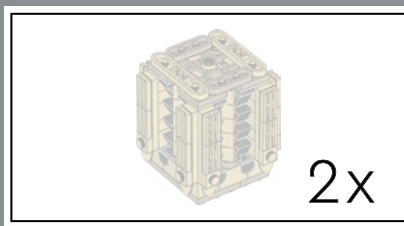

317

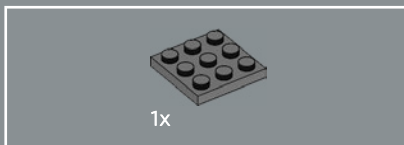
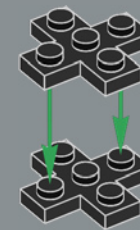

318

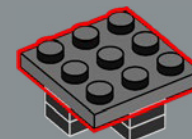

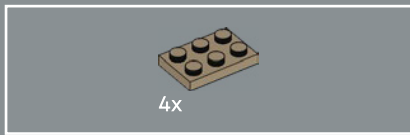

319

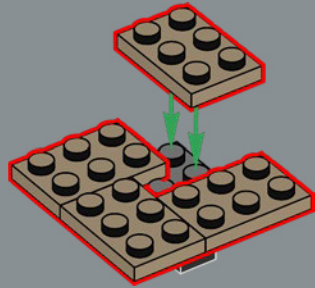

320

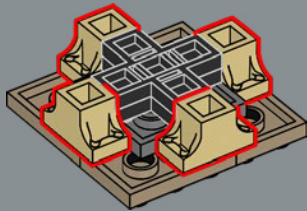

321

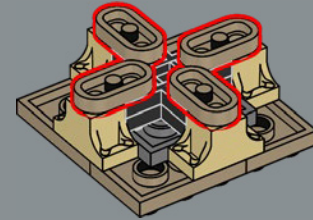

322

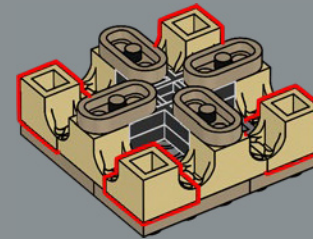



323

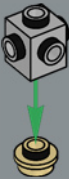

324

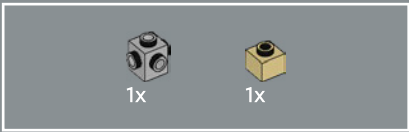

325



326



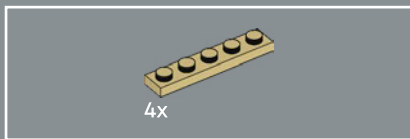

327

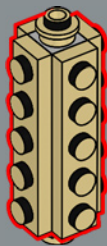

328

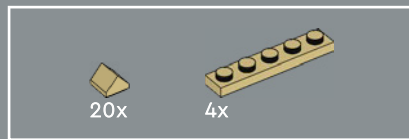
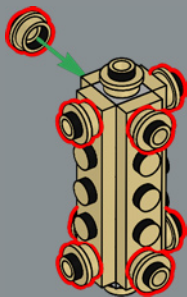

329

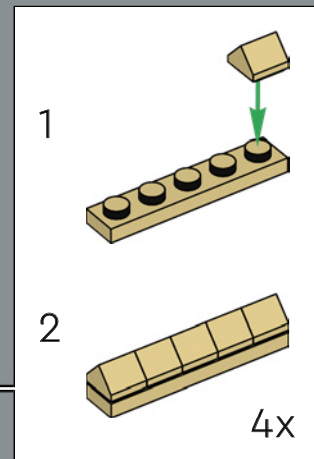
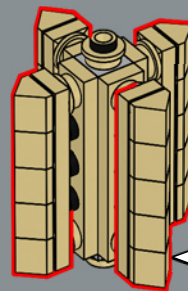

330

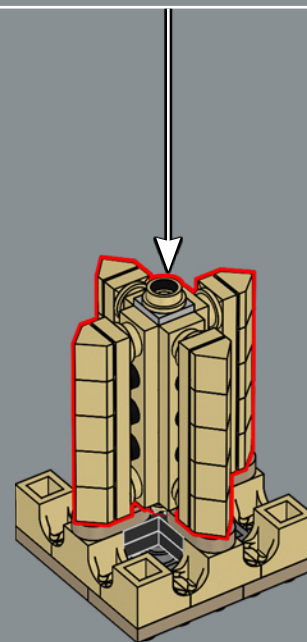

2x



331

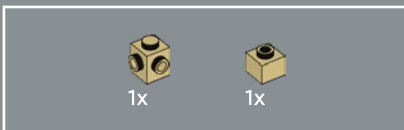

332

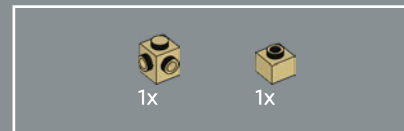
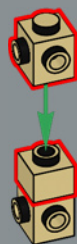

333



337

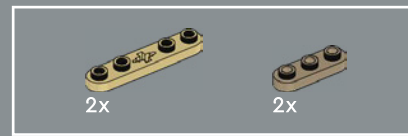
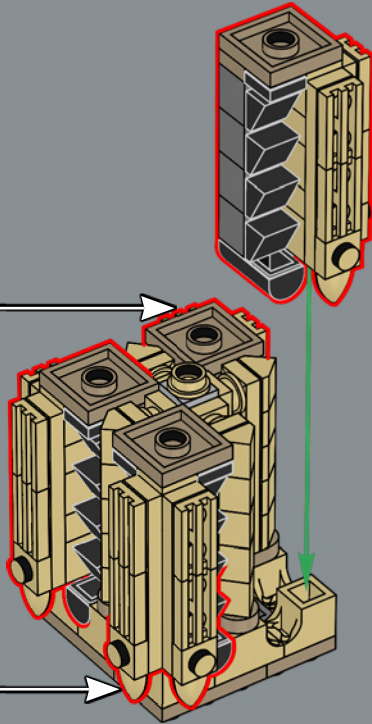

338

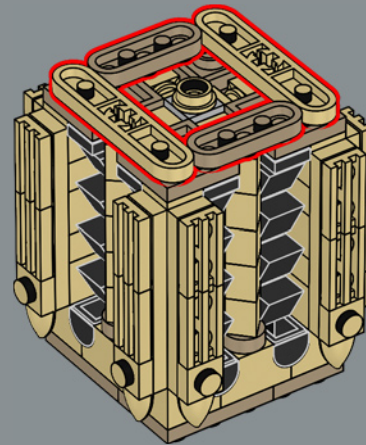

2x

Las torres albergan las legendarias campanas de la catedral.
Primero se instalaron en la torre septentrional, también
conocida como Grosse Tour o Torre Guillaume.

339

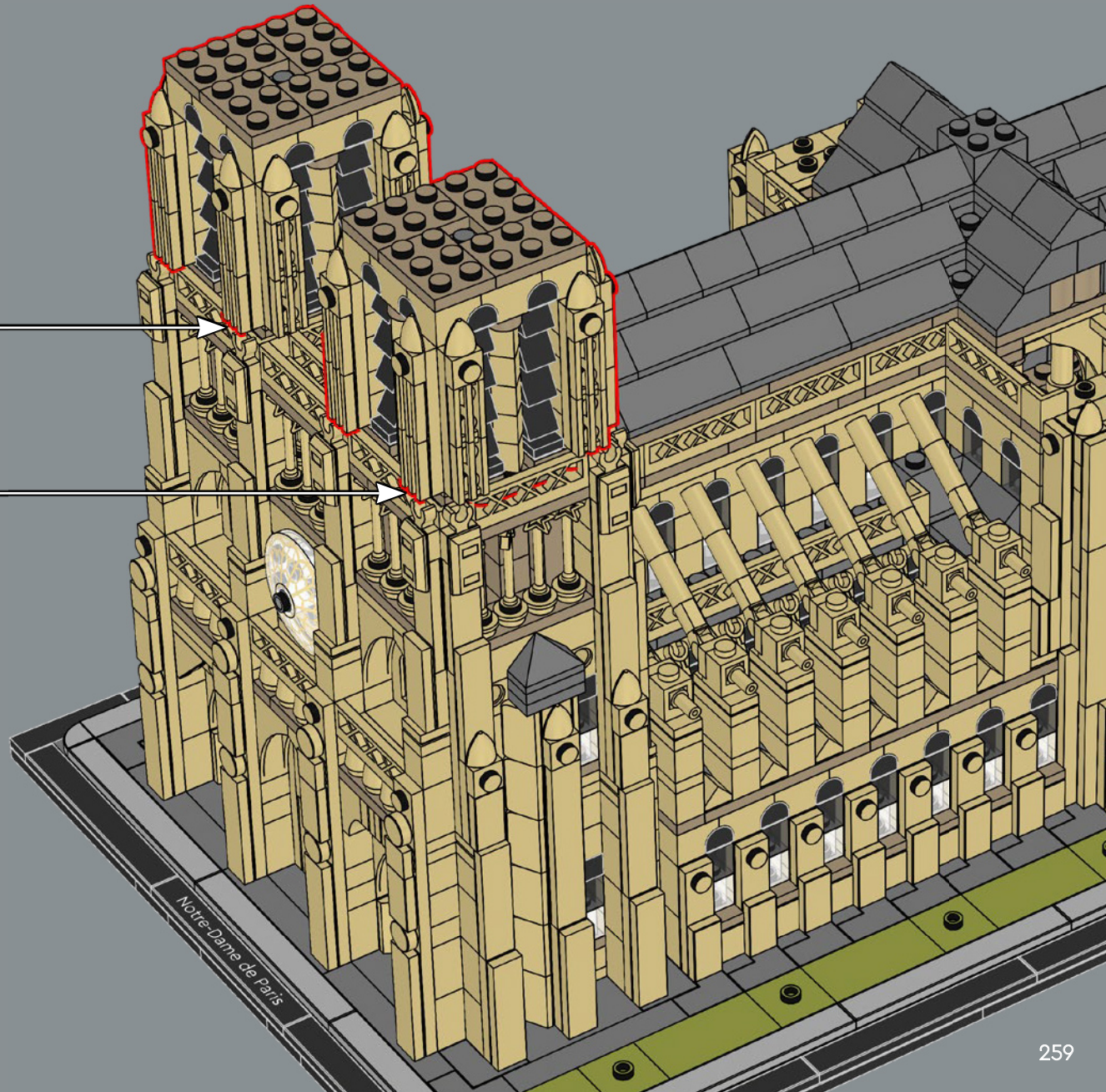



340

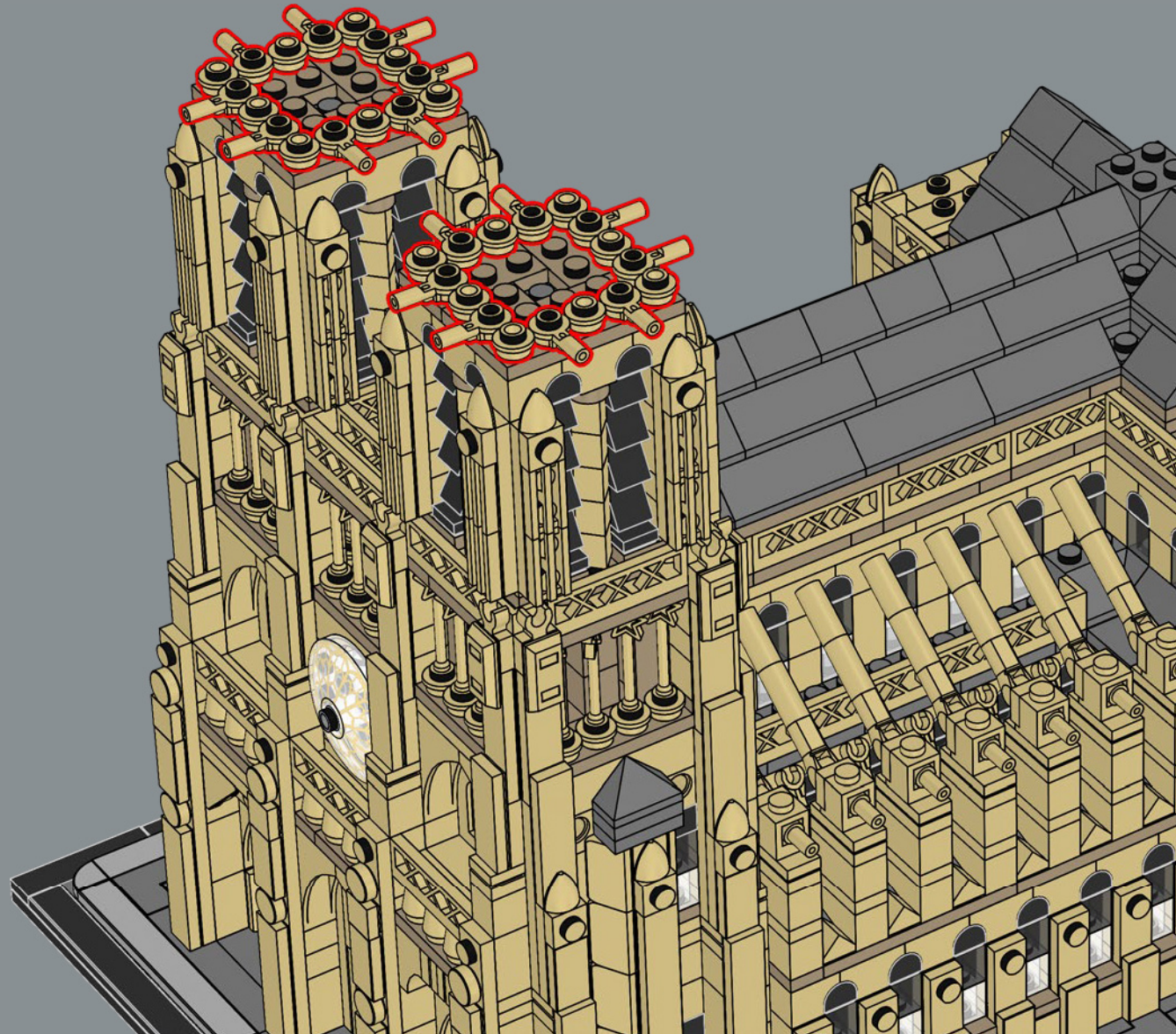

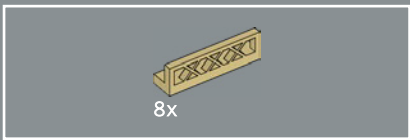

341

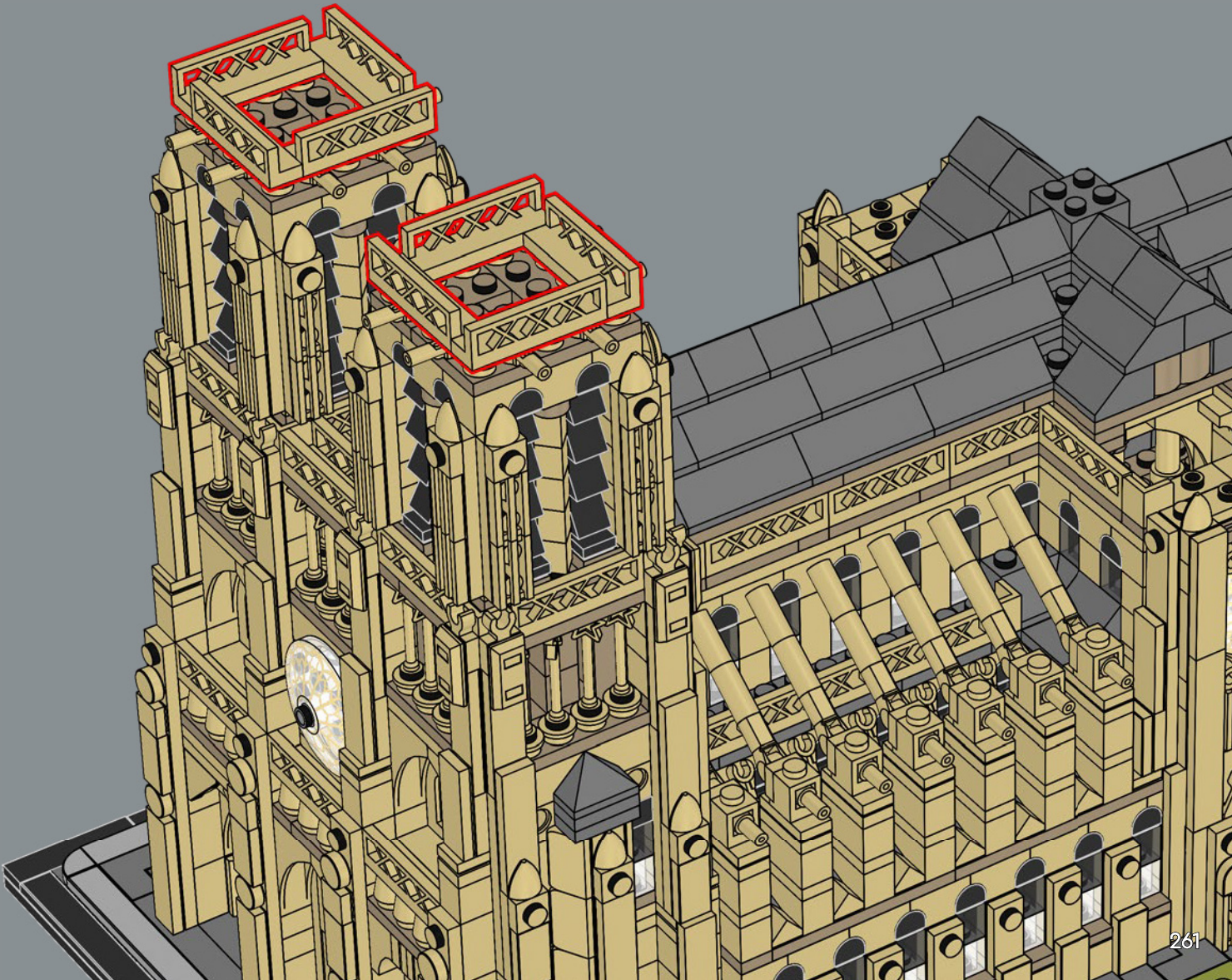

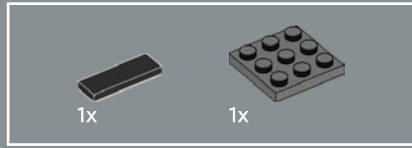
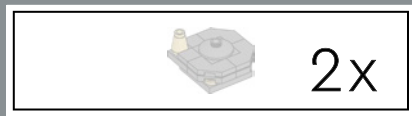

342

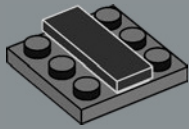

343

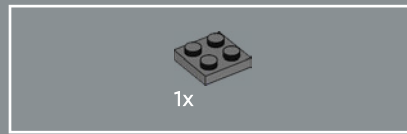
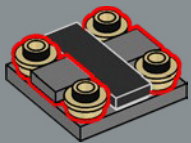

344

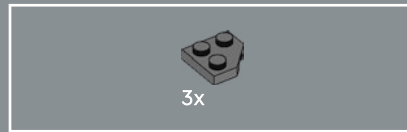
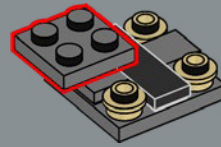

345

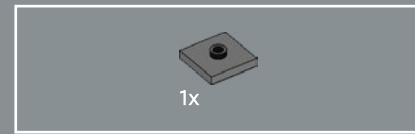
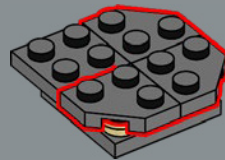

346

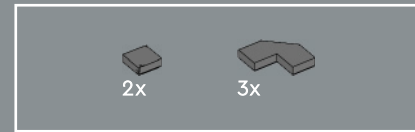
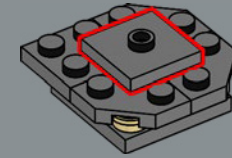

347

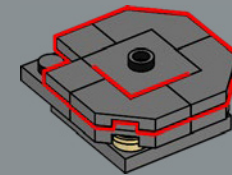



348

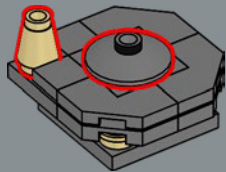

2x

349

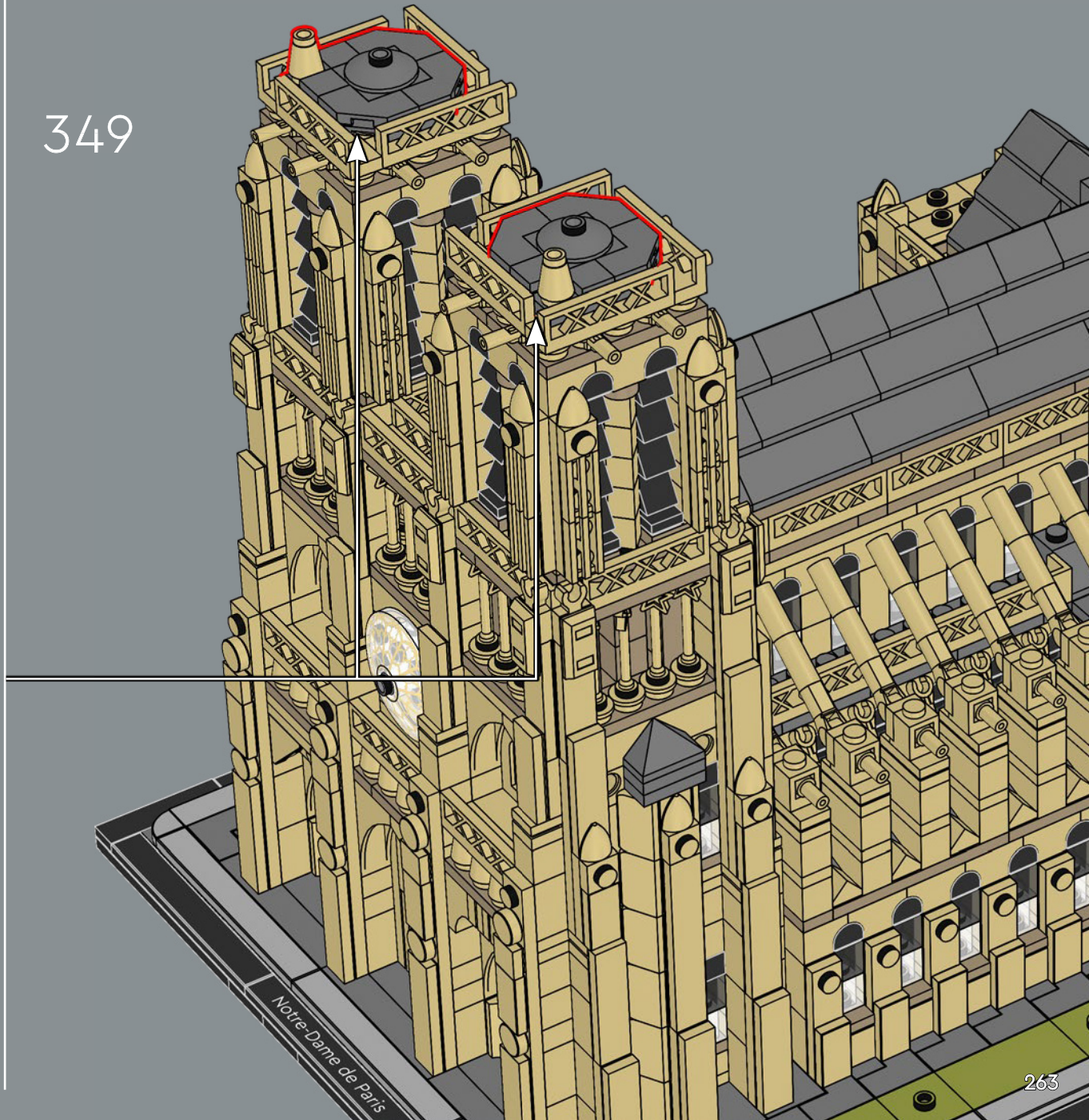

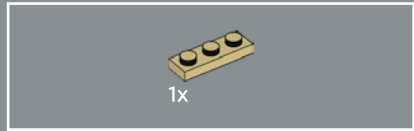
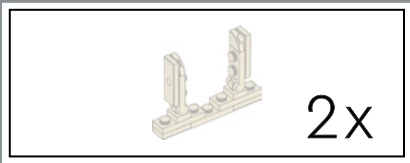

350

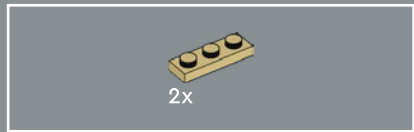
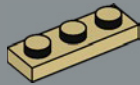

351

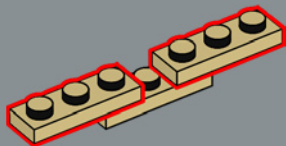

352

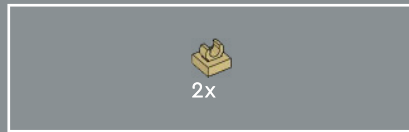
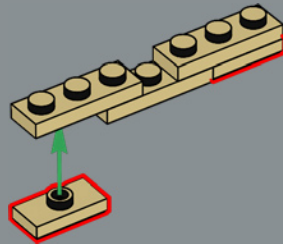

353

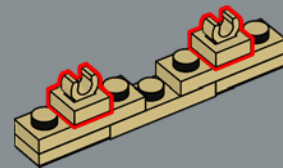

354

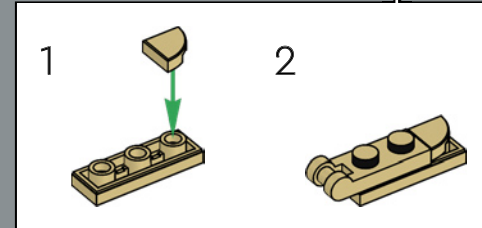
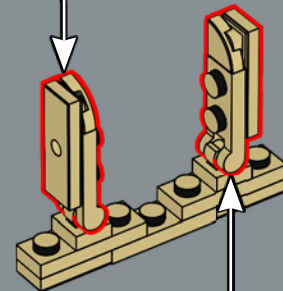
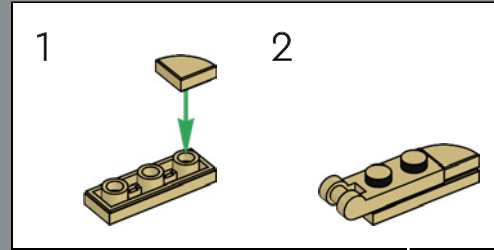

355

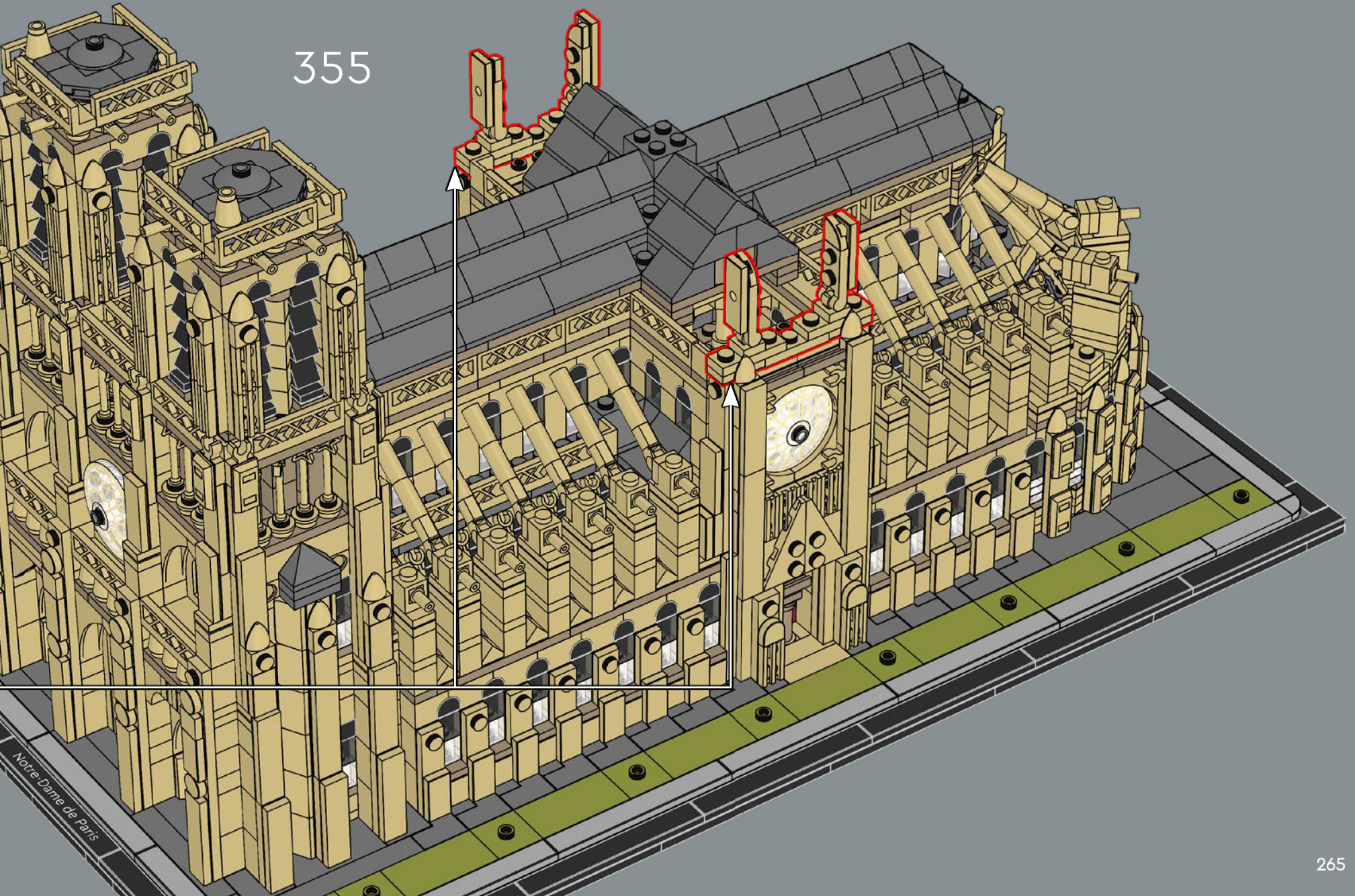

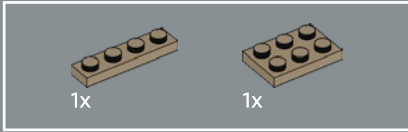
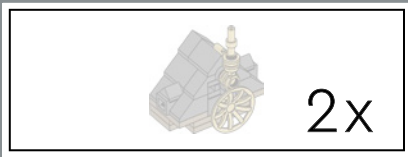

356

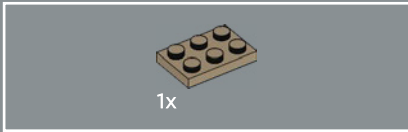
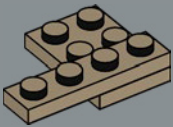

357

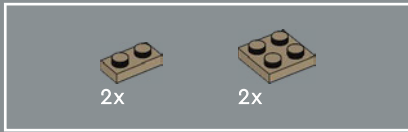
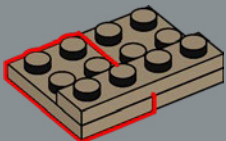

358

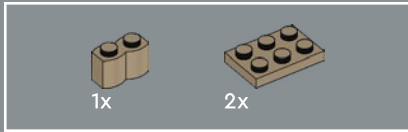
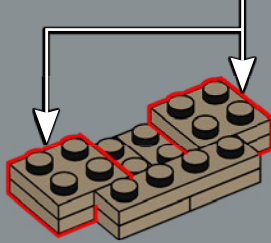
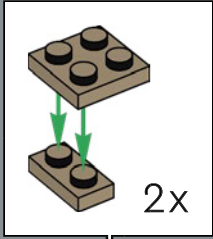

359

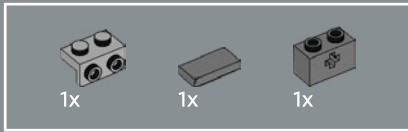
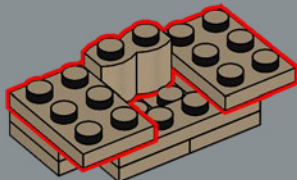

360

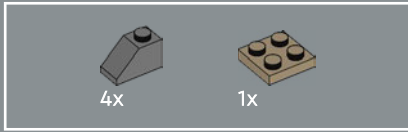
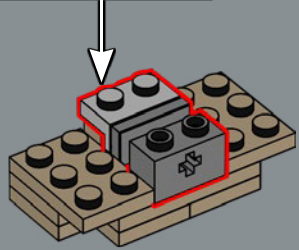
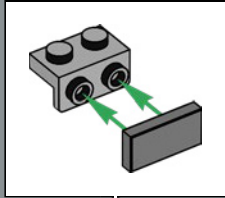

361

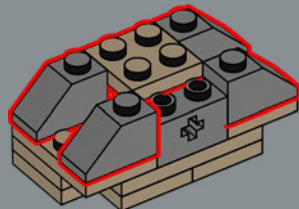

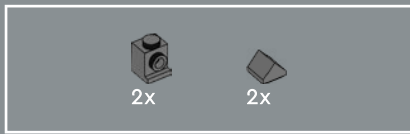

362

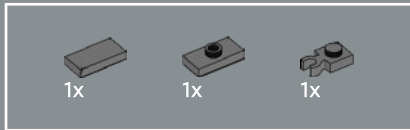
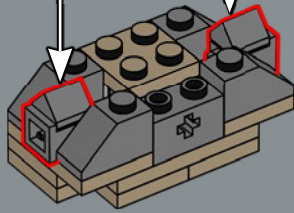
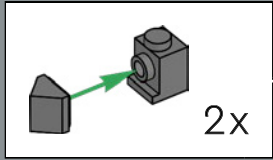

363

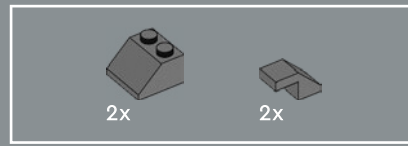
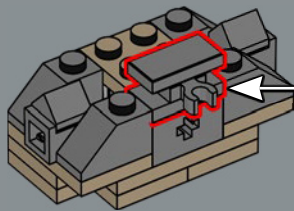
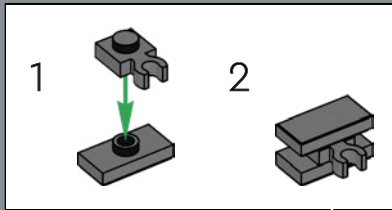

364

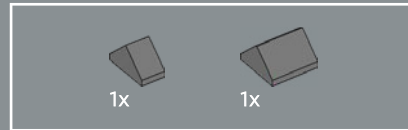
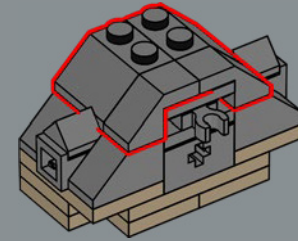

365

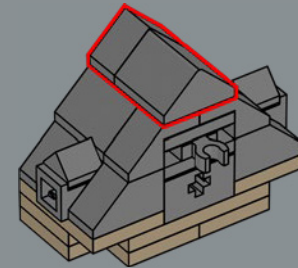



366

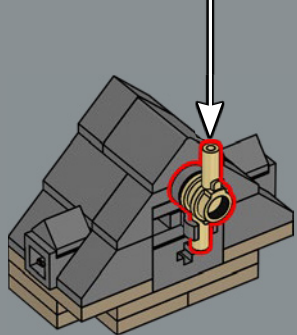
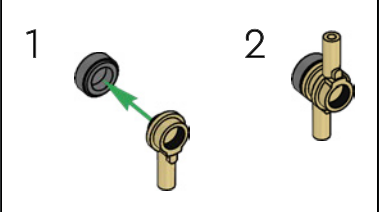

367

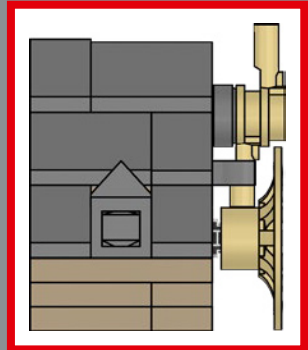
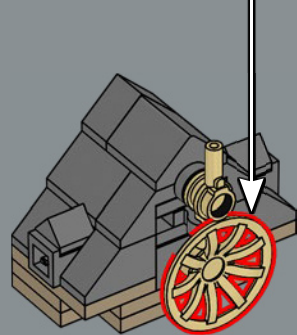
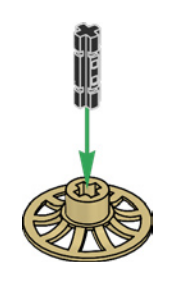

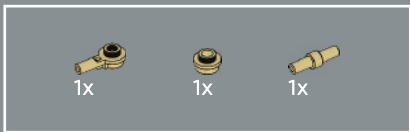

368

Los rosetones más pequeños se representan mediante elementos LEGO® de tapacubos.

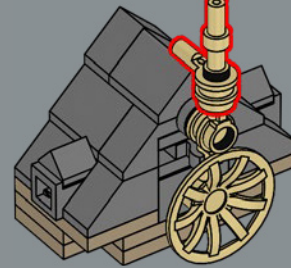
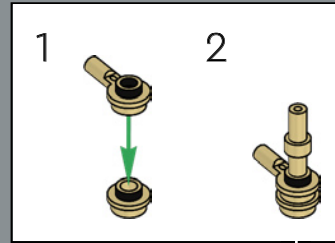

2x

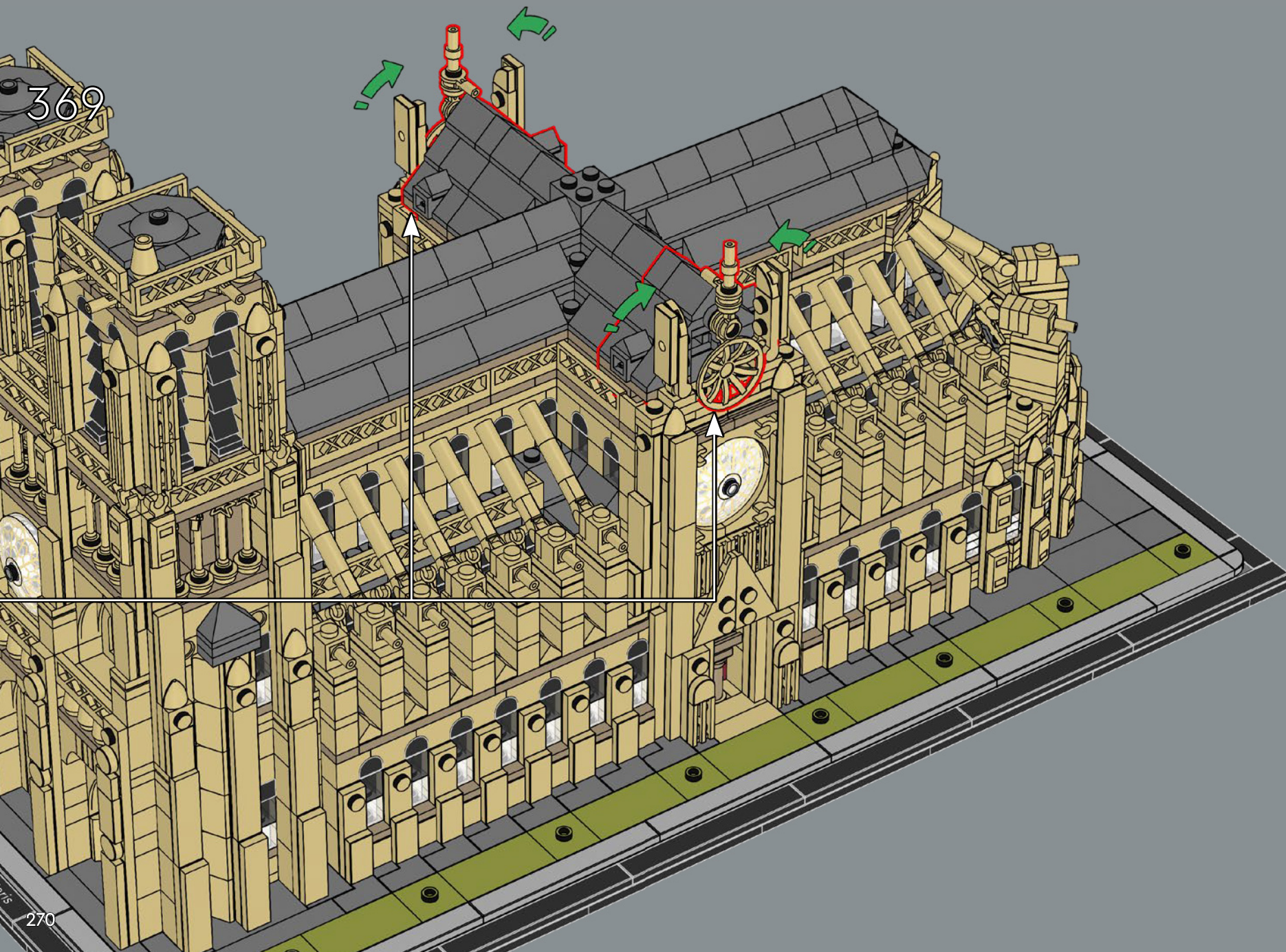

369

270

1245: Continúan las modificaciones y se añaden capillas laterales a lo largo de la nave principal.

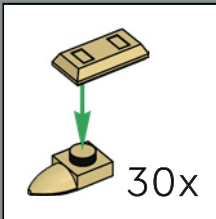

370



1789-1860



REVOLUCIÓN Y LEGADO CULTURAL

✂ Durante los turbulentos años de la Revolución francesa (1789-1799), la noble Catedral de Notre Dame sufrió daños y un deterioro gradual. Se destruyeron ventanas, altares y sepulcros, y algunas de las campanas fueron retiradas para fundirlas. En 1792, los revolucionarios derribaron las estatuas de la Galería de los Reyes y dismantelaron la aguja. Durante un tiempo, la catedral se usó incluso para almacenar vino y otras mercancías. No obstante, a raíz de la Revolución surgió una nueva conciencia y aprecio por el patrimonio nacional francés. La publicación y el éxito internacional cosechado por la novela *Nuestra Señora de París* (1831), de Víctor Hugo, consolidaron el estatus de la catedral como joya cultural de la historia universal. Entre 1843 y 1860, los arquitectos Jean-Baptiste Lassus y Eugene-Emmanuel Viollet-le-Duc sometieron la catedral a una extensa serie de restauraciones hasta convertirla en la versión que conocemos hoy en día.



371

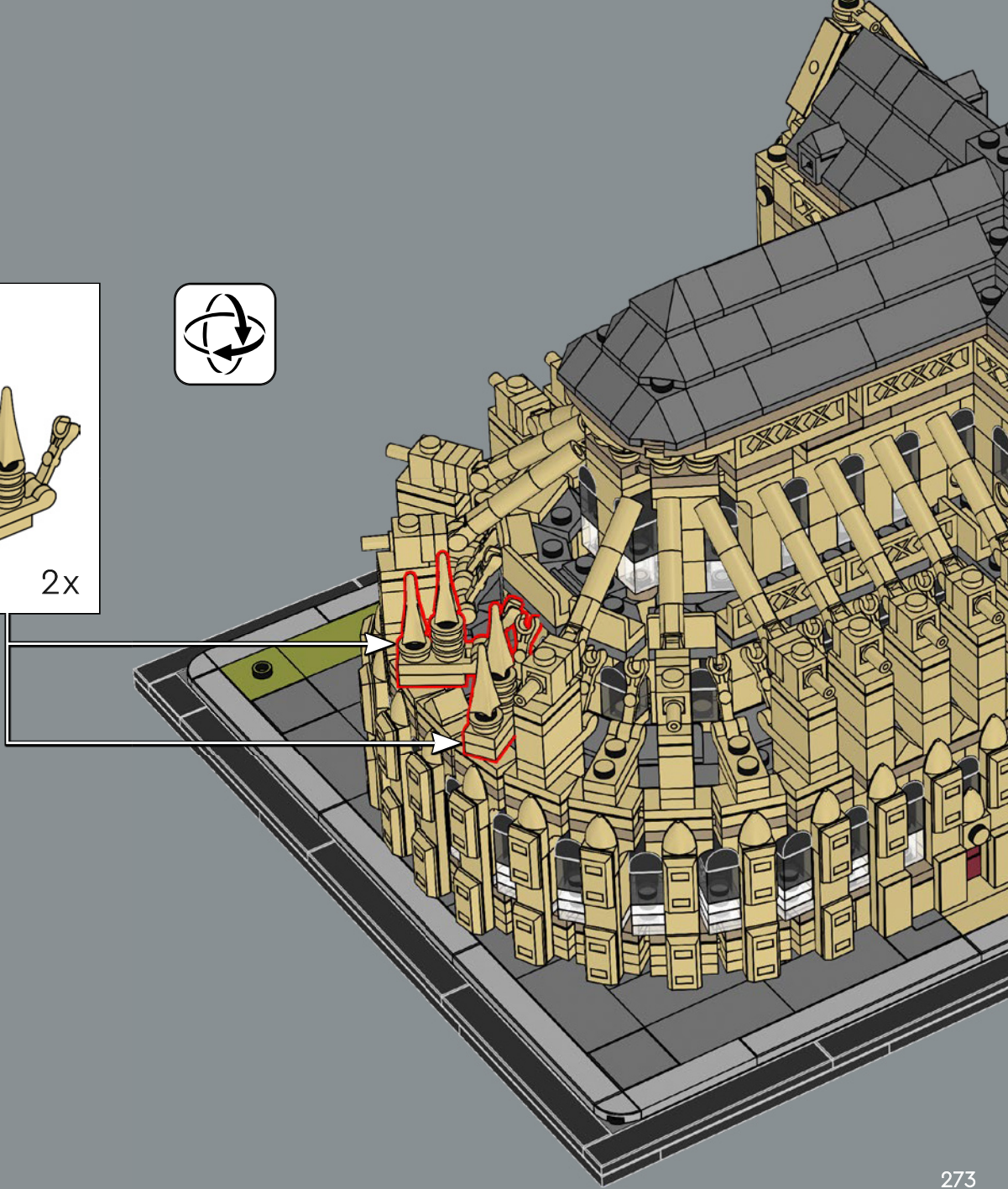
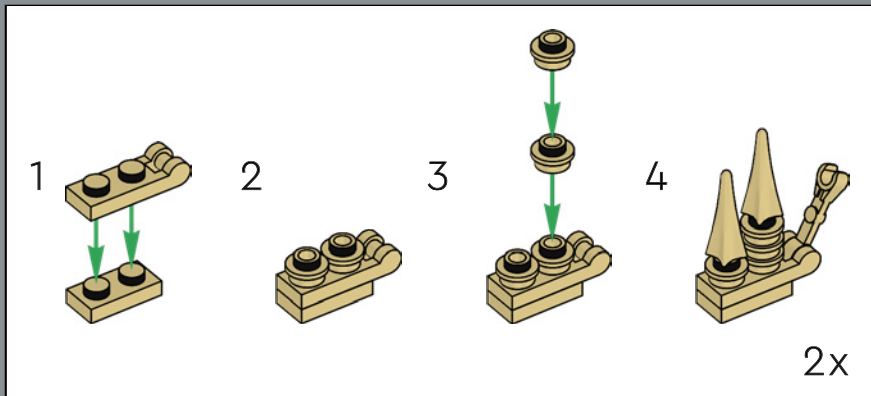



372

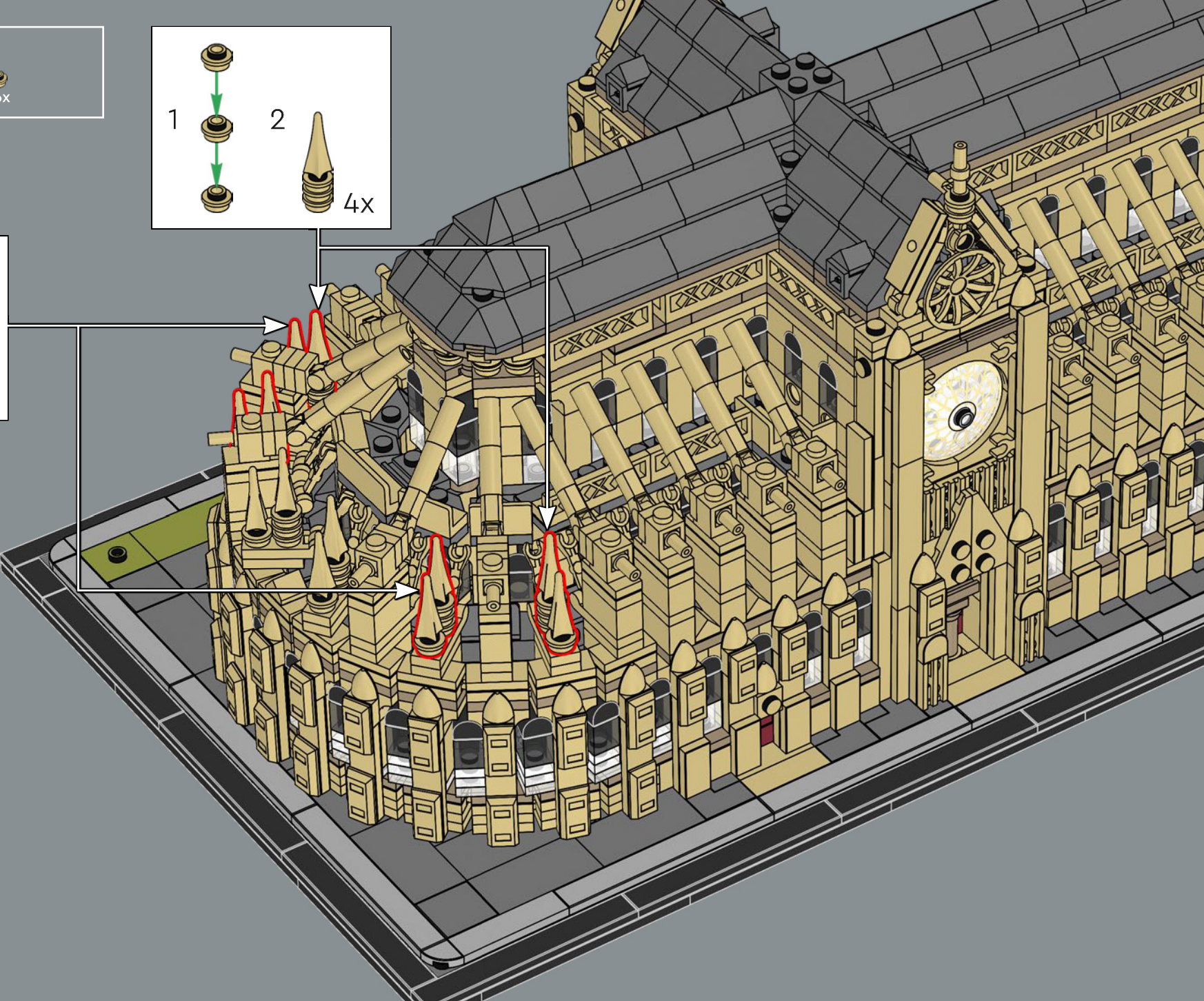
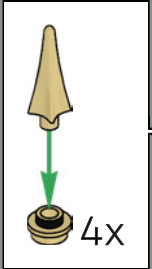
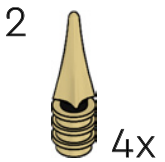
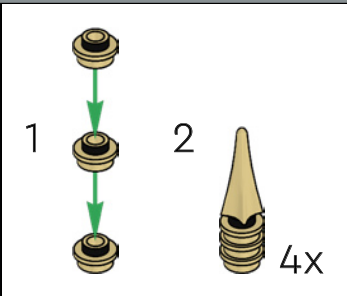



14x



28x

1350: Se terminan los últimos retoques de la Catedral de Notre Dame; los pináculos situados en los contrafuertes de los arbotantes se rehacen antes de sustituirlos de nuevo en el siglo XIX.

373

1



2



14x

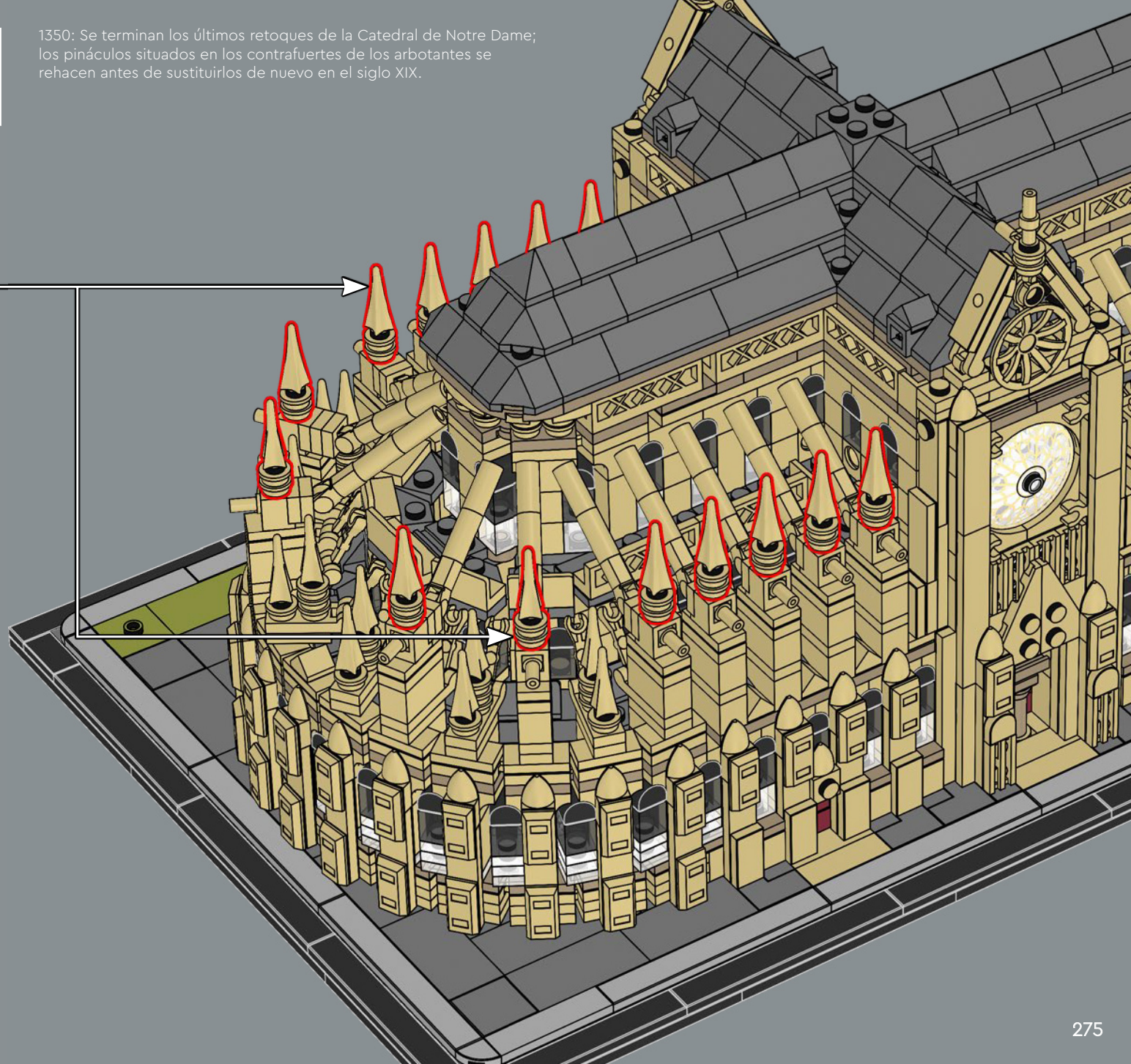



374

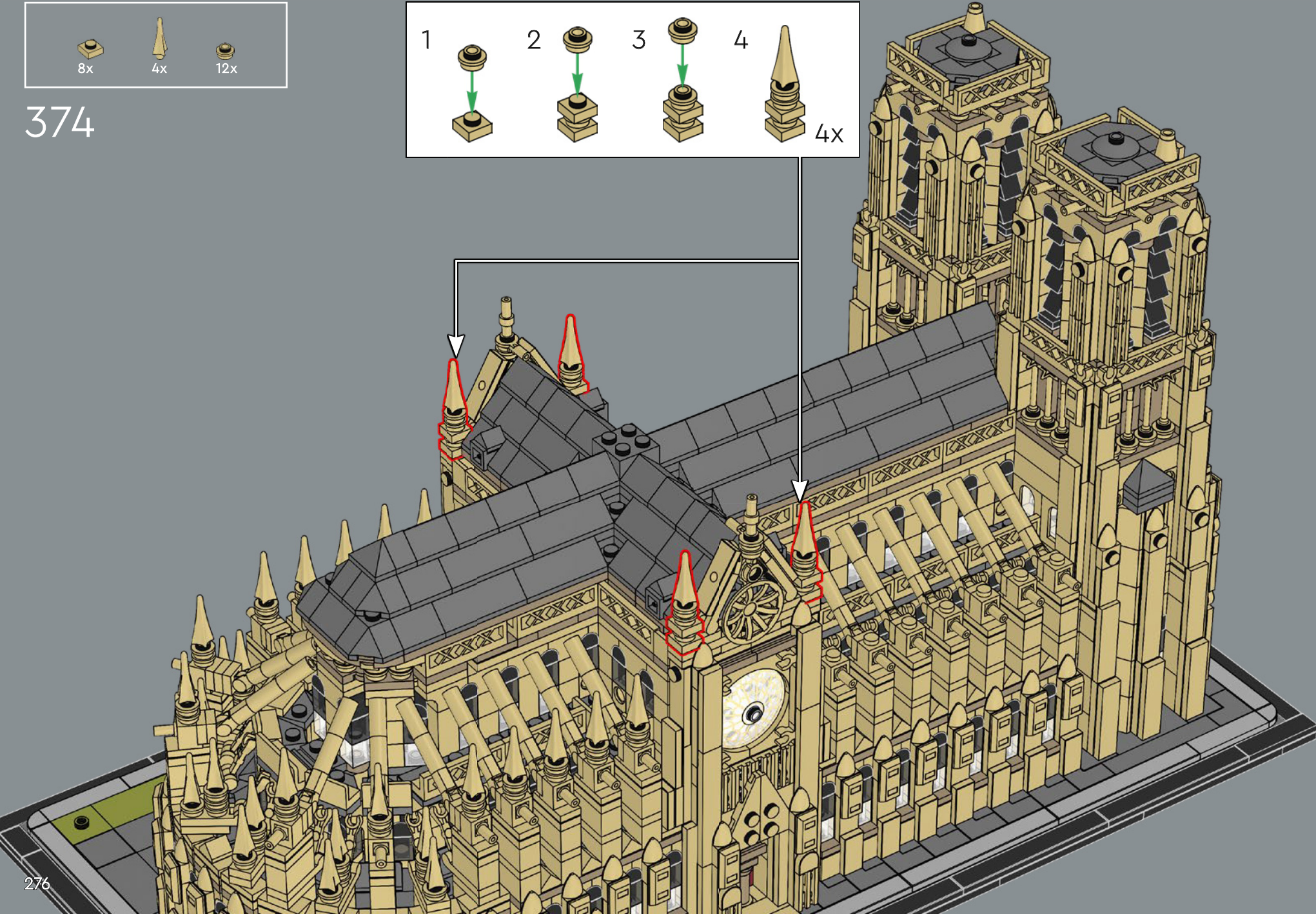
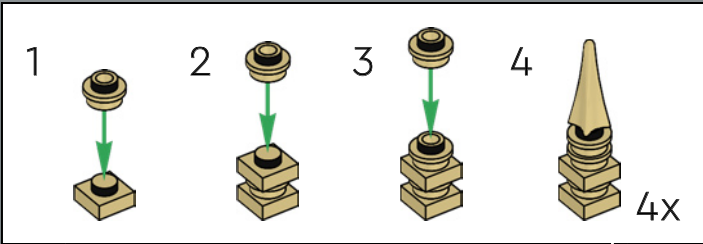



14x



14x

1858: Jean-Baptiste Lassus y Eugene-Emmanuel Viollet-le-Duc
añaden tabernáculos a los arbotantes.

375



14x

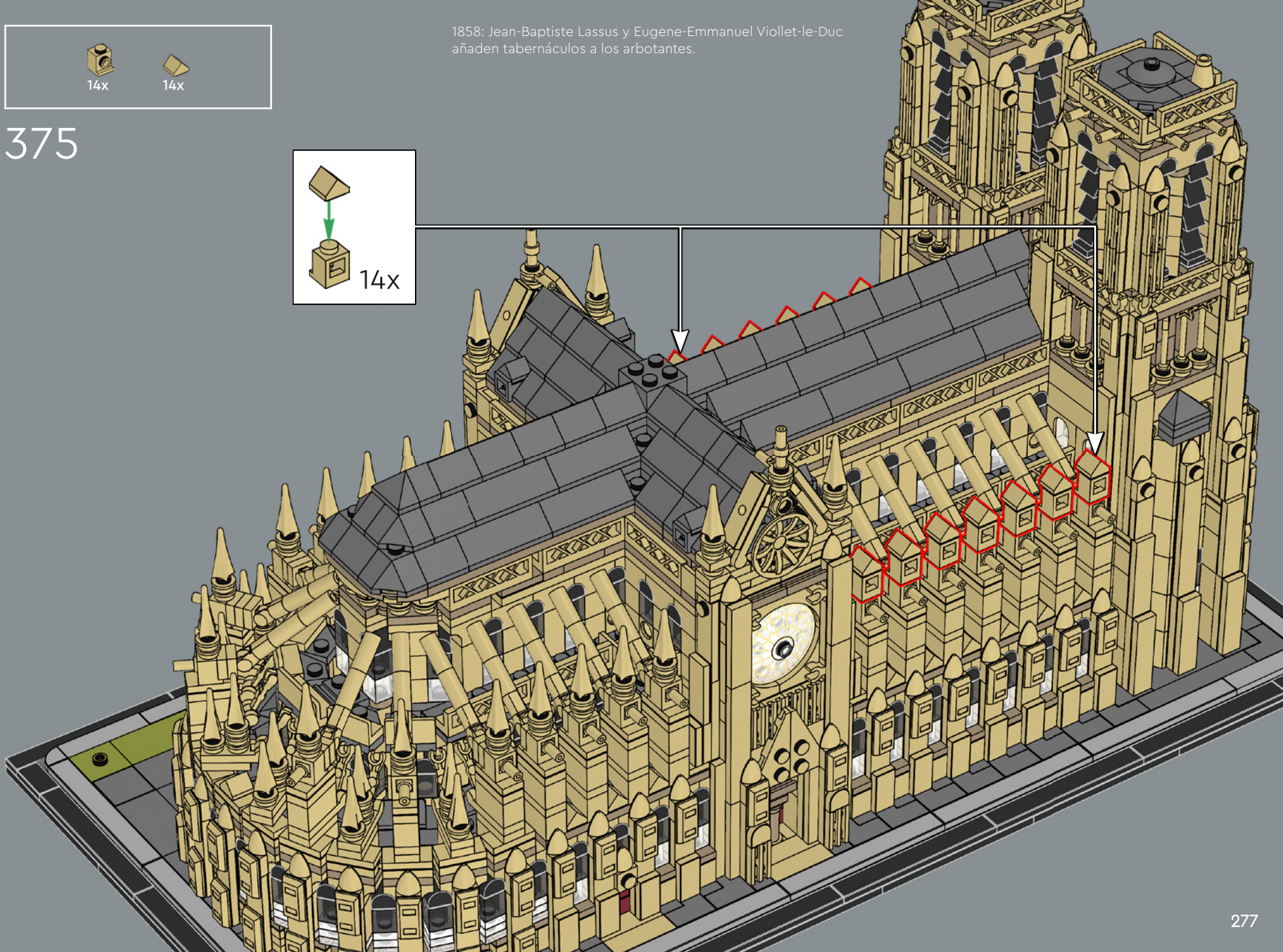

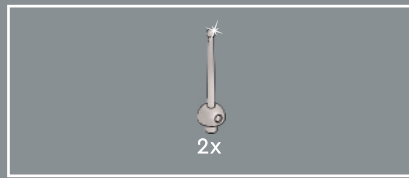

376

Con una altura de 69 m, las dos torres de la fachada occidental convirtieron a la Catedral de Notre Dame en el edificio más alto de París hasta la construcción de la Torre Eiffel (1887-1889).

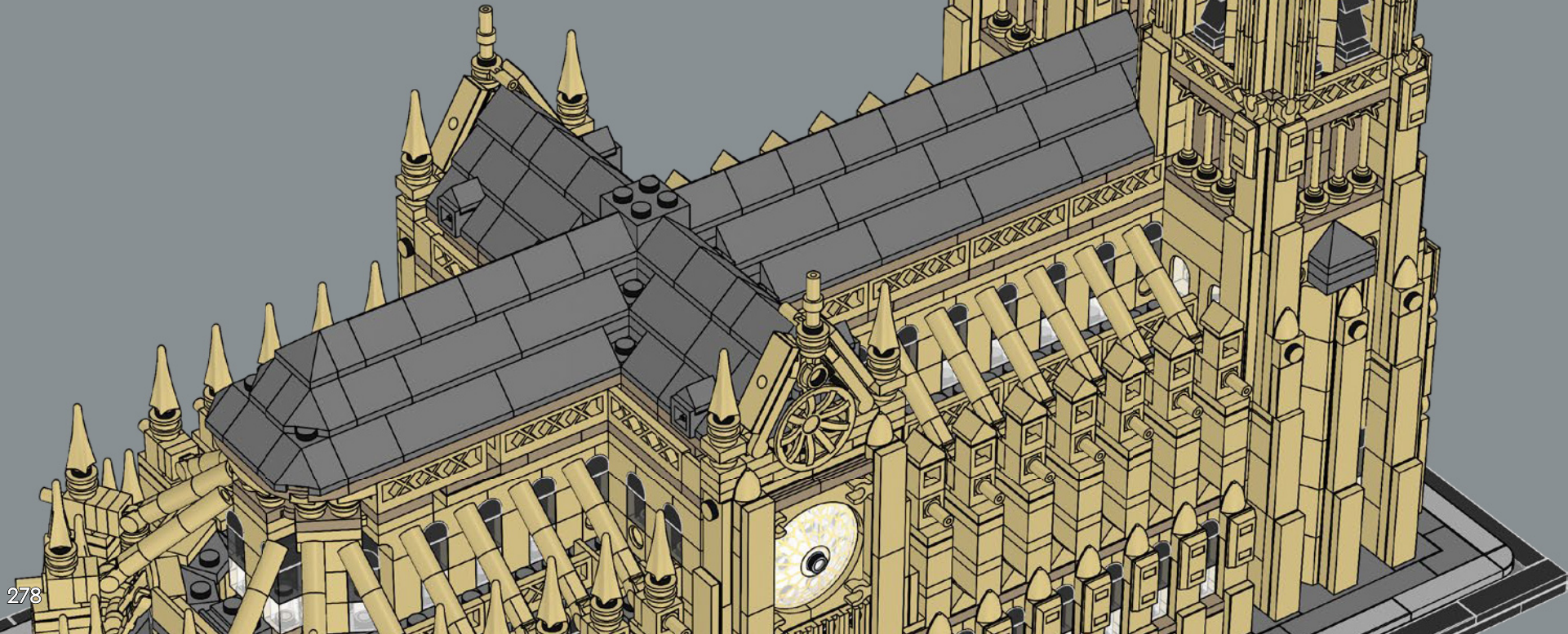



8x

377

1843-1860: Importante restauración a cargo de Jean-Baptiste Lassus y Eugene-Emmanuel Viollet-le-Duc.

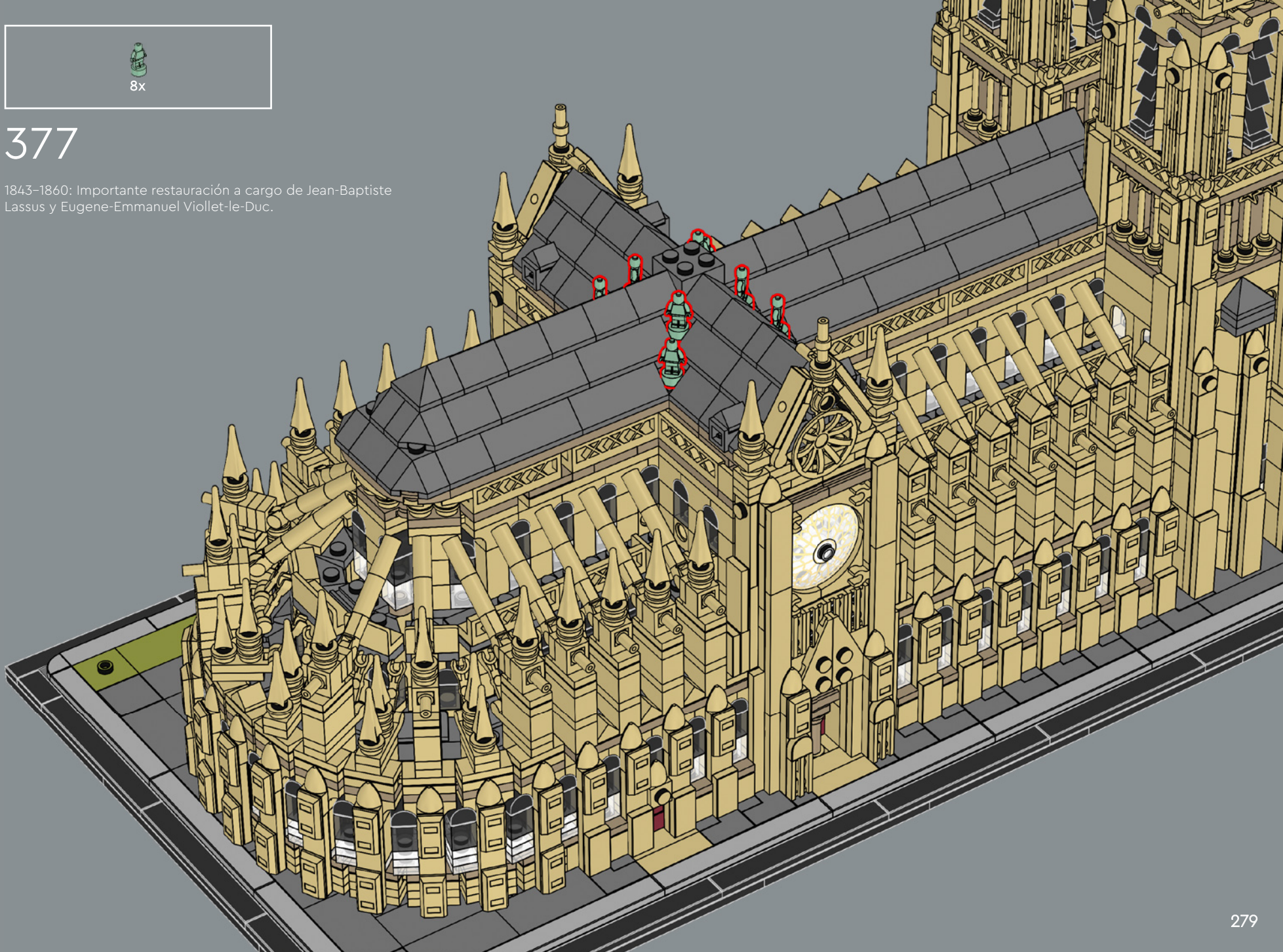



- 2x 
- 1x 
- 1x 
- 8x 



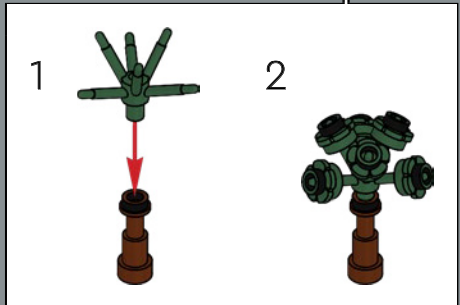
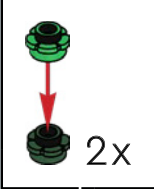

378



 18x
 3x
 3x

379



1 
 2 
 3x



2x



6x



36x



24x



4x



2x



2x

380

Dimensiones actuales de la Catedral de Notre Dame: anchura de la fachada: 43,5 m; anchura de la nave transversal: 48 m; longitud total: 128 m; altura de la aguja: 96 m; altura de las torres: 69 m; altura del tejado de la nave: 35 m.

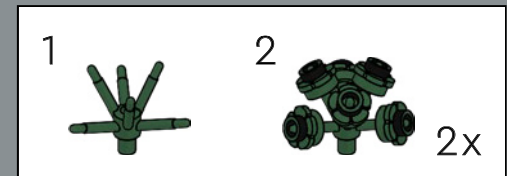
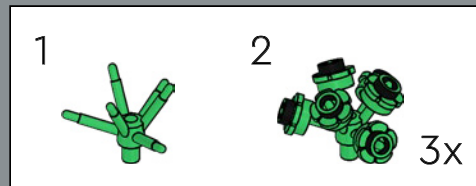

1



2

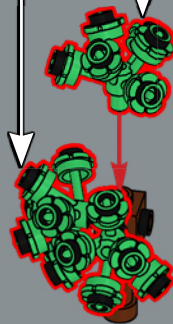

3

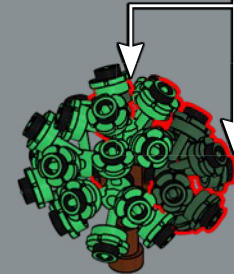

2x



Notre-Dame de Paris

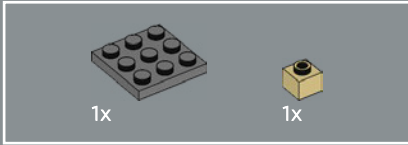
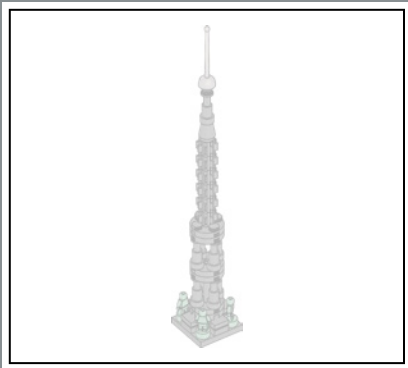

381

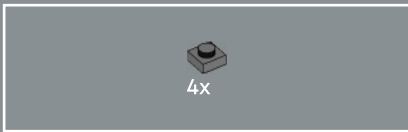
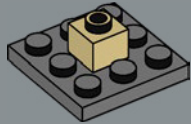

382

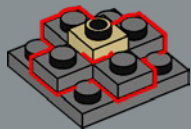

383

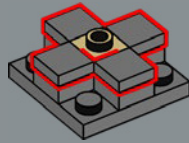

384

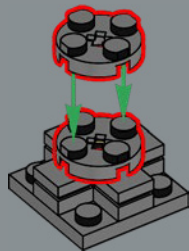

385

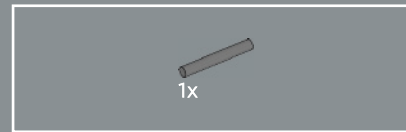
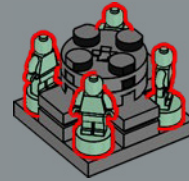

386

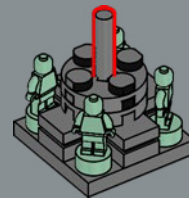



387

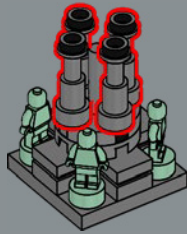

389

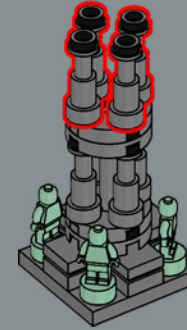

388

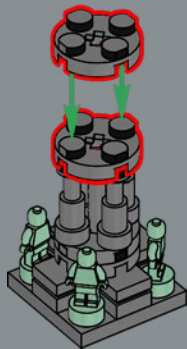

390

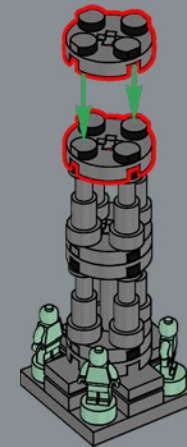

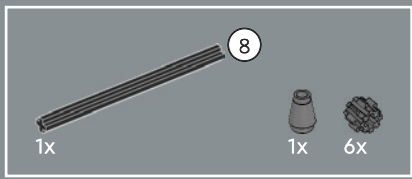

391

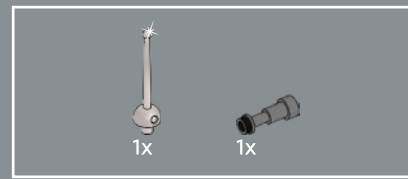
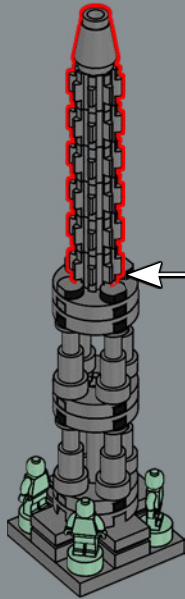
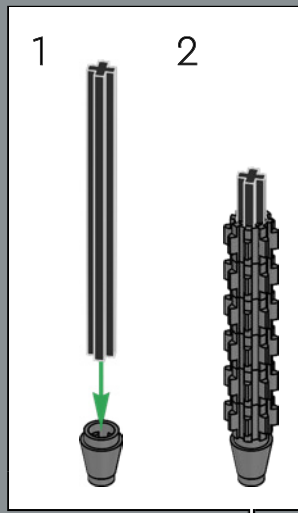

392

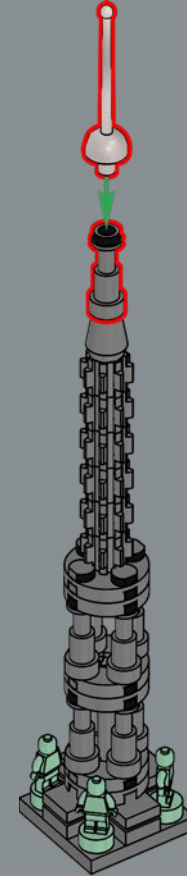

Las puertas delanteras del modelo LEGO® de la Catedral de Notre Dame están abiertas para que podamos asomarnos y sentir el asombro que experimentaríamos al incursionar en el elaborado y vasto entramado de arcos de su interior.

393

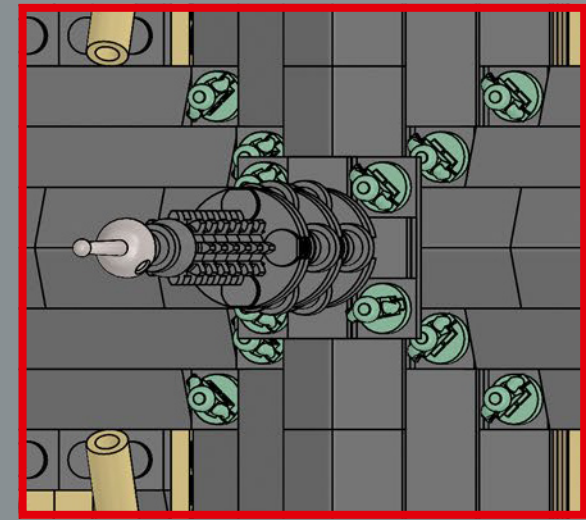

La única estatua que mira hacia la aguja tiene el rostro de Eugene-Emmanuel Viollet-le-Duc, uno de los arquitectos de la catedral. Contempla la aguja en señal de admiración por el edificio, mientras las demás estatuas vigilan París.



INCENDIO Y RECONSTRUCCIÓN

Tras el devastador incendio de abril de 2019, la Catedral de Notre Dame se vio obligada a cerrar indefinidamente a la espera de su reconstrucción. Mientras el mundo observaba cómo los equipos de rescate extinguían el fuego, múltiples campañas de recaudación de fondos a escala mundial reunieron, en un tiempo récord, ingentes sumas para llevar a cabo los extensos trabajos de reconstrucción. Este hecho es testimonio de la huella imborrable que la Catedral de Notre Dame ha dejado en personas de todas las culturas a lo largo de su vida, y del incomparable espíritu de París. Con casi 900 años de historia reunidos en más de 4000 elementos LEGO®, nos complace incluir este modelo en nuestra colección LEGO Architecture.



6x
4616711



80x
6300322



8x
6231386



12x
6449564



1x
6167854



2x
6300321



8x
6458397



32x
6446790



5x
6398343



5x
6264025



1x
6341471



2x
6133765



7x
6428178



6x
6310449



1x
4211389



2x
6267495



6x
4211511



2x
4213567



6x
6383177



4x
6401023



4x
4211356



6x
4211445

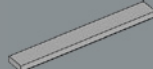

16x
4211481



2x
4654582



2x
6469440



4x
6176433



12x
6335936



4x
4211098



1x
4211088



3x
4211060



1x
4211085



4x
4211044



4x
4558955



18x
4535930



22x
4211127



12x
4210848



4x
4210719



9x
4211063



14x
4211052



14x
6092572



16x
4210635



2x
6126083



2x
6309059



6x
6177079



10x
4211094



2x
4211055



31x
6247784



31x
6343852



4x
4568734



1x
4211133



12x
4211043



2x
4211053



19x
6039176



4x
6307616



19x
4560184



5x
42110651



1x
4243831



2x
4210998



1x
4211115



1x
4211134



2x
6296892



1x
4543086



9x
6284596



2x
4210633



4x
6221607



3x
4210872



3x
4210869



6x
4211042



2x
4211010



10x
6164073



2x
4527082



1x
6310596



9x
6396412



6x
6012451



20x
4211045



6x
4218188



2x
4210678



20x
4211114



3x
6222063



8x
6212080



8x
6016488



86x
6470140



24x
6446336



[LEGO.com/service](https://www.lego.com/service)



YOU COULD WIN



YOU COULD WIN

Your feedback will help shape the future development of this product series.

Visit:

DU KÖNNTEST GEWINNEN

Dein Feedback trägt zur Weiterentwicklung dieser Produktreihe bei.

Geh auf:

VOUS POURRIEZ GAGNER

Vos commentaires nous aideront à concevoir les futurs produits de cette gamme.

Visitez :

POTRESTI VINCERE TU

La tua opinione ci aiuterà a migliorare la creazione futura di questa linea di prodotti.

Visita:

PUEDES GANAR

Tu opinión contribuirá al futuro de esta serie de productos.

Visita:

轻松获奖

您的反馈将有助于我们在今后改进本产品系列。

请访问:

[LEGO.com/productfeedback](https://www.lego.com/productfeedback)

You also have the chance to win a LEGO® set.

Terms and conditions apply.*

Außerdem hast du die Chance, ein LEGO® Set zu gewinnen.

Es gelten die Teilnahmebedingungen.*

Vous pourriez également gagner un ensemble LEGO®.

Des conditions s'appliquent.*

Hai anche la possibilità di vincere un set LEGO®.

Termini e condizioni sono applicabili.*

También tienes la oportunidad de ganar un set LEGO®.

Aplican términos y condiciones.*

您还有机会赢取乐高®套装。

条款和条件适用。*

*[LEGO.com/productfeedback-terms](https://www.lego.com/productfeedback-terms)

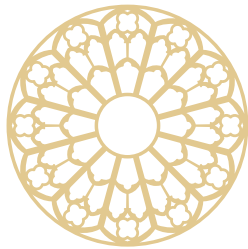

LEGO and the LEGO logo are trademarks of the LEGO Group. ©2024 The LEGO Group.
Adam Reed Tucker is the co-developer of the LEGO® Architecture product line.